

***SPRING CREEK<sup>TM</sup>  
PRODUCTS***

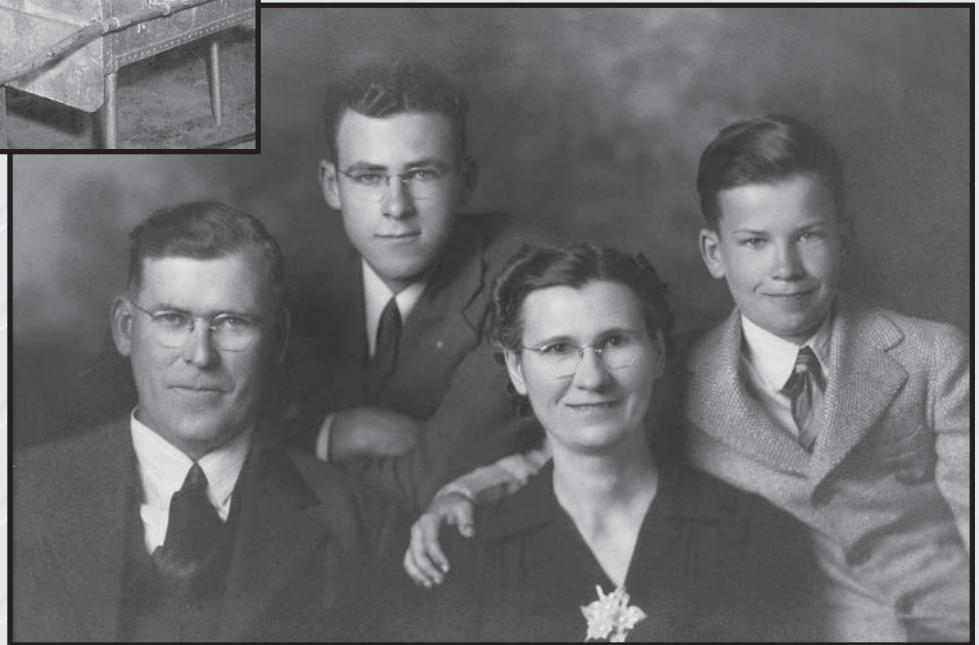

**2024 CATALOG**



## Our History

We've been in the steel business for three generations. My grandfather, Walter F. Mueller, owned a small sheet metal shop and hardware store in Moulton, Texas, during the Great Depression. With the help of his two sons—my father, Harold, and my uncle, James—the family grew the enterprise into a great West Texas success story: Mueller Supply Co.

It was not an easy go. My dad remembers times when the family was so poor they ate “everything but the squeal” when they butchered a hog.

Fortunately, the Muellers knew how to work hard and find success in unlikely opportunities. When they discovered they could buy bent salvage rebar and angles at low prices, they invented a machine to straighten them out for resale. Hard work and unorthodox thinking allowed them to consistently make “a silk purse out of a sow’s ear.”

My dad and uncle sold Mueller Supply Co. in 1984, the year after I started my own business, Mueller Metals, LLC. We sell and trade steel worldwide. Mueller Metals recently was named one of the largest U.S. importers of Mexican light-walled square and rectangular tubing.

In 2007, Mueller Metals opened Spring Creek™ Products, a division dedicated to delivering our steel customers an economical line of farm and ranch-related gate hinges, latches, fencing products, safety products, welding supplies, industrial hardware, ornamental items, tie-down accessories, and our Total Cut® Pipe Guides. We constantly add quality, low-cost, proven winners to our warehouse in Wall, Texas.

We appreciate your business and work hard in the Mueller tradition to earn it every day.

*Fred Mueller*



# Check Out What's New With



# SPRING CREEK<sup>TM</sup> PRODUCTS

## Latches.....1-7

#81103 - T-Handle Spring Latch 6" x 1".....	2
#81589 - Heavy-Duty Slide Bolt Latch 5".....	4
#81565 - Gate Drop Latch With 8" Handle.....	4
#81110 - Toggle Clamp 5" With Quick Release.....	5
#81424 - Heavy-Duty Pull Down Latch.....	5
#81570 - Decorative Gate Hook Latch 6".....	5
#81566 - 2-3/4" Heavy-Duty Gravity Latch.....	6
#81063 - Latch Keeper 2-1/2" Zinc.....	7
#81082 - Gate Striker Plate For 7/8" Bare.....	7

## Hinges.....8-22

#80197 - Hinge Sleeve For 6.625"OD.....	17
#80078 - Hinge Sleeve For 1.315" OD.....	17
#81568 - Tee Hinge 3" Black.....	20
#81588 - Heavy-Duty Tee Hinge 6" Black.....	20
#81569 - Heavy-Duty Tee Hinge 12" Black.....	20
#81102 - 5/8" x 8" J-Bolt Zinc.....	21
#81076 - Post Hinge 2-3/8" x 3/4" x 1".....	22
#81077 - Post Hinge 2-7/8" x 3/4" x 1".....	22
#81113 - Female Hinge 5/8" x 1-5/8" Zinc.....	22

## Panels.....23-24

#81106 - Bent Corral Pin 1/2" x 9" Zinc.....	24
#81104 - 81105 - Corral Post Brackets.....	24

## Gates.....25-26

#81112 - Cane Bolt Kit 3/4" x 12" Bare.....	25
#81567 - Cane Bolt 1/2" x 18" With Bracket.....	25

## Wheels.....27-29

#81127 - Bolt 3-1/2" x 1/2" With Grease.....	28
--	----

## Fencing.....30-38

#81429 - Barbed Wire Roller.....	30
#81477 - 81478 - Wire Stay Fence.....	30
#80382 - Fence Connectors Offset 1.05" OD.....	31
#81117 - Fence Clip 2-7/8" x 3/8".....	33
Plastic Tubing Plugs.....	34
#80661 - Colonial Iron Hinge 4-1/2" x 20".....	40
#80670 - Barcelona Hinge Strap 22".....	40
#80671 - Barcelona Hinge 6-1/4".....	40
#80674 - Classic Iron Hinge 2" x 2".....	40
#80658 - Hammered Offset Hinge 2-1/2" x 5".....	40
#80678 - Italian Iron Hinge 4-1/2".....	40
#80650 - 80651 - Hammered Nails.....	41
#81571 - Garage Decorative Hardware Kit.....	41
#80665 - Hammered Straight Handrail.....	41
#80668 - Stud Iron Post Cap 4".....	41
#80682 - Italian Post Cap 4".....	41
#81151 - Decorative H Hinge.....	42
#81590 - Gate Handle 5-3/4".....	43
#81685 - 81686 - Cast Iron Braces.....	45
Corner Braces.....	45
Mending Plates.....	46
Metal Art.....	49

## Fencing.....51-56

#81065 - Horstall Channel Bracket.....	51
#81625 - 81630 - AR500 Targets.....	53

#81075 - Rain Gauge.....	53
#81055 - 81059 - Grilling Tools.....	54

## Trailer Lights.....57-61

Round Clearance & Marker Lights.....	57
Rectangular Clearance & Marker Lights.....	57
Square Clearance & Marker Lights.....	57
Oval Clearance & Marker Lights.....	57
Square Stop / Turn / Tail / License Lights.....	58
#81385 - Round Stop / Turn / Tail Light.....	58
Oval Stop / Turn / Tail Lights.....	58
Ship / Turn / Marker Lights.....	59
Stop / Turn / Tail Light Bars.....	59
Oval Back Up Lights.....	59
#81618 - Round Back Up Light.....	59
Indicator Light Bars.....	59
Round License Plate Lights.....	60
Square License Plate Lights.....	60
Round Grommets.....	60
7 Way Plugs & Sockets.....	60
Light Plugs.....	60
#81420 - Break-a-way Switch.....	61
4-Way Round Wire.....	61
7-Ways With Wire.....	61
Rolled Wires.....	61
#81602 - Harness Clip.....	61
#81418 - 7-Way Junction Box.....	61
#81422 - Quick Splice.....	61

## Trailer Parts.....62-64

#81421 - Trailer Light - 4" Square Bracket.....	62
#81453 - 6" Oval Light Box With 2" Round.....	62
#81401 - License Plate Bracket.....	62
#81414 - 81415 - Reflective Tapes.....	62
#81365 - Gooseneck Tow Ball.....	63
#81094 - 81096 - Trailer Fenders.....	63
#80995 - 4-Hole Channel.....	64
#81092 - Bolt & Nut Set 4-7/16" x 5/8".....	64
#80991 - Weld-On Stake Pocket 4ga.....	64
#81083 - Rope Hook 1/4" x 2-1/4".....	64
#80999 - 81002 - Torsion Springs.....	64

## Trailer Jacks.....65

Round Trailer Jacks.....	65
Square Trailer Jacks.....	65
Wheeled Trailer Jacks.....	65

## Chain.....66

#81091 - Safety Chain 5/16" x 30".....	66
--	----

## Connectors.....67-74

#81111 - Weld-On "C" Hook 5/8".....	68
#81591 - Chain Retainer 1/2".....	68
#81476 - Threaded Bent Bolts.....	74

## Straps.....75-76

#81502 - 81503 - Multi-purpose Zip Ties.....	75
#81561 - Bungee Cord.....	75
Recovery Tow Straps.....	76

## Building.....66

#81428 - Outlet Adapter Tube 1-1/2".....	80
--	----

## Welding Gear.....81-82

#81098 - 81099 Sugar Scoop Welding Helmet.....	81
--	----

## Tools.....83-89

#81149 - Victor Style Heating Assembly.....	86
#70276 - Saddle Series Cutting Guide 2-7/8".....	89

## Fabricated Items.....90-101

#81118 - 81120 - Gusset Cuts.....	91
#81121 - 81126 - Triangular Die Cuts.....	92
#81458 - Square Weld Flange 5-1/4".....	94
#81084 - Weld Tab 3/8" Double Hole.....	95
#81668 - 81671 - Weld Tabs.....	95
#81452 - Weld Tab 2-3/8" x 2".....	95
Radius Surface Mount Tabs.....	97-98
Triangular Radius Surface Mount Tabs.....	99-100
#81433 - Triangular Radius Tab.....	100
Flat Surface Mount Tabs.....	101
#81432 - Flat Surface Mount Tab.....	101
Triangular Flat Surface Mount Tabs.....	101

## Abrasives.....105-110

Stringer Bead Wire Wheels.....	107
#81620 - Brute XL12 Silver & Deming Drills.....	111
#81147 - 81148 - Masonry Drills.....	112
#81651 - Columbia Annular Cutter 15/16" x 1".....	113
#81427 - Carbide Tipped Hole Cutter Set.....	113
Brute Maintenance Reamers.....	114
#81609 - Brutelube Cutting Fluid 4oz.....	114
#81610 - Brutelube Wax Lubricant.....	114

## Hand Tools.....111-114

#81631 - 81633 - Conversion Rulers.....	116
#81081 - Steel Framing Squares.....	116
Speed Squares.....	116
#81066 - Line Level Set.....	116

## Shop Gear.....122-126

Driver Gloves Palm Lined.....	123
Mechanics Gloves - Top Grain.....	123
Mechanics Gloves - Superior.....	123
Premium Drive Glove - Super.....	123
#81639 - Mig Welding Glove Med.....	124
Dock Bumpers.....	125
Ready Hour Meal Prep.....	126

See the newest items on  
our website!



## Hablamos Español

## Spring Bolt Latches - Aluminum Base

Item #	Style	Size (Length x Width)	Pin	Finish (Base/Pin)	Wt. lbs.	Qty.
#50294	Right	7" x 1-5/8"	3/8"	Bare/SS	0.36 lbs.	100
#50295	Left	7" x 1-5/8"	3/8"	Bare/SS	0.36 lbs.	100

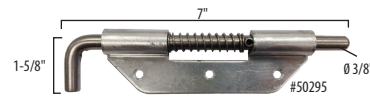

## Spring Latch With Rubber Grip - Aluminum Base

Item #	Size (Length x Width x Height)	Pin	Finish (Base/Pin)	Wt. lbs.	Qty.
#50381	7" x 1-1/2" x 1-1/2"	1/2"	Bare/SS	0.55 lbs.	25

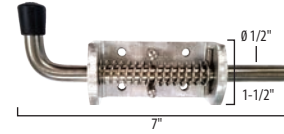

## Spring Latch With Welded Tab

Item #	Size (Length x Width)	Pin	Finish	Wt. lbs.	Qty.
#49104	2-5/8" x 1-5/8"	1/2"	Bare	0.27 lbs.	10

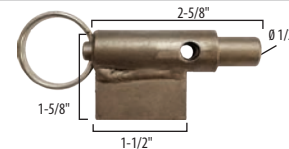

## Spring Latches With Weld Plate

Item #	Size (Length x Height)	Pin	Finish (Weld Plate)	Wt. lbs.	Qty.
#50632	4-5/8" x 1-1/2"	5/8"	Bare	0.67 lbs.	20
#47016	6-1/4" x 1-1/2"	5/8"	Bare	0.81 lbs.	20
#50660	6-3/16" x 1-1/2"	5/8"	HDG	0.90 lbs.	20

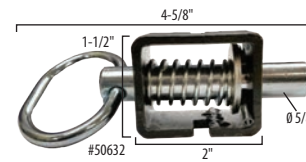

## Spring Horseshoe Latches

Item #	Size (Length x Width)	Pin	Finish	Wt. lbs.	Qty.
#50380	11-1/4" x 3/4"	1/2"	Bare	1.27 lbs.	20
#50383	14-1/2" x 1-1/4"	1"	Bare	3.15 lbs.	10



## Spring Latches With Handle

Item #	Type	Size (Length x Width)	Pin	Finish	Wt. lbs.	Qty.
#49836	Square	13-1/4" x 1-1/4"	7/8"	Bare	2.56 lbs.	10
#49837	Round	13-3/8" x 1-3/8"	1"	Bare	2.85 lbs.	10

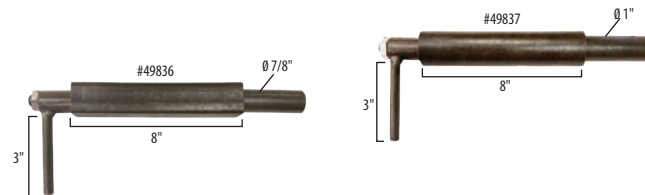

## Slam Action Latch And Keeper

Item #	Size (Length x Width)	Pin	Finish	Wt. lbs.	Qty.
#50305	5-1/2" x 2-1/8"	1"	Stainless Steel	1.17 lbs.	20

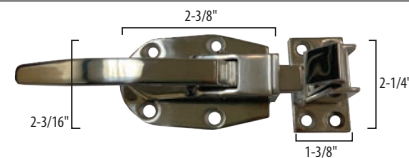

## Spring Latch With Rubber Grip

Item #	Size (Length x Width x Height)	Pin	Finish	Wt. lbs.	Qty.
#47671	6-5/8" x 2-3/4" x 1-5/16"	1/2"	Zinc	0.74 lbs.	12

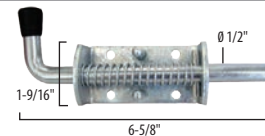

## Spring Latches Without Rubber Grip

Item #	Size (Length x Width)	Pin	Finish	Wt. lbs.	Qty.
#50346	5-1/4" x 1-3/4"	1/2"	Zinc	1.00 lbs.	20
#50347	6" x 2"	3/4"	Zinc	2.10 lbs.	20

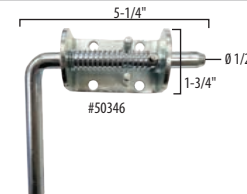

## Spring Latches - Bent Pin

Item #	Style	Size (Length x Width)	Pin	Finish	Wt. lbs.	Qty.
#50348	Left	6-3/4" x 3-3/16"	1/2"	Zinc	0.84 lbs.	45
#50349	Right	6-3/4" x 3-3/16"	1/2"	Zinc	0.84 lbs.	45





## Spring Latches With Pull Ring

Item #	Size (Length x Width)	Pin	Finish	Wt. lbs.	Qty.
#46990	11-1/4" x 1"	3/4"	Zinc	1.51 lbs.	10
#49328	11-1/4" x 1-1/4"	1"	Zinc	2.44 lbs.	10

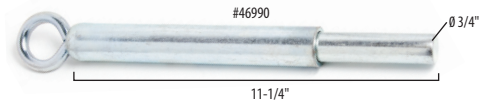

## Spring Latches T-Handle

New

Item #	Size (Length x Width)	Pin	Keeper	Finish	Wt. lbs.	Qty.
#81103	6" x 1"	5/8"	No	Zinc	0.71 lbs.	50
#47339	8-3/4" x 1"	3/4"	Yes	Zinc	3.05 lbs.	8

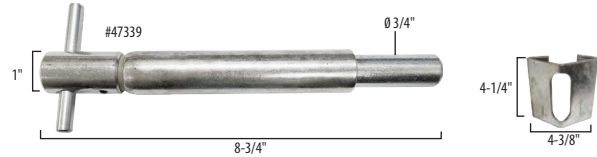

## Spring Latches With Round Handle

Item #	Type	Size (Length x Width)	Pin	Finish	Wt. lbs.	Qty.
#49831	Latch	5" x 1"	5/8"	Zinc	0.58 lbs.	100
#50017	Knob	1-3/8"	-	Plastic	0.08 lbs.	50

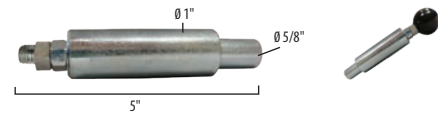

## Spring Latches With Tab

Item #	Size (Length x Width)	Pin	Finish	Wt. lbs.	Qty.
#49832	11-1/2" x 4"	1"	Zinc	2.90 lbs.	15
#80192	12-1/2" x 4"	1"	Zinc	2.91 lbs.	15



## Spring Latch - Double Barrel

Item #	Size (Length x Width)	Pin	Finish	Wt. lbs.	Qty.
#50287	10-1/16" x 1"	3/4"	Zinc	1.22 lbs.	25

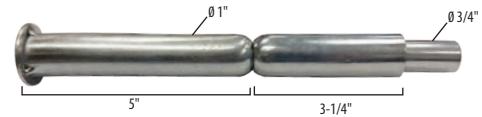

## Spring-Loaded Latch With P Handle

Item #	Size (Length x Width x Height)	Pin	Finish	Wt. lbs.	Qty.
#49875	7" x 2-1/8" x 1-1/2"	7/16"	Zinc	0.75 lbs.	20

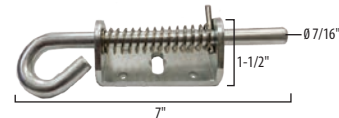

## Square Slam Action Latch

Item #	Size (Length x Width)	Pin	Finish	Wt. lbs.	Qty.
#50304	3-1/4" x 1-1/4"	3/8"	Zinc	0.18 lbs.	20

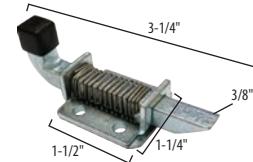

## Spring Latches With Key Ring

Item #	Size (Length x Width)	Pin	Finish	Wt. lbs.	Qty.
#47117	2-1/4" x 5/8"	1/2"	Zinc	0.18 lbs.	25
#49835	3" x 7/8"	5/8"	Zinc	0.56 lbs.	25
#50140	Replacement Ring	-	Zinc	0.03 lbs.	500



## Square Spring Latch With Chain

Item #	Size (Length x Width)	Pin	Finish	Wt. lbs.	Qty.
#49105	6-1/8" x 2"	1/2"	Zinc	0.50 lbs.	10

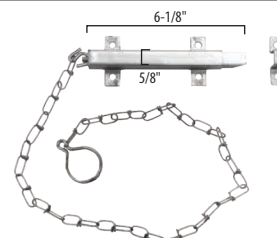

## Slam Action Gate Latches

Item #	Style	Size (Length x Width)	Pin	Finish	Wt. lbs.	Qty.
#47685	6" - Right	6-1/2" x 4-5/8"	3/4"	Bare	1.66 lbs.	12
#47686	6" - Left	6-1/2" x 4-5/8"	3/4"	Bare	1.66 lbs.	12
#50118	15" - Right	15-1/2" x 5-3/8"	1"	Bare	4.83 lbs.	4
#50134	15" - Left	15-1/2" x 5-3/8"	1"	Bare	4.83 lbs.	4

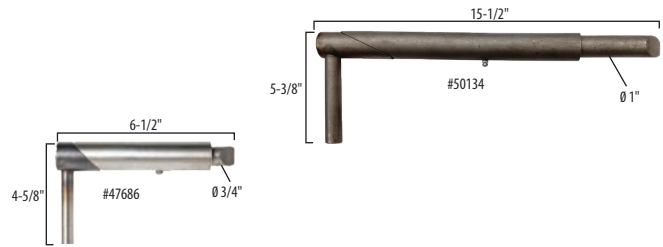

### Replacement Parts - For 6" only

Item #	Style	Wt. lbs.	Qty.
#49645	Plunger	0.49 lbs.	1
#49646	Handle	0.24 lbs.	1
#49647	Handle Mount	0.19 lbs.	1
#49649	Spring	0.02 lbs.	1
#49650	Grease Fitting	0.01 lbs.	1

## Stall And Trailer Latches

Item #	Style	Size (Length x Width)	Pin	Finish	Wt. lbs.	Qty.
#50070	4-1/2" - Left	4-1/2" x 5-7/8"	1/2"	Bare	0.88 lbs.	10
#50071	4-1/2" - Right	4-1/2" x 5-7/8"	1/2"	Bare	0.88 lbs.	10
#47017	6" - Left	6" x 6-3/16"	1/2"	Bare	0.69 lbs.	30
#47018	6" - Right	6" x 6-3/16"	1/2"	Bare	0.69 lbs.	30

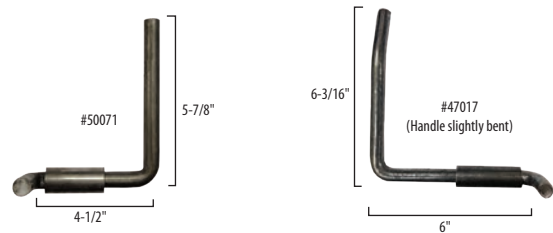

## Bar Gate Latches

Item #	Style	Size (Length x Width x Thickness)	Pin	Finish	Wt. lbs.	Qty.
#47619	10"	10-5/8" x 6-1/8" x 1-1/4"	5/8"	Bare	2.57 lbs.	10
#47593	17"	17-1/2" x 6" x 1-1/4"	5/8"	Bare	3.69 lbs.	10
#50149	17"	17-1/2" x 6-1/4" x 1-1/4"	7/8"	Bare	4.71 lbs.	10

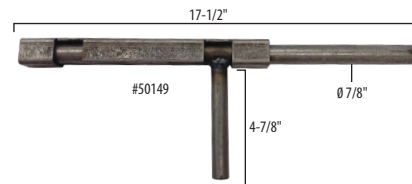

## Lockable Bar Gate Latch 12"

Item #	Pin (Length x Diameter)	Plate (Length x Width)	Finish	Wt. lbs.	Qty.
#50553	12-1/2" x 5/8"	6-1/4" x 3"	Bare	1.75 lbs.	10

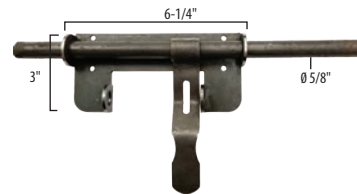

## Heavy-Duty Double Lockable Bar Gate Latch

Item #	Pin (Length x Diameter)	Plate (Length x Width)	Finish	Wt. lbs.	Qty.
#49683	9-1/2" x 3/4"	6-1/2" x 3-5/8"	Powder	2.35 lbs.	10



## Lockable Bar Gate Latches

Item #	Size	Pin (Length x Diameter)	Plate (Length x Width)	Finish	Wt. lbs.	Qty.
#49370	4"	6" x 1/2"	4" x 3"	Powder Coat	1.05 lbs.	10
#47750	5"	7-7/8" x 5/8"	5" x 3"	Powder Coat	1.48 lbs.	10
#47751	8"	13-1/4" x 3/4"	8" x 3"	Powder Coat	3.00 lbs.	10

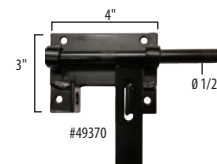

## Sliding Door Latch

Item #	Size (Length x Width)	Pin	Finish	Wt. lbs.	Qty.
#50462	9-3/4" x 5"	1/2"	Stainless Steel	1.30 lbs.	5

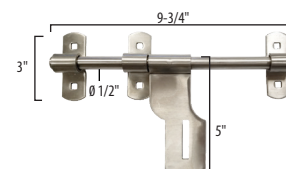



## 1/2" Slide Bolt Lockable Latch

Item #	Size (Length x Width x Height)	Pin	Finish	Wt. lbs.	Qty.
#49364	5-5/8" x 3" x 3"	1/2"	Bare	0.65 lbs.	10

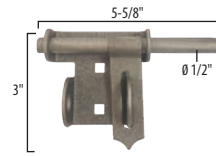

## 3-5/8" Gate Latch Kit

Item #	Size (Length x Width x Height)	Pin	Finish	Wt. lbs.	Qty.
#50299	3-5/8" x 3-5/8" x 3-1/2"	1/2"	Bare	0.88 lbs.	50

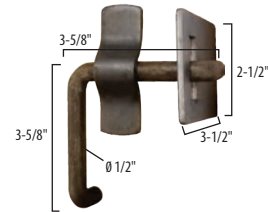

## Sliding Lockable Bolt

Item #	Size (Length x Width)	Pin	Finish	Wt. lbs.	Qty.
#49106	6-1/4" x 2-1/4"	3/4"	Stainless Steel	1.04 lbs.	10

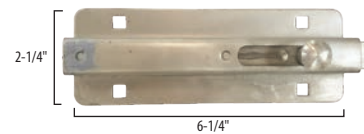

## Tower Bolt Door Latch

Item #	Size (Length x Width)	Pin	Finish	Wt. lbs.	Qty.
#50464	6" x 1-3/8"	3/8"	Stainless Steel	0.35 lbs.	25

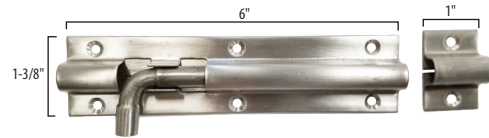

## Sliding Locking Latch

Item #	Size (Length x Width)	Pin	Finish	Wt. lbs.	Qty.
#50463	4-1/2" x 2-1/2"	3/8"	Stainless Steel	0.35 lbs.	25

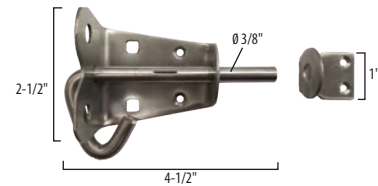

## Barrel Bolt Latches

Item #	Size (Length x Width)	Pin	Finish	Wt. lbs.	Qty.
#49427	3" x 1-5/8"	3/8"	Zinc	0.33 lbs.	10
#50418	6-1/2" x 1-1/2"	3/8"	Zinc	0.54 lbs.	70

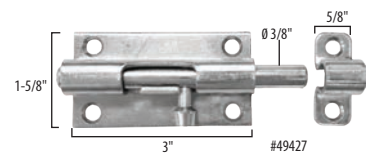

## Barrel Bolt Latch - Lockable

Item #	Size (Length x Width)	Pin	Finish	Wt. lbs.	Qty.
#50417	7" x 1-3/4"	3/8"	Zinc	0.74 lbs.	40

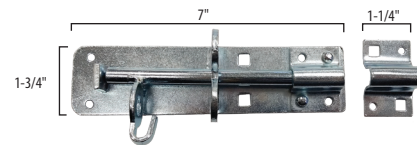

## Lockable Gate Slide Latch Kit

Item #	Size (Length x Width)	Pin	Finish	Wt. lbs.	Qty.
<i>New</i> #81589	2-1/2" x 3"	1/2"	Powder Coat	0.86 lbs.	40

\*Kit includes flat mount keeper and an angled mount keeper.

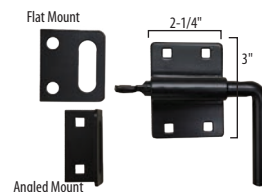

## Gate Drop Latch Kit

Item #	Size (Length x Width)	Pin	Finish	Wt. lbs.	Qty.
<i>New</i> #81565	3-1/2" x 2-1/8"	5/8"	Powder Coat	1.04 lbs.	35

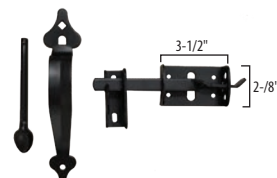

# HARDWARE LATCHES

## Toggle Clamps

Item #	Size	Finish	Handle	Wt. lbs.	Qty.
#48785	5"	Zinc	Red	0.51 lbs	10
#49921	5-1/2"	Stainless Steel	Black	0.52 lbs.	10
#48786	7"	Zinc	Red	1.46 lbs.	10

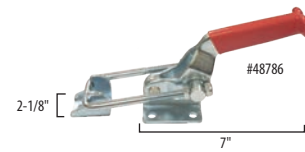

## Toggle Clamp With Release Clip

Item #	Size	Finish	Handle	Wt. lbs.	Qty.
<i>New</i> #81110	5"	Zinc	Red	0.57 lbs	60

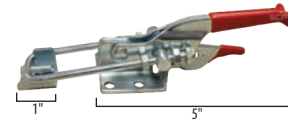

## Extra Heavy-Duty Draw Latch

Item #	Size	Finish	Handle	Wt. lbs.	Qty.
#80779	7"	Powder Coat	Yellow	7.04 lbs.	5

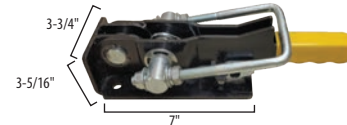

## Draw Latch - Heavy-Duty

Item #	Size	Finish	Clamp	Wt. lbs.	Qty.
<i>New</i> #81424	9"	HDG / Zinc	3/4"	2.09 lbs	1

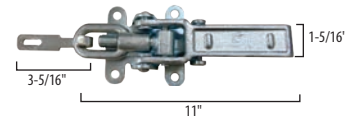

## Trailer Bar Latch Kit

Item #	Part	Finish	Wt. lbs.	Qty.
#50549	Kit	Bare	5.60 lbs.	1
#50571	Top Keeper	Bare	1.00 lbs.	25
#50572	Top Lug	Bare	0.55 lbs.	50
#50573	Top Pipe Holder, fits 1.05"	Bare	0.20 lbs.	50
#50574	Bottom Pipe Holder, fits 1.05"	Bare	0.20 lbs.	50
#50575	Handle	Bare	1.30 lbs.	25
#50576	Hasp for Handle	Bare	0.45 lbs.	50
#50577	Bottom Keeper	Bare	1.00 lbs.	25
#50578	Bottom Lug	Bare	0.55 lbs.	50



Trailer Lights

Lashing Rings



*Looking for additional trailer accessories?  
Check out the Trailer Parts  
section on pages 57 - 65.*

Stake pockets



Hitches

## Gate Hook Latch

Item #	Size (Length x Width)	Pin	Finish	Wt. lbs.	Qty.
#50466	6" x 1-1/2"	1/4"	Stainless Steel	0.10 lbs.	25

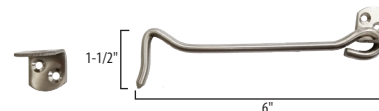

## Gate Hook Latch

Item #	Size (Length x Width)	Pin	Finish	Wt. lbs.	Qty.
<i>New</i> #81570	7" x 1-3/4"	3/8"	Powder Coat	0.04 lbs.	200



## Gate Snap With 30" Chain

Item #	Finish	Wt. lbs.	Qty.
#80440	Zinc	0.39 lbs.	20





## Heavy-Duty Gravity Gate Latch

Item #	Size (Length x Width x Depth)	Finish	Wt. lbs.	Qty.
<i>New</i> #81566	6-3/4" x 2-3/4" x 2-7/8"	Powder Coat	1.28 lbs.	32



## Gravity Gate Latches

Item #	Type	Size	Finish	Wt. lbs.	Qty.
#47820	(A) Bolt On	2"	Zinc	0.45 lbs.	1
#48526	(B) Bolt On	2"	Powder	0.45 lbs.	50
#48595	(C) Weld On	2"	Zinc	0.35 lbs.	50
#48631	(D) Bolt On	2"	Zinc	0.48 lbs.	50
#49737	(E) Weld On	1-3/4"	Bare	0.35 lbs.	10

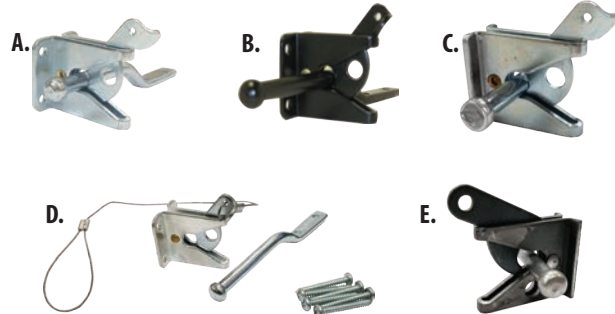

## Universal Gate Latch

Item #	Type	Finish	Wt. lbs.	Qty.
#48206	Latch	Powder	1.60 lbs.	20
#48208	Complete Set	Powder	4.89 lbs.	8

\*Hinges on page 20, handle on page 43

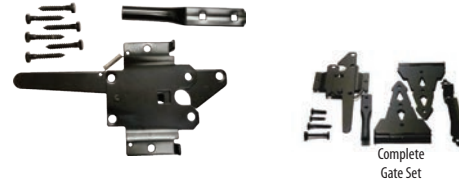

## Wood Post Lockable Gate Latches

Item #	Size (Length x Width x Depth)	Finish	Wt. lbs.	Qty.
#80271	21-1/2" x 6-1/8" x 2"	Powder	5.22 lbs.	5
#80272	21-1/2" x 6-1/8" x 2"	Powder	5.22 lbs.	140 <i>*Bulk Item</i>



## Cowboy Latch

Item #	Mounting Plate (Length x Width)	Pin	Finish	Wt. lbs.	Qty.
#50639	26" x 4"	1"	Bare	20.0 lbs.	1

This item does not qualify for free freight.

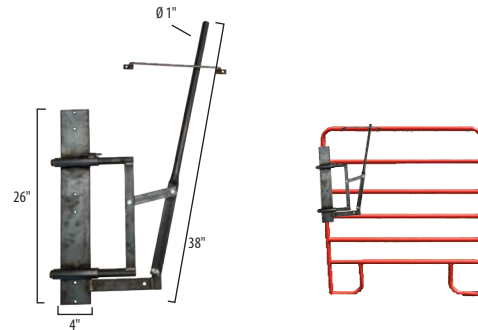

## Two-Way Lockable Kennel Latch

Item #	Size (Height x Width x Depth)	Finish	Wt. lbs.	Qty.
#50225	5-1/4" x 2-1/8" x 1-1/4"	Zinc	1.00 lbs.	10

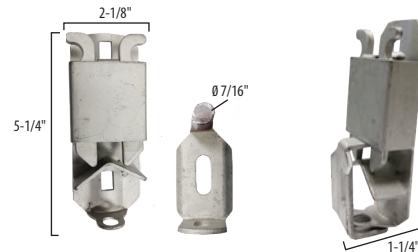

## Two-Way Lockable Livestock Gate Latch

Item #	Size (Length x Width x Depth)	Finish	Wt. lbs.	Qty.
#47711	8-7/16" x 4-1/4" x 1-11/16"	Zinc	5.16 lbs.	6



## Latch Keepers

Item #	Size (Length x Width x Height)	Pin Opening	Finish	Wt. lbs.	Qty.
#80124	2-1/8" x 3/4" x 5/8"	1/2"	Bare	0.03 lbs.	100
#80125	2-5/8" x 7/8" x 7/8"	5/8"	Bare	0.09 lbs.	100
#49478	2-5/8" x 5/8" x 1"	3/4"	Bare	0.06 lbs.	20
#80126	3" x 1" x 1"	3/4"	Bare	0.13 lbs.	100
#80127	4-1/8" x 1-1/4" x 1-1/8"	1"	Bare	0.24 lbs.	100

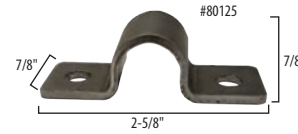

## Latch Keepers

Item #	Size (Depth x Height X Width)	Pin Opening	Finish	Wt. lbs.	Qty.
#50392	1-1/4" x 1-3/4" x 1-3/4"	1/2"	Zinc	0.20 lbs.	50
#50393	1-3/8" x 2-3/16" x 2-1/8"	3/4"	Zinc	0.35 lbs.	50
<i>New</i> #81063	1-1/2" x 2-1/2" x 2-11/16"	1-7/8" x 9/16"	Zinc	0.39 lbs.	50

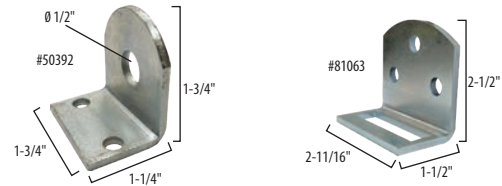

## Gate Striker Plates

Item #	Size (Length x Width x Depth)	Finish	Wt. lbs.	Qty.
#49829	1-3/4" x 2-1/2" x 2-5/8"	Zinc	0.39 lbs.	50
#47695	2-1/4" x 4-3/8" x 4-1/4"	Bare	1.40 lbs.	20
#47696	2-1/4" x 4-3/8" x 4-1/4"	Zinc	1.40 lbs.	20
#49830	2-1/4" x 4-3/8" x 4"	Bare	1.40 lbs.	20
<i>New</i> #81082	2-1/4" x 4-1/2" x 4-1/4"	Bare	1.48 lbs.	20



## Sign Up To Order Online!

It's simple and easy! Place orders, view product information, prices, and invoices.

Contact your sales representative for more information at 866-651-6702

Check out our website: [www.springcreekproducts.com](http://www.springcreekproducts.com)

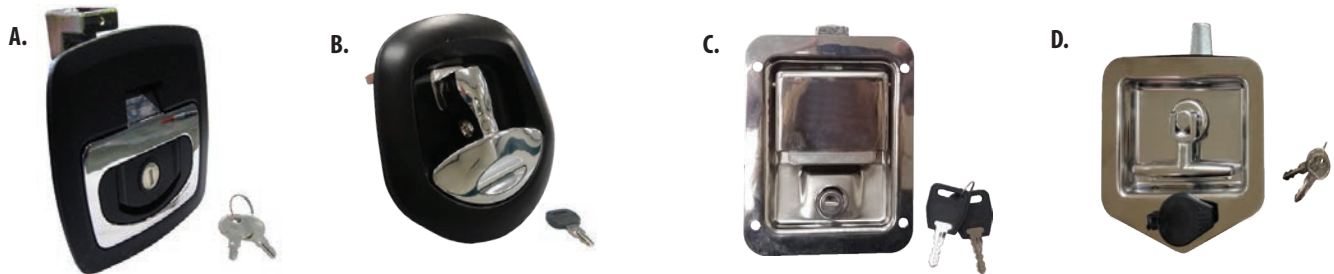
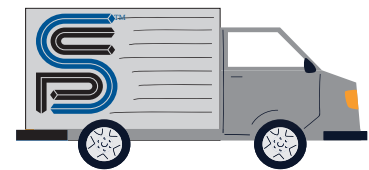

## Assorted Lockable Latches

Item #	Type	Latch Style	Plate Size (Width x Height x Depth)	Finish	Wt. lbs.	Qty.
#48145	(A) Compression Latch	Square Press and Pull	3-7/8" x 3-7/8" x 2-5/16"	Plastic	1.20 lbs.	1
#50141	(B) Whale Tail Latch	Whale Tail Lift and Turn	5-1/2" x 5-1/2" x 2-13/16"	Plastic	2.63 lbs.	10
#49429	(C) Slam Action Paddle Handle Latch	Square Studs	4-1/4" x 5-1/2" x 2-5/16"	Stainless Steel	1.01 lbs.	3
#49430	(D) Recessed Folding T-Handle Latch	Whale Tail Lift and Turn	4-3/4" x 4-7/8" x 2-7/8"	Stainless Steel	1.14 lbs.	1



## Piano Hinges

Item #	Size (Width x Length)	Thickness	Pin	Finish	Wt. lbs.	Qty.
#80178	2" x 72"	16ga	1/8"	Aluminum	0.85 lbs.	1
#80093	2" x 96"			Aluminum	1.13 lbs.	1
#80096	3" x 72"		3/16"	Aluminum	1.62 lbs.	1
#80090	1-1/2" x 72"	16ga	1/8"	Bare	2.00 lbs.	1
#80092	2" x 72"			Bare	2.50 lbs.	1
#80095	3" x 72"		3/16"	Bare	3.00 lbs.	1
#48115	2" x 72"	14ga	1/4"	Bare	4.00 lbs.	1
#48116	2-1/2" x 72"			Bare	4.50 lbs.	1
#48117	3" x 72"			Bare	6.40 lbs.	1
#80097	4" x 72"			Bare	7.00 lbs.	1
#80351	3" x 72"			13ga	Bare	6.40 lbs.
#49802	3" x 72"	11ga	3/8"	Bare	11.73 lbs.	1
#49803	4" x 72"			Bare	14.20 lbs.	1
#80091	1-1/2" x 72"	16ga	1/8"	Stainless Steel	2.47 lbs.	1
#80094	2" x 72"		3/16"	Stainless Steel	3.56 lbs.	1
#80098	3" x 72"	14ga	1/4"	Stainless Steel	5.00 lbs.	1

These items do not qualify for free freight.



## Flat Hinges

Item #	Size (Length x Width)	Thickness	Pin Size	Finish	Wt. lbs.	Qty.
#47052	2" x 2"	13ga	3/16"	Bare	0.13 lbs.	20
#47057	3-1/2" x 2-1/4"	12ga	3/16"	Bare	0.31 lbs.	20
#47053	3" x 3"	12ga	3/16"	Bare	0.33 lbs.	20
#50085	3" x 3"	14ga	3/16"	Bare	0.28 lbs.	20
#47054	3-1/2" x 3-1/2"	13ga	3/16"	Bare	0.38 lbs.	20
#47055	4" x 4"	13ga	3/16"	Bare	0.48 lbs.	40
#47056	3" x 3"	11ga	9/32"	Bare	0.44 lbs.	20
#47058	4" x 4"	7ga	5/16"	Bare	1.04 lbs.	20
#47135	5" x 5"	7ga	5/16"	Bare	1.57 lbs.	20
#47059	6" x 6"	7ga	5/16"	Bare	2.24 lbs.	10



## Flat Hinge - Bolt On

Item #	Size (Length x Width)	Thickness	Finish	Wt. lbs.	Qty
#50468	4" x 2-1/4"	16ga	Stainless Steel	0.20 lbs.	25

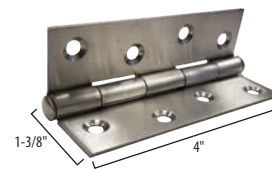

## Parliament Hinge - Bolt On

Item #	Size (Length x Width)	Thickness	Finish	Wt. lbs.	Qty
#50467	4" x 5-7/8"	12ga	Stainless Steel	0.65 lbs.	25



## Table Leg Braces (Left and Right)

Item #	Extended Length	Finish	Wt. lbs.	Qty.
#50018	16-3/4"	Stainless Steel	2.99 lbs.	10
#50168	16-3/4"	Zinc	2.99 lbs.	10

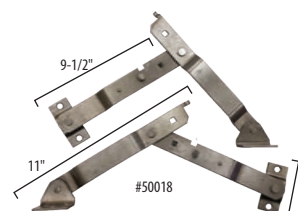

## Bullet Hinges

### Aluminum Body - Stainless Steel Pin And Bushing - With Grease Zerk

Item #	Size	Length	Thickness	Diameter	Pin Size	Wt. lbs.	Qty.
#50200	3-3/16"	3-3/16"	5/8"	1/2"	5/16"	0.08 lbs.	25
#50201	4"	4"	3/4"	5/8"	3/8"	0.18 lbs.	25
#50202	5-3/8"	5-3/8"	7/8"	3/4"	1/2"	0.31 lbs.	25
#80280	6"	6"	1"	7/8"	1/2"	0.38 lbs.	25
#50203	7"	7-1/16"	1"	3/4"	1/2"	0.48 lbs.	25

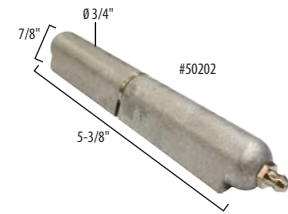

### Aluminum Body - Stainless Steel Pin And Bushing - No Grease Zerk

Item #	Size	Length	Thickness	Diameter	Pin Size	Wt. lbs.	Qty.
#49407	2"	2"	3/8"	5/16"	3/16"	0.02 lbs.	25
#49408	3-3/16"	3-3/16"	5/8"	1/2"	5/16"	0.08 lbs.	25
#49409	4"	4"	3/4"	5/8"	3/8"	0.18 lbs.	25
#49410	5-3/8"	5-3/8"	7/8"	3/8"	1/2"	0.48 lbs.	25
#80281	6"	6"	1"	7/8"	1/2"	0.43 lbs.	25
#49411	7"	7"	7/8"	3/4"	1/2"	0.48 lbs.	25

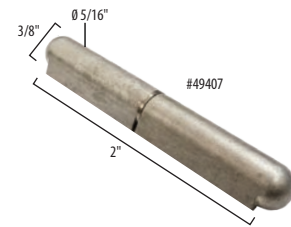

### Stainless Steel Body, Pin, And Bushing - No Grease Zerk

Item #	Size	Length	Thickness	Diameter	Pin Size	Wt. lbs.	Qty.
#49413	1-5/8"	1-5/8"	3/8"	5/16"	3/16"	0.03 lbs.	25
#49414	2"	2"	3/8"	5/16"	3/16"	0.04 lbs.	25
#49415	3-3/16"	3-3/16"	5/8"	1/2"	5/16"	0.18 lbs.	25
#49416	4"	4"	3/4"	5/8"	3/8"	0.35 lbs.	25
#49417	5-3/8"	5-3/8"	7/8"	3/4"	1/2"	0.63 lbs.	25
#49418	7"	7"	1"	3/4"	1/2"	1.04 lbs.	25

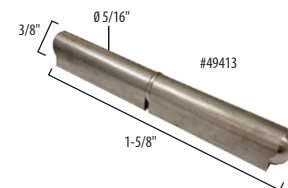

### Steel Body - Brass Pin And Bushing - With Grease Zerk

Item #	Size	Length	Thickness	Diameter	Pin Size	Wt. lbs.	Qty.
#80061	3"	3-1/8"	5/8"	1/2"	5/16"	0.20 lbs.	25
#80062	4"	3-7/8"	3/4"	5/8"	3/8"	0.35 lbs.	25
#80063	4-3/4"	4-3/4"	3/4"	5/8"	3/8"	0.45 lbs.	25
#80064	6"	5-7/8"	1"	3/4"	1/2"	0.75 lbs.	25
#80065	7"	7"	1"	3/4"	1/2"	1.00 lbs.	15

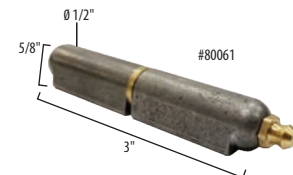

### Steel Body - Brass Pin And Bushing - No Grease Zerk

Item #	Size	Length	Thickness	Diameter	Pin Size	Wt. lbs.	Qty.
#48713	2"	2"	3/8"	5/16"	3/16"	0.04 lbs.	25
#48217	3-3/16"	3-3/16"	5/8"	1/2"	5/16"	0.19 lbs.	25
#48218	4"	3-15/16"	3/4"	5/8"	3/8"	0.35 lbs.	25
#48219	4-3/4"	4-3/4"	3/4"	5/8"	3/8"	0.41 lbs.	25
#49752	6"	5-15/16"	1"	3/4"	1/2"	0.86 lbs.	25
#49167	7"	7"	1"	3/4"	1/2"	1.05 lbs.	25
#49751	8"	7-7/8"	1-1/8"	15/16"	5/8"	1.53 lbs.	20

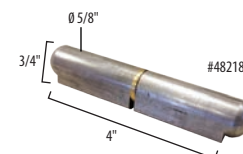

Item #	Size	Length	Thickness	Diameter	Pin Size	Wt. lbs.	Qty. (Pairs)
#70212	3-3/16"	3-3/16"	5/8"	1/2"	5/16"	0.38 lbs.	10
#70213	4"	3-15/16"	3/4"	5/8"	3/8"	0.70 lbs.	10

\*Pairs

\*Pairs



**Bullet Hinges**

**Steel Body And Pin - Brass Bushing - No Grease Zerk**

Item #	Size	Length	Thickness	Diameter	Pin Size	Wt. lbs.	Qty.
#50072	2"	1-15/16"	3/8"	5/16"	3/16"	0.04 lbs.	25
#50073	2-3/4"	2-3/4"	1/2"	7/16"	1/4"	0.12 lbs.	25
#50060	3-5/16"	3-1/8"	5/8"	1/2"	5/16"	0.18 lbs.	25
#50084	4"	3-15/16"	3/4"	5/8"	3/8"	0.35 lbs.	25
#50062	4-3/4"	4-3/4"	3/4"	5/8"	3/8"	0.40 lbs.	25
#50074	6"	5-15/16"	1"	3/4"	1/2"	0.80 lbs.	25
#50075	7"	7-1/16"	1"	3/4"	1/2"	0.97 lbs.	25
#50076	8"	7-7/8"	1-1/7"	7/8"	5/8"	1.44 lbs.	25

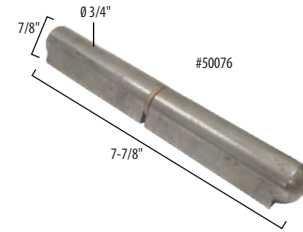

**Steel Body And Pin - Brass Bushing - With Grease Zerk**

Item #	Size	Length	Thickness	Diameter	Pin Size	Wt. lbs.	Qty.
#48220	3-3/16"	3-3/16"	5/8"	1/2"	5/16"	0.17 lbs.	25
#47019	4"	4"	3/4"	5/8"	3/8"	0.36 lbs.	25
#48236	4-3/4"	4-3/4"	3/4"	5/8"	3/8"	0.42 lbs.	25
#49753	6"	5-15/16"	1"	3/4"	1/2"	0.83 lbs.	25
#47638	7"	7"	1"	3/4"	1/2"	1.01 lbs.	25
#49754	8"	8-3/16"	1-1/8"	15/16"	5/8"	1.46 lbs.	25
#47639	10"	10"	1-1/2"	1-1/16"	3/4"	3.00 lbs.	10

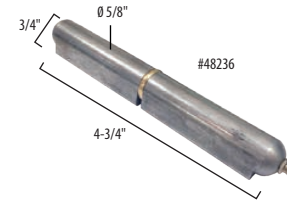

Item #	Size	Length	Thickness	Diameter	Pin Size	Wt. lbs.	Qty. (Pairs)
#70214	3-3/16"	3-3/16"	5/8"	1/2"	5/16"	0.38 lbs.	10 *Pairs
#70215	4"	4"	3/4"	5/8"	3/8"	0.72 lbs.	10 *Pairs
#70216	4-3/4"	4-3/4"	3/4"	5/8"	3/8"	1.18 lbs.	10 *Pairs



**Zinc Body, Pin, And Brass Bushing - With Grease Zerk**

Item #	Size	Length	Thickness	Diameter	Pin Size	Wt. lbs.	Qty.
#80711	7"	7"	1"	3/4"	1/2"	1.01 lbs.	25

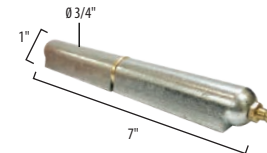

*If you need help with an order, have questions about our products, or have an inquiry about setting up an account, please contact a member of our team today!*

*We would love to hear from you!  
1-866-651-6702 or sales@springcreekproducts.com*

**Steel Body And Pin - Brass Bushing - No Grease Zerk - Lift Off**

Item #	Size (Length x Width)	Pin (Length x Diameter)	Wt. lbs.	Qty
#50297	3-1/8" x 7/8"	1-1/8" x 1/4"	0.19 lbs.	20

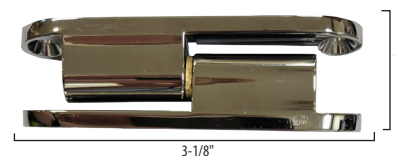



**Barrel Hinges**

**Steel Body And Pin - No Grease Zerk**

Item #	Size	Diameter	Pin Size	Wt. lbs.	Qty.
#47811	2"	5/8"	3/8"	0.16 lbs.	48
#47722	3"	3/4"	1"	0.36 lbs.	25

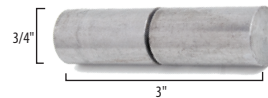

Item #	Size	Diameter	Pin Size	Wt. lbs.	Qty. (Pairs)
#70217	3"	3/4"	1"	0.76 lbs.	10 *Pairs



**Zinc Body And Pin - With Grease Zerk**

Item #	Size (Length x Width)	Pin Size	Wt. lbs.	Qty.
#47118	4-3/8" x 3/4"	1/2"	0.51 lbs.	20



**Round Hinge - Steel Body And Pin - Brass Bushing - With Grease Zerk**

Item #	Size	Length	Diameter	Pin Size	Wt. lbs.	Qty.
#47645	4"	3-15/16"	5/8"	3/8"	0.33 lbs.	20
#47646	6"	5-15/16"	3/4"	1/2"	0.78 lbs.	20
#47647	10"	10-1/4"	1-1/8"	3/4"	2.70 lbs.	8



**Barrel Hinges With Sleeve**

Item #	Size (Length x Diameter)	Pin Size (Length x Diameter)	Finish	Wt. lbs.	Qty.
#80029	3-15/16" x 3/4"	1-7/8" x 1/2"	Bare	0.45 lbs.	25
#50179	4" x 1"	2" x 3/4"	Bare	0.83 lbs.	25
#50180	4-3/4" x 1"	2-5/8" x 3/4"	Bare	0.91 lbs.	25 *
#50181	5-3/8" x 3/4"	3-1/4" x 1/2"	Bare	0.91 lbs.	25 *



\*Includes snap ring feature

**Steel Snap Rings**

Item #	Diameter	Wt. lbs.	Finish	Fits	Qty.
#50293	3/4"	0.01 lbs.	Bare	4-3/4"	500
#50586	3/4"	0.01 lbs.	Bare	5-3/4"	1,000



**10" Round Hinge - Three Piece**

Item #	Size (O.D. x Length)	Finish	Wt. lbs.	Qty
#50153	1" x 10-1/8"	Bare	2.07 lbs.	10

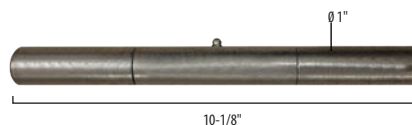

**Three Piece Gate Hinge**

Item #	Outer Pipe (O.D. x Length)	Inner Rod (Diameter x Length)	Finish	Wt. lbs.	Qty
#50068	1.05" x 3-1/16"	3/4" x 6"	Bare	1.33 lbs.	20

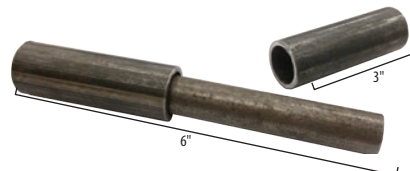

**Steel Body Barrel Hinge**

Item #	Size (O.D. x Length)	Finish	Wt. lbs.	Qty
#80415	3/4" x 8-3/4"	Bare	1.34 lbs.	20



**Barrel Hinges With Grease Zerks And Weld Plates**

**Powder Coat**

Item #	Size	Length	Width	Height	Weld Plate	Pin Size	Wt. lbs.	Qty.
#49994	4"	4-7/8"	1"	1-3/8"	3/8"	1/2"	1.38 lbs.	10
#47050	5"	5-5/8"	1-1/2"	1-3/16"	1/4"	5/8"	1.44 lbs.	10
#49995	6"	6-3/4"	1-1/2"	1-3/4"	3/8"	7/8"	3.39 lbs.	6
#47051	7"	7-1/4"	1-1/2"	1-7/16"	1/4"	3/4"	2.74 lbs.	6
#80638	9"	9-3/4"	2"	2-3/8"	3/8"	1"	9.62 lbs.	1



**Powder Coat Pairs**

Item #	Size	Length	Width	Height	Weld Plate	Pin Size	Wt. lbs.	Qty.
#80721	4"	4-7/8"	1"	1-3/8"	3/8"	1/2"	2.81 lbs.	2
#80715	5"	5-5/8"	1-1/2"	1-3/16"	1/4"	5/8"	2.92 lbs.	2
#80722	6"	6-3/4"	1-1/2"	1-3/4"	3/8"	7/8"	7.93 lbs.	2
#80716	7"	7-1/4"	1-1/2"	1-7/16"	1/4"	3/4"	5.61 lbs.	2



**Zinc Plated**

Item #	Size	Length	Width	Height	Weld Plate	Pin Size	Wt. lbs.	Qty.
#80706	4"	4-7/8"	1"	1-3/8"	3/8"	1/2"	1.36 lbs.	10
#80709	5"	5-5/8"	1-1/2"	1-3/16"	1/4"	5/8"	1.43 lbs.	10
#80708	6"	6-3/4"	1-1/2"	1-3/4"	3/8"	7/8"	3.40 lbs.	6
#80710	7"	7-1/4"	1-1/2"	1-7/16"	1/4"	3/4"	2.76 lbs.	6

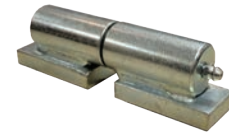

**Round Hinge - Steel Body And Pin - Brass Bushing - With Grease Zerk And Weld Plate**

Item #	Size	Length	Width	Diameter	Weld Plate	Pin Size	Wt. lbs.	Qty.
#47640	4"	4-5/16"	3/4"	5/8"	3/16"	3/8"	0.50 lbs.	30
#47641	6"	6-7/16"	1"	3/4"	1/4"	1/2"	1.16 lbs.	20
#47642	10"	10-5/8"	1-1/4"	1-1/8"	3/16"	3/4"	3.58 lbs.	6



**Square Hinges**

**Bare**

Item #	Size	Size (Length x Width x Height)	Pin	Wt. lbs.	Qty.
#47088	5"	5" x 1-1/4" x 1"	5/8"	1.64 lbs.	10
#47089	7"	6-3/4" x 1-3/4" x 1-1/4"	3/4"	3.92 lbs.	6



**Bare - Pairs**

Item #	Size	Size (Length x Width x Height)	Pin	Wt. lbs.	Qty.
#80717	5"	5" x 1-1/4" x 1"	5/8"	3.35 lbs.	2
#80718	7"	6-3/4" x 1-3/4" x 1-1/4"	3/4"	7.96 lbs.	2



**Zinc**

Item #	Size	Size (Length x Width x Height)	Pin	Wt. lbs.	Qty.
#80705	5"	5" x 1-1/4" x 1"	5/8"	1.66 lbs.	10
#80707	7"	6-3/4" x 1-3/4" x 1-1/4"	3/4"	3.94 lbs.	6

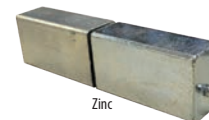

**Clamshell**

Item #	Size	Size (Length x Width x Height)	Pin	Finish	Wt. lbs.	Qty.
#70218	5"	5" x 1-1/4" x 1"	5/8"	Bare	1.74 lbs.	10



## Dump Trailer Hinge With Grease Zerk

Item #	Size (Length x Width)	Plate Thickness	Finish	Wt. lbs.	Qty.
#80251	7-1/2" x 4-1/4"	3/8"	Bare	3.38 lbs.	10

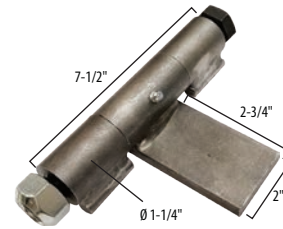

## Formed Hinge Straps

Item #	Size (Length x Width)	Leaf Length	Style	Finish	Wt. lbs.	Qty.
#50128	4-1/4" x 2-1/4"	1"	Left	Bare	2.14 lbs.	10
#80770	4-1/4" x 2-1/4"	1"	Right	Bare	2.14 lbs.	10
#50292	6-1/8" x 2-1/4"	3"	Right	Bare	2.55 lbs.	10



## Flag Double Wrap Hinge

Item #	Size (Length x Width)	Pin	Finish	Wt. lbs.	Qty.
#47676	4" x 2-3/4"	1/2"	Bare	0.69 lbs.	20

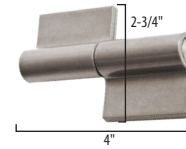

## Flag Double Wrap Hinge - Bolt On

Item #	Size (Length x Width)	Finish	Wt. lbs.	Qty.
#80236	4" x 2-1/2"	Powder Coat	0.53 lbs.	20

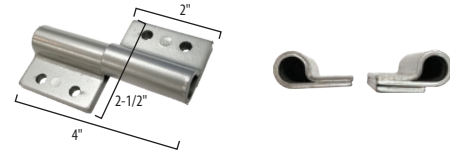

## Bat Wing Hinges

Item #	Type	Size (Length x Width x Height)	Pin (Diameter x Length)	Finish	Wt. lbs.	Qty.
#47768	Female	1-1/8" x 1" x 1-1/2"	1/2"	Bare	0.10 lbs.	20
#47769	Male	1" x 1" x 1-1/2"	1/2" x 1"	Bare	0.17 lbs.	10
#47856	Female	1-1/4" x 1-3/16" x 1-5/8"	5/8"	Bare	0.19 lbs.	10
#47857	Male	1-1/4" x 1-3/16" x 1-5/8"	5/8" x 1"	Bare	0.22 lbs.	10
#47869	Female	1-1/4" x 1-1/4" x 1-5/8"	3/4"	Bare	0.13 lbs.	10
#47870	Male	1-1/4" x 1-1/4" x 1-5/8"	3/4" x 1"	Bare	0.27 lbs.	10

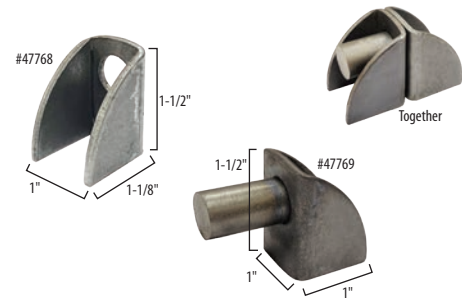

## Bat Wing Hinge With Weld Tab

Item #	Weld Tab (Length x Width)	Thickness	Finish	Wt. lbs.	Qty.
#50554	3-7/8" x 1-1/2"	9ga	Bare	0.35 lbs.	10

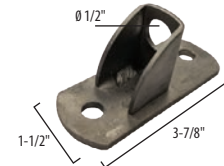

## Winged Hinges

Item #	Size	Size (Length x Width)	Wing Length	Pin	Finish	Wt. lbs.	Qty.
#47643	3-1/2"	3-5/8" x 1-7/8"	1-9/16"	3/4"	Bare	1.06 lbs.	20
#47644	7"	7-1/8" x 1-3/4"	3-3/8"	3/4"	Bare	2.15 lbs.	10





## M 18 Swivel Weld On Hinge With Nut

Item #	Size (Welding Surface)	Bolt (Length x Diameter)	Finish	Wt. lbs.	Qty.
#49130	1-3/16" x 1-7/16"	1-5/8" x 5/8"	Zinc	0.65 lbs.	20

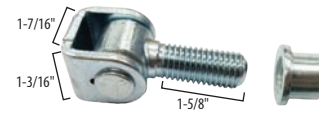

## 360 Degree Weld On Hinge

Item #	Size (Length x Diameter)	Finish	Wt. lbs.	Qty.
#80690	5-1/2" x 3/4"	Zinc	1.24 lbs.	7

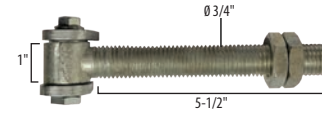

## Adjustable Square Hinges

Item #	Size	Size (Length x Width x Height)	Diameter	Finish	Wt. lbs.	Qty.
#80033	7"	5-1/2" x 1-1/4" x 9-3/8"	7/8"	Bare	4.95 lbs.	2
#80714	7"	5-1/2" x 1-1/4" x 9-3/8"	7/8"	Zinc	4.86 lbs.	2

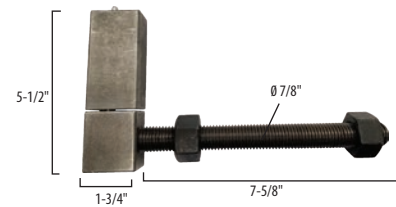

## Adjustable Square Hinge - With J-bolt

Item #	Size	Size (Length x Width x Height)	Diameter	Finish	Wt. lbs.	Qty.
#80032	4"	5-3/8" x 3-5/8" x 1"	5/8"	Zinc	2.75 lbs.	2

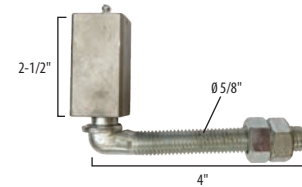

## J-Bolt Adjustable Barrel Hinges

### Powder Coat

Item #	Diameter	Length	Height	Plate Size (Length x Width)	Wt. lbs.	Qty.
#48036	5/8"	5-5/16"	3-3/4"	2-1/8" x 1"	1.30 lbs.	20
#48037	3/4"	10"	4-3/4"	2-7/8" x 1-1/2"	3.00 lbs.	8



### Powder Coat Pairs

Item #	Diameter	Length	Height	Plate Size (Length x Width)	Wt. lbs.	Qty.
#80719	5/8"	5-5/16"	3-3/4"	2-1/8" x 1"	2.69 lbs.	2
#80720	3/4"	10"	4-3/4"	2-7/8" x 1-1/2"	6.36 lbs.	2



### Zinc Plated

Item #	Diameter	Length	Height	Plate Size (Length x Width)	Wt. lbs.	Qty.
#80712	5/8"	5-5/16"	3-3/4"	2-1/8" x 1"	1.29 lbs.	20
#80713	3/4"	10"	4-3/4"	2-7/8" x 1-1/2"	3.10 lbs.	8



## Adjustable Hinge - Bolt On

Item #	Size (Length x Width)	Finish	Wt. lbs.	Qty.
#80691	4" x 3-3/8"	Zinc	1.64 lbs.	10

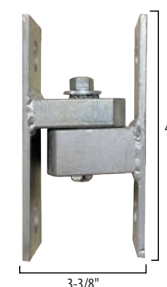

**Tear Drop Hinge Plate**

Item #	Size (Length x Width)	Hole Size	Thickness	Finish	Wt. lbs.	Qty.
#48072	4" x 1-5/8"	5/8"	3/8"	Bare	0.43 lbs.	66



**Tear Drop Hinges With Notch**

Item #	Size (Length X Width)	Hole Size	Thickness	Finish	Wt. lbs.	Qty.
#50086	2-1/8" x 1"	3/8"	1/4"	Bare	0.10 lbs.	200
#50087	6-1/16" x 2-3/8"	3/4"	3/8"	Bare	0.90 lbs.	25



**\$1,000+ Orders Ship For Free!!!!**



**Call your sales representative  
today to see if you qualify!  
1-866-651-6702**

*Some exclusions apply, offer subject to change without notice.*

**Heavy-Duty Gate Hinges - Gate To Post Mount**

Item #	Type	Plate Size (Length x Width x Thickness)	Finish	Wt. lbs.	Qty.
#48371	Standard	7" x 2-7/8" x 1/4"	Powder Coat	3.75 lbs.	2
#80279	Adjustable	7-7/8" x 1-3/4" x 1/4"	Powder Coat	4.52 lbs.	2

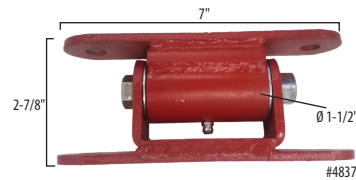

**Heavy-Duty Gate Hinges - Flat Mount**

Item #	Type	Plate Size (Length x Width x Thickness)	Finish	Wt. lbs.	Qty.
#48372	Standard	5" x 2" x 4ga	Powder Coat	5.48 lbs.	2
#80250	Mini	3-1/2" x 1-1/2" x 4ga	Powder Coat	2.44 lbs.	2
#80277	Adjustable	3-1/2" x 1-3/4" x 1/4"	Powder Coat	2.79 lbs.	2



**Heavy-Duty Gate Hinges - Round Mount**

Item #	Type	Plate Size (Length x Width)	Finish	Wt. lbs.	Qty.
#48373	Standard	3-3/8" x 1-1/2"	Powder Coat	5.42 lbs.	2
#80278	Adjustable	2-7/8" x 1-1/2"	Powder Coat	2.92 lbs.	2

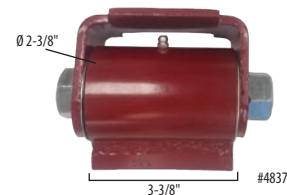

**Heavy-Duty Gate Hinge - Flat Mount**

Item #	Plate Size (Length x Width x Thickness)	Finish	Wt. lbs.	Qty.
#48374	3-1/2" x 1-1/2" x 4ga	Powder Coat	2.45 lbs.	2



## Compression Spring

Item #	Size (Height x Width)	Thickness	Finish	Wt. lbs.	Qty.
<i>New</i> #81085	3/4" x 1-3/4"	1/8"	Zinc	0.04 lbs.	500

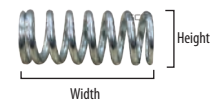

## Tension Spring 7"

Item #	Size (Length x Diameter)	Finish	Wt. lbs.	Qty.
#80984	7" x 1"	Zinc	0.40 lbs.	100

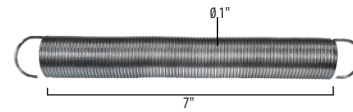

## Spring Connector

Item #	Spring Size (Length x Diameter)	Finish	Wt. lbs.	Qty.
#50061	3-3/16" x 1/2"	Zinc	0.09 lbs.	50

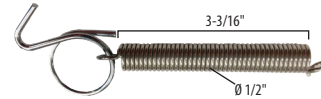

## Spring Closers

Item #	Size	Finish	Wt. lbs.	Qty.
#49848	9"	Powder Coat	1.15 lbs.	10
#49768	12"	Powder Coat	1.18 lbs.	10

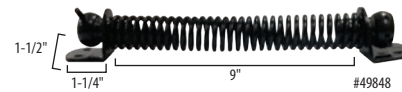

## Chute Springs

Item #	Style	Finish	Wt. lbs.	Qty.
#49786	Left	Bare	0.05 lbs.	1
#49787	Right	Bare	0.05 lbs.	1



## Chute Springs

Item #	Size (Length x Diameter)	Finish	Wt. lbs.	Qty.
#50136	(A) 12" x 1"	Bare	0.65 lbs.	1
#50137	(B) 4-3/8" x 3/4"	Bare	0.06 lbs.	1



## Cable Springs

Item #	Size (Thickness x OD x Length)	Finish	Wt. lbs.	Qty.
#80104	5/16" x 1-3/4" 11-1/2"	Painted	3.00 lbs.	10 / box
#47959				200 / drum



## Cable Spring - Closed Loop

Item #	Size (Thickness x OD x Length)	Finish	Wt. lbs.	Qty.
#80230	1/4" x 1-1/2" 11"	Bare	2.60 lbs.	10

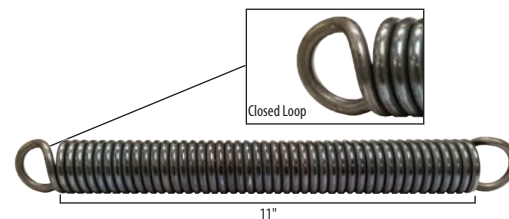

## Cable Grips

Item #	Size	Length	Finish	Wt. lbs.	Qty.
#48457	1/4"	20-5/8"	Galvanized	0.32 lbs.	50
#46488	5/16"	22-1/4"	Galvanized	0.56 lbs.	50
#46640	3/8"	31"	Galvanized	1.06 lbs.	50
#46489	7/16"	35"	Galvanized	1.70 lbs.	25
#46641	1/2"	40"	Galvanized	2.40 lbs.	25

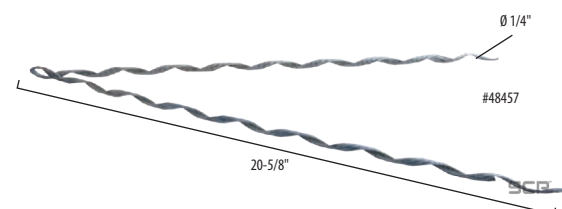



# HARDWARE PIPE HINGES

## Pipe Hinges - 1 Sleeve / 2 Collars

Item #	Size (Fits over)	O.D. (A)	Sleeve Ht. (B)	Collar Ht. (C)	Finish	Wt. lbs.	Qty.
#49998	1.25" O.D.	1-3/4"	4"	7/16" ea.	Bare	1.60 lbs.	10
#80986	1.315" O.D.	1-3/4"	3-1/4"	7/16" ea.	Bare	1.07 lbs.	20
#49999	1.66" O.D.	2-1/4"	4"	7/16" ea.	Bare	1.75 lbs.	10
#49654	1.90" O.D.	2-3/8"	3"	1" ea.	Bare	1.90 lbs.	10
#50192	1.90" O.D.	2-3/8"	3"	1" ea.	Zinc	1.90 lbs.	10
#49655	2.375" O.D.	2-7/8"	3"	1" ea.	Bare	2.56 lbs.	10
#49656	2.875" O.D.	3-1/2"	3"	1" ea.	Bare	3.70 lbs.	10
#80195	3.50" O.D.	4"	6"	1" ea.	Bare	5.25 lbs.	4
#80196	4.50" O.D.	5"	8"	1-1/4" ea.	Bare	9.56 lbs.	4
<i>New</i> #80197	6.625" O.D.	7-1/16"	10-1/16"	1-1/2"	Bare	16.24 lbs.	2



## Pipe Hinges - 2 Sleeves / 1 Collar

Item #	Size (Fits over)	O.D. (A)	Sleeve Ht. (B)	Collar Ht. (C)	Finish	Wt. lbs.	Qty.
#80101 #50272	1.66" O.D.	2-1/4"	4"	1/2"	Bare	3.50 lbs.	10 / box 300 / crate
#80102 #50042	1.90" O.D.	2-3/8"	3-1/2"	1"	Bare	3.04 lbs.	10 / box 150 / crate
#80103 #50145	2.375" O.D.	2-7/8"	4"	1"	Bare	4.61 lbs.	10 / box 150 / crate



## Pipe Hinges - 1 Sleeve / 1 Collar

Item #	Size (Fits over)	O.D. (A)	Sleeve Ht. (B)	Collar Ht. (C)	Finish	Wt. lbs.	Qty.
<i>New</i> #80206	1.25" O.D.	1-3/4"	4"	7/16"	Bare	1.36 lbs.	20
#80078	1.315" O.D.	1-3/4"	3-1/4"	1/2"	Bare	0.96 lbs.	20
#80015	1.66" O.D.	2-1/4"	4"	1/2"	Bare	2.04 lbs.	20



*Looking for additional gate accessories?  
Check out the gate latch section  
on pages 1 - 6 and the chain keeper  
section on page 26.*



## Pipe Hinges With Threaded Rod

Item #	Size (Fits Over)	Sleeve Height	Thread (Length x Diameter)	Finish	Wt. lbs.	Qty.
#50321	2" O.D.	3"	10-1/2" x 3/4"	Zinc	2.70 lbs.	10
#80977	2-1/16" OD	2"	10-1/2" x 3/4"	Zinc	2.43 lbs.	10

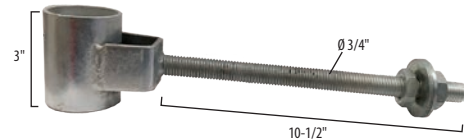

## Heavy Pipe Hinges With Threaded Rod

Item #	Size (Fits Over)	Sleeve Ht.	Collar Ht.	Thread (Length x Diameter)	Finish	Wt. lbs.	Qty.
#80119	1.66" O.D.	4"	1"	14" x 1"	Bare	9.30 lbs.	4
#80121	1.90" O.D.	4"	1"	14" x 1"	Bare	9.60 lbs.	4
#81047	3-1/2" O.D.	6"	1"	14-3/4" x 1"	Bare	9.75 lbs.	2
#81048	4-1/2" O.D.	8"	1-1/4"	17-1/4" x 1"	Bare	14.48 lbs.	2

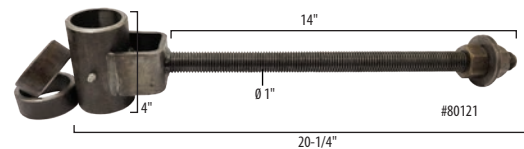

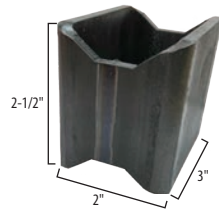

## Rectangular Hinge Adapter

Item #	Size (Length x Width x Height)	Thickness	Finish	Wt. lbs.	Qty.
#80424	2" x 3" x 2-1/2"	3/16"	Bare	1.10 lbs.	36



Round Mount to  
Flat Mount



Round Mount to  
Round Mount



## Ring Adapter for Pipe

### Ring Adapters For Pipe

Item #	Holds (Fits Over)	Size (Height x Width)	Thickness	Finish	Wt. lbs.	Qty.
#80425	1.25" OD	2-1/2" x 1-3/4"	3/8"	Bare	0.29 lbs.	20
#80427	1.66" OD	3" x 2-1/4"	3/8"	Bare	0.43 lbs.	20
#80429	1.90" OD	3-1/16" x 2-3/8"	3/8"	Bare	0.39 lbs.	20
#80431	2.375" OD	3-5/8" x 2-7/8"	3/8"	Bare	0.52 lbs.	20
#80433	2.875" OD	4-1/4" x 3-7/16"	3/8"	Bare	0.68 lbs.	20
#80435	3.50" OD	4-11/16" x 4"	3/8"	Bare	0.74 lbs.	20
#80437	4.50" OD	5-3/4" x 5"	3/8"	Bare	1.04 lbs.	20

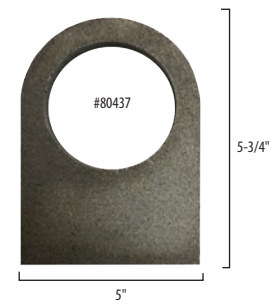

### Ring Adapters For Hinge Sleeves

Item #	Holds (Fits Over)	Size (Height x Width)	Hinge Sleeve Reference	Thickness	Finish	Wt. lbs.	Qty.
#80426	1.765" OD	2-3/4" x 2-1/4"	1.25" OD	3/8"	Bare	0.36 lbs.	20
#80428	2.25" OD	3-3/8" x 2-7/8"	1.66" OD	3/8"	Bare	0.47 lbs.	20
#80430	2.36" OD	3-3/8" x 2-7/8"	1.90" OD	3/8"	Bare	0.43 lbs.	20
#80432	2.875" OD	3-7/8" x 3-3/8"	2.375" OD	3/8"	Bare	0.54 lbs.	20
#80434	3.438" OD	4-11/16" x 4"	2.875" OD	3/8"	Bare	0.73 lbs.	20
#80436	3.967" OD	4-15/16" x 4-7/16"	3.50" OD	3/8"	Bare	0.77 lbs.	20
#80438	5.00" OD	6" x 5-1/2"	4.50" OD	3/8"	Bare	1.02 lbs.	20

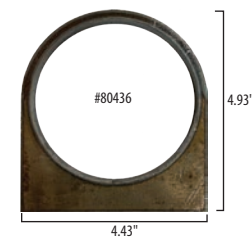

**Strap Hinge**

Item #	Size (Length x Width)	Finish	Wt. lbs.	Qty.
#50157	10" x 4-1/2"	HDG	1.65 lbs.	10

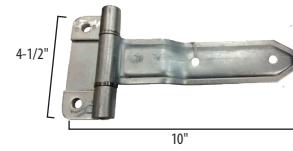

**Strap Hinges - Stainless Steel**

Item #	Type	Size (Length x Width)	Finish	Wt. lbs.	Qty.
#50154	(A) Weld On	6-1/8" x 2-5/8"	SS	0.59 lbs.	10
#50155	(B) Round-Bolt On	6-1/8" x 2-5/8"	SS	0.57 lbs.	10
#50156	(C) Square-Bolt On	6-1/8" x 2-5/8"	SS	0.58 lbs.	10

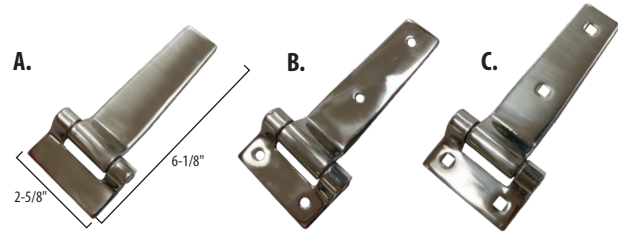

**Strap Hinges With Grease Zerk**

Item #	Size (Length x Width)	Thickness	Finish	Wt. lbs.	Qty.
#49460	5-3/4" x 2-1/2"	9ga	Zinc	0.66 lbs.	10
#49461	7-3/8" x 2-1/2"	9ga	Zinc	0.78 lbs.	25

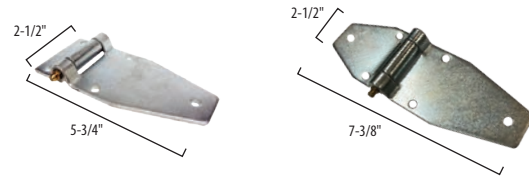

**Strap Hinges**

Item #	Size	Length x Height	Finish	Wt. lbs.	Qty.
#50308	4-1/4"	8" x 1-3/4"	Zinc	0.27 lbs.	100
#50309	5"-3/16"	10" x 2"	Zinc	0.36 lbs.	100
#50310	6-1/8"	11-1/2" x 2-1/2"	Zinc	0.53 lbs.	10

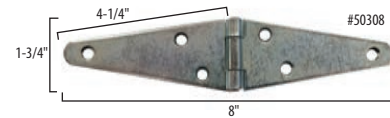

*Visit us at*  
[www.springcreekproducts.com](http://www.springcreekproducts.com)

**Strap Hinges With Triangle Base**

Item #	Size	Length x Height	Finish	Wt. lbs.	Qty.
#50311	8"	11" x 4-1/2"	Zinc	1.92 lbs.	10
#50312	12"	15" x 4-1/2"	Zinc	2.29 lbs.	10
#50313	16"	19" x 4-1/2"	Zinc	2.61 lbs.	10

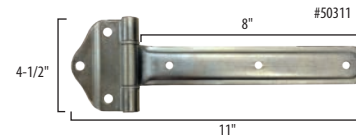

**Embossed Strap Hinges**

Item #	Size	Length x Height	Finish	Wt. lbs.	Qty.
#50066	10-1/4"	10-1/4" x 4-1/2"	Zinc	1.15 lbs.	10
#50065	17-3/4"	17-3/4" x 4-1/2"	Zinc	2.42 lbs.	10

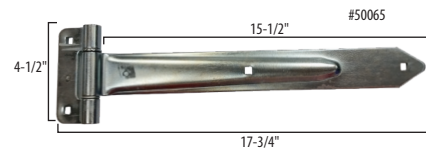

**Heavy-Duty Tee Hinge**

Item #	Size (Length x Width)	Finish	Wt. lbs.	Qty.
#50424	12-1/2" x 7"	Zinc	2.20 lbs.	20

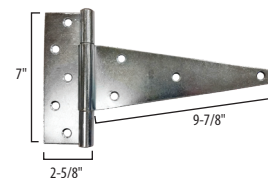



## Tee Hinge

Item #	Size (Length x Width)	Finish	Wt. lbs.	Qty.
<i>New</i> #81568	3-5/8" x 2-1/4"	Powder Coat	0.10 lbs.	34

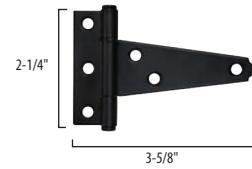

## Decorative Tee Hinge

Item #	Size (Length x Width)	Finish	Wt. lbs.	Qty.
<i>New</i> #81588	7-1/4" x 4-1/4"	Powder Coat	0.58 lbs.	60

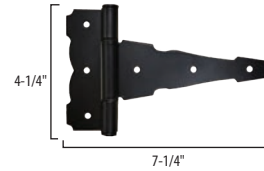

## Decorative Tee Hinge

Item #	Size (Length x Width)	Finish	Wt. lbs.	Qty.
<i>New</i> #81569	14-1/2" x 8-1/2"	Powder Coat	2.62 lbs.	15

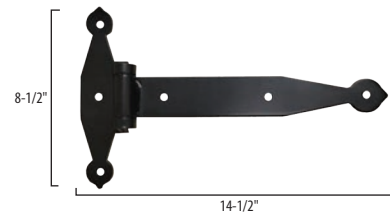

## Universal Strap Hinge

Item #	Type	Finish	Wt. lbs.	Qty.
#48207	8" Hinge	Powder Coat	1.51 lbs.	10
#48208	Complete Set	Powder Coat	5.87 lbs.	8

\*Latches on page 6, handle on page 43

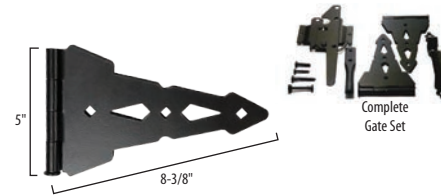

## Hasp And Staple

Item #	Staple (Length x Width)	Hasp (Length x Width)	Finish	Wt. lbs.	Qty
#50465	1-1/2" x 1-1/2"	4-3/8" x 1-3/8"	SS	0.20 lbs.	25



## Hasp And Staple Hinge Strap

Item #	Staple (Length x Width)	Hasp (Length x Width)	Finish	Wt. lbs.	Qty
#50298	1-7/8" x 2"	9-3/4" x 3/4"	Zinc	1.18 lbs.	50



## Hasp And Staple Hinge Strap

Item #	Staple (Length x Width)	Hasp (Length x Width)	Finish	Wt. lbs.	Qty
#50314	1-5/8" x 1-3/16"	6-1/4" x 1-1/2"	Zinc	0.27 lbs.	20

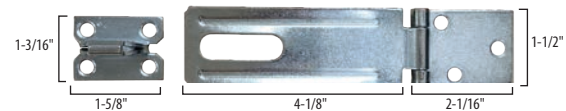

## Heavy-Duty Hasp And Staple

Item #	Staple (Length x Width)	Hasp (Length x Width)	Finish	Wt. lbs.	Qty
#50423	2-1/8" x 2-1/2"	8-3/4" x 2-1/8"	Zinc	1.21 lbs.	30



## Hasp And Staple With Swivel Lock

Item #	Staple (Length x Width)	Hasp (Length x Width)	Finish	Wt. lbs.	Qty
#50316	2" x 2"	8" x 2"	Zinc	0.67 lbs.	20



**J-Bolts With Washers And Nuts**

**Bare**

Item #	Size (Diameter x Length)	Width	Length	Pintle	Wt. lbs.	Qty.
#49346	5/8" x 6"	5/8"	6"	1-1/2"	0.87 lbs.	40
#49347	5/8" x 12"	5/8"	12"	1-1/2"	1.33 lbs.	20
#49352	3/4" x 12"	3/4"	12"	2"	2.02 lbs.	20
#49353	3/4" x 18"	3/4"	18"	2"	2.59 lbs.	10
#49457	7/8" x 12"	7/8"	12"	3"	3.00 lbs.	10



**Hot Dipped Galvanized**

Item #	Size (Diameter x Length)	Width	Length	Pintle	Wt. lbs.	Qty.
#49501	1/2" x 4-1/2"	1/2"	4-1/2"	1-1/2"	0.70 lbs.	20
#47940	5/8" x 4-1/2"	5/8"	4-1/2"	1-1/2"	0.81 lbs.	20
#49345	5/8" x 6"	5/8"	6"	1-1/2"	0.90 lbs.	40
#49348	5/8" x 12"	5/8"	12"	1-1/2"	1.31 lbs.	20
#47943	5/8" x 18"	5/8"	18"	1-1/2"	1.72 lbs.	10
#49351	3/4" x 12"	3/4"	12"	2"	1.69 lbs.	20
#47939	3/4" x 18"	3/4"	18"	2"	2.51 lbs.	10

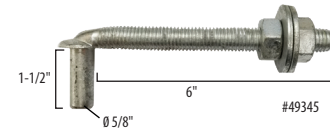

**Zinc Plated**

Item #	Size (Diameter x Length)	Width	Length	Pintle	Wt. lbs.	Qty.
#49458	1/2" x 4-1/2"	1/2"	4-1/2"	1-1/2"	0.53 lbs.	20
#47941	5/8" x 6"	5/8"	6"	1-1/2"	0.87 lbs.	20
<i>New</i> #81102	5/8" x 8"	5/8"	8"	1-1/2"	1.00 lbs.	20
#47942	5/8" x 12"	5/8"	12"	1-1/2"	1.00 lbs.	20*
#80051	5/8" x 12"	5/8"	12"	1-1/2"	1.00 lbs.	20
#47584	3/4" x 12"	3/4"	12"	2"	2.05 lbs.	20
#49354	3/4" x 18"	3/4"	18"	2"	2.51 lbs.	10

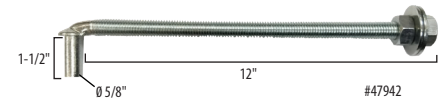

\*Washers and nuts not included

**Lag Hinge Pins**

**Bare**

Item #	Size (Diameter x Length)	Length	Pintle	Diameter	Wt. lbs.	Qty.
#49357	5/8" x 6"	6"	1-1/2"	5/8"	0.55 lbs.	20
#47586	3/4" x 6"	6"	2"	3/4"	1.00 lbs.	20



**Hot Dipped Galvanized**

Item #	Size (Diameter x Length)	Length	Pintle	Diameter	Wt. lbs.	Qty.
#49358	5/8" x 6"	6"	1-1/2"	5/8"	0.57 lbs.	20
#49360	3/4" x 6"	6"	2"	3/4"	1.00 lbs.	20

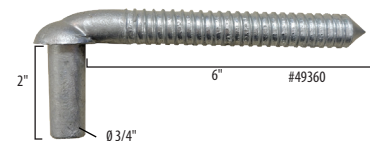

**Zinc Plated**

Item #	Size (Diameter x Length)	Length	Pintle	Diameter	Wt. lbs.	Qty.
#48660	5/8" x 6"	6"	1-1/2"	5/8"	0.55 lbs.	20
#49970	5/8" x 6"	6"	2"	5/8"	0.59 lbs.	100
#47585	3/4" x 6"	6"	2"	3/4"	1.03 lbs.	20
#80073	3/4" x 8"	8"	2"	3/4"	1.30 lbs.	20

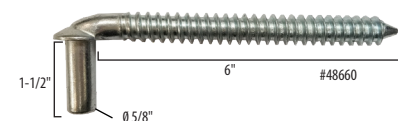

**Round Male Hinges - Bolt On**

Item #	Size (Pintle Diameter x Pipe OD)	Finish	Wt. lbs.	Qty.
#80151	5/8" x 1-3/8"	HDG	0.44 lbs.	10
#50344	5/8" x 1-3/8"	Zinc	0.60 lbs.	25
#50264	5/8" x 1-3/4"	Zinc	0.60 lbs.	50
#49924	5/8" x 2-3/8"	HDG	0.66 lbs.	10
#49925	5/8" x 2-7/8"	HDG	0.77 lbs.	10
<i>New</i> <i>New</i> #81076	3/4" x 2-3/8"	HDG	0.73 lbs.	10
#81077	3/4" x 2-37/8"	HDG	0.82 lbs.	10

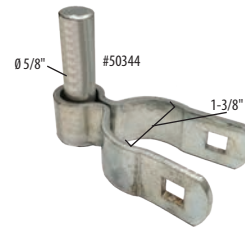

**Round Female Hinge - Bolt On**

Item #	Size (Pintle Insert x Pipe OD)	Finish	Wt. lbs.	Qty.
#49978	3/4" x 2"	HDG	0.75 lbs.	25

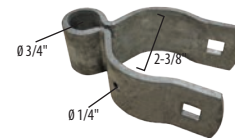

**Round Female Hinges - Bolt On**

Item #	Size (Pintle Insert x Pipe OD)	Finish	Wt. lbs.	Qty.
#49977	3/4" x 1-1/2"	HDG	0.75 lbs.	25
#80349	3/4" x 2"	Zinc	0.75 lbs.	25
#80153	5/8" x 1-3/8"	HDG	0.28 lbs.	25
#49976	5/8" x 1-3/4"	Zinc	0.33 lbs.	25



**Round Female Hinges - Bolt On**

Item #	Size (Pintle Insert x Pipe OD)	Finish	Wt. lbs.	Qty.
#49020	5/8" x 1-5/8"	HDG	0.55 lbs.	25
<i>New</i> #81113	5/8" x 1-5/8"	Zinc	0.44 lbs.	25
#49021	5/8" x 1-7/8"	HDG	0.55 lbs.	25
#48803	3/4" x 1-3/4"	Zinc	0.75 lbs.	25
#48804	3/4" x 2"	Zinc	0.90 lbs.	25



**Square Female Hinges - Bolt On**

Item #	Size (Pintle Insert x Tube Size)	Finish	Wt. lbs.	Qty.
#50267	5/8" x 1-1/2"	Zinc	0.71 lbs.	25
#50261	3/4" x 1-1/2"	Zinc	0.92 lbs.	50
#50265	3/4" x 2"	Zinc	0.65 lbs.	25



**Female Hinge Straps - Weld On**

Item #	Size (Pintle Insert x Pipe Open)	Finish	Depth	Wt. lbs.	Qty.
#49022	5/8" x 1-5/8"	HDG	1-1/2"	0.39 lbs.	25
#49986	5/8" x 1-3/4"	Zinc	1-1/2"	0.43 lbs.	50
#49023	5/8" x 1-7/8"	HDG	1-1/2"	0.40 lbs.	25
#48806	3/4" x 2"	HDG	2"	0.45 lbs.	25
#49987	3/4" x 2"	Zinc	1-1/2"	0.51 lbs.	25
#80636	3/4" x 2"	Bare	1-1/2"	0.52 lbs.	25



**Female Hinges With Weld On Plate**

Item #	Size (Pintle Insert)	Plate Size (Length x Width)	Finish	Wt. lbs.	Qty.
#49682	5/8"	2" x 1-1/2"	Bare	0.30 lbs.	50
#49681	3/4"	2" x 1-1/2"	Bare	0.41 lbs.	50



# HARDWARE PANEL ACCESSORIES

## Panel Clamps

Item #	Size	Hardware	Finish	Wt. lbs.	Qty.
#80402	1-5/8"	Yes	Bare	0.91 lbs.	50
#48988	1-5/8"	Yes	HDG	0.91 lbs.	50
#48989	1-7/8"	Yes	HDG	0.97 lbs.	50

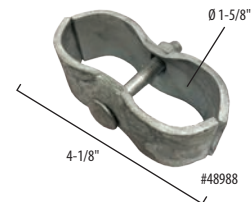

## Saddle Panel Clamps

Item #	Size	Hardware	Finish	Wt. lbs.	Qty.
#50010	1-5/8"	Yes	Zinc	0.73 lbs.	25
#80155	1-3/8"	No	HDG	0.26 lbs.	25



## Panel Adapters

Item #	Size	Finish	Wt. lbs.	Qty.
#48990	2-3/8" x 1-5/8"	HDG	1.08 lbs.	20
#49796	2-3/8" x 1-7/8"	HDG	1.08 lbs.	20

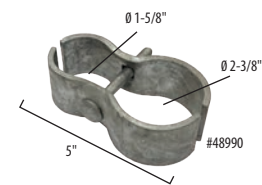

## Gate Collar

Item #	Size	Finish	Wt. lbs.	Qty.
#80156	1-3/8"	HDG	0.37 lbs.	25



## Gate Fork With Handle

Item #	Size (Length x Height)	Finish	Wt. lbs.	Qty.
#80154	4-1/4" x 1-1/2"	HDG	0.33 lbs.	25

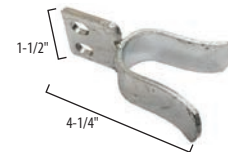

## Carriage Bolts

Item #	Size (Length x Diameter)	Finish	Wt. lbs.	Qty.
#50530	2-1/2" x 3/8"	Zinc	0.20 lbs.	25
#50531	3-1/2" x 3/8"	Zinc	0.24 lbs.	25

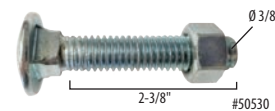

## Pipe Clamp With Clevis

Item #	Accommodates Pipe	Finish	Wt. lbs.	Qty.
#49744	2-3/4"	Powder Coat	2.10 lbs.	10



## Single Clevis

Item #	Style	Finish	Wt. lbs.	Qty.
#49748	Single	Powder Coat	0.45 lbs.	20





## Corral Pins

Item #	Style	Size (Length x Diameter)	Finish	Wt. lbs.	Qty.
#49870	Pin	4" x 3/4"	Zinc	0.16 lbs.	200
#49869	V-Pin	10-1/8" x 7/16"	Zinc	0.43 lbs.	100



## Lockable Pins

Item #	Type	Size (Length x Height)	Finish	Wt. lbs.	Qty.
#80384	Straight	5-7/8" x 2-1/2"	Powder Coat	0.43 lbs.	50
#80805	Bent	5-1/2" x 4-7/8"	Powder Coat	0.41 lbs.	50

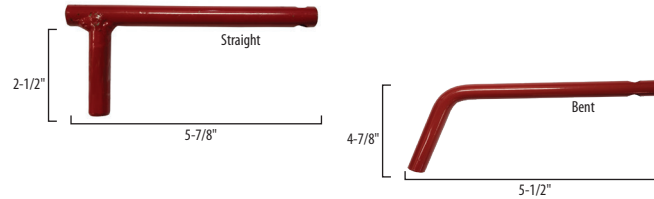

## Cane Drop Pin 8"

Item #	Size (Length x Height)	Finish	Wt. lbs.	Qty.
#50007	8-3/4" x 2-1/4"	Zinc	0.90 lbs.	25



## "P" Drop Pin 11"

Item #	Size (Length x Height)	Finish	Wt. lbs.	Qty.
#50135	11-1/4" x 2-5/8"	Zinc	1.09 lbs.	50



## Bent Drop Pin 9"

Item #	Size (Length x Height)	Finish	Wt. lbs.	Qty.
<i>New</i> #81106	9" x 3-3/4"	Zinc	0.69 lbs.	10

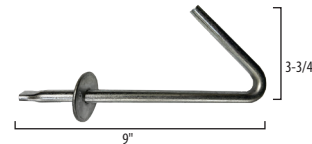

## Corral Drop Pin Brackets

Item #	Pipe Size	Size (Length x Height)	Finish	Wt. lbs.	Qty.
<i>New</i> #81104	1-1/4"	3-13/16" x 1"	Zinc	0.30 lbs.	100
#48657	1-3/4"	3-3/4" x 1"	Zinc	0.28 lbs.	150
<i>New</i> #81105	2-3/8"	3-5/8" x 1-1/2"	Zinc	0.44 lbs.	75

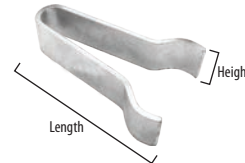

## Corral Drop Pin

Item #	Size (Length x Height)	Finish	Wt. lbs.	Qty.
#48658	9" x 1/2"	Zinc	0.73 lbs.	50

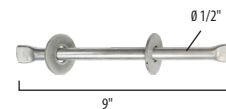

## Hinge Straps

Item #	Size (Depth x Height)	Thickness	Finish	Wt. lbs.	Qty.
#49975	1-1/2" x 1-1/2"	9ga	Zinc	0.21 lbs.	150
#50635	1-7/8" x 1"	11ga	Bare	0.13 lbs.	100
#49750	1-7/8" x 2-1/4"	11ga	Bare	0.29 lbs.	100



## Three-Way Bracket

Item #	Size (Depth x Height)	Thickness	Finish	Wt. lbs.	Qty.
#49972	1-1/2" x 1-9/16"	9ga	Zinc	0.61 lbs.	50

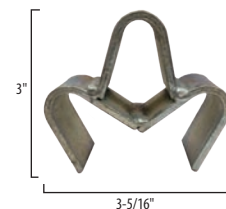

# HARDWARE GATE ACCESSORIES

## Keypad Mounts For Automatic Gates

Item #	Type	Size (Length x Width x Thickness)	Wt. lbs.	Qty.
#80634	Square	71-1/4" x 2" x 14ga	14.50 lbs.	1
#80635	Round	71-1/4" x 1.66" OD x 11ga	13.40 lbs.	1

These items do not qualify for free freight



## Ornamental Gate and Fence Accessories

### Heavy-duty Hinges



### Cast Iron Wheel



### Cast Iron Post Balls

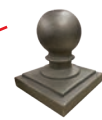

### Gate Latch



Design options are only limited to your imagination!

## Heavy-Duty Cane Bolt Kit

Item #	Size	Pin Size	Finish	Wt. lbs.	Qty.
<i>New</i> #81112	12"	3/4"	Bare	2.56 lbs.	20

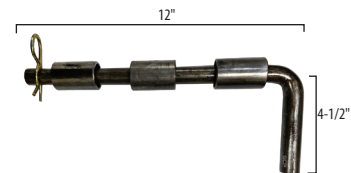

## Gate Anchor For Round Post

Item #	Size (Length x Width)	Fits Pipe	Finish	Wt. lbs.	Qty.
#50669	17" x 2-3/8"	1-3/4" & 2"	Zinc	3.65 lbs.	8

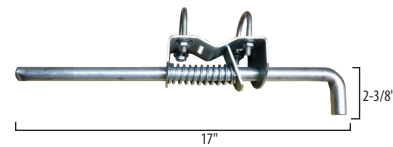

## Gate Cane Bolts With 2 Brackets

Item #	Size	Pin Size	Finish	Wt. lbs.	Qty.
#49822	12"	1/2"	Zinc	1.00 lbs.	20
#49823	18"	1/2"	Zinc	1.45 lbs.	10
#49824	24"	5/8"	Zinc	2.65 lbs.	10

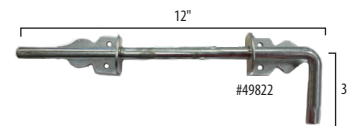

## Gate Cane Bolt With 3 Brackets

Item #	Size	Pin Size	Finish	Wt. lbs.	Qty.
<i>New</i> #81567	19"	1/2"	Powder Coat	1.69 lbs.	20

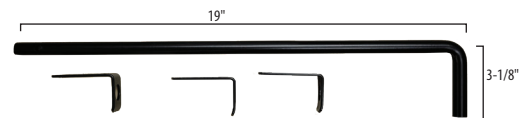

## Lockable Heavy-Duty Cane Bolt

Item #	Size	Pin Size	Finish	Wt. lbs.	Qty.
#80477	20"	3/4"	Painted	4.80 lbs.	10

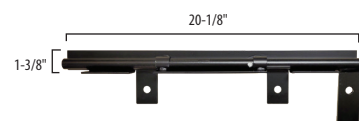

## Chain Keepers

Item #	Size (Length x Width)	Thickness	Chain Opening	Finish	Wt. lbs.	Qty.
#47677	4-3/8" X 3-3/16"	3/16"	1/4"	Bare	0.24 lbs.	60
#50008	4-7/16" X 3-1/4"	9ga	7/16"	Zinc	0.20 lbs.	100

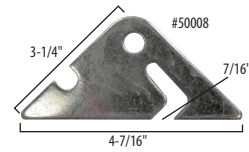

## Heavy-Duty Chain Keeper

Item #	Size (Length x Width)	Thickness	Chain Opening	Finish	Wt. lbs.	Qty.
#49876	4-3/4" x 3-7/16"	1/4"	5/16"	Bare	0.35 lbs.	100



## Three-Hole Chain Keeper

Item #	Size (Length x Width)	Thickness	Chain Opening	Finish	Wt. lbs.	Qty.
#49971	5-1/2" x 2-3/4"	7ga	5/16"	Bare	0.35 lbs.	100

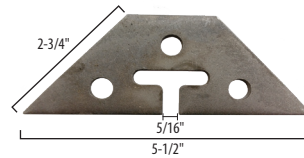

## Key Hole Chain Keeper With Notch

Item #	Size (Length x Width)	Thickness	Chain Opening	Finish	Wt. lbs.	Qty.
#50119	3" x 1-1/2"	3/16"	1/4"	Zinc	0.15 lbs.	100

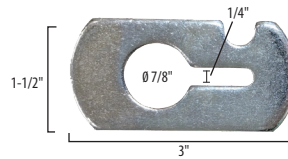

## Square Key Hole Chain Keeper

Item #	Size (Length x Width)	Thickness	Chain Opening	Finish	Wt. lbs.	Qty.
#50020	2-1/2" x 2-1/2"	3/16"	1/4"	Bare	0.23 lbs.	150

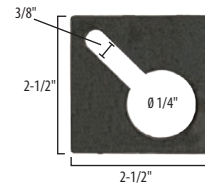

## Key Hole Chain Keepers

Item #	Size (Length x Width)	Thickness	Chain Opening	Finish	Wt. lbs.	Qty.
#50631	3-1/2" x 2"	3/16"	1-3/8"	Bare	0.20 lbs.	100
#80077	3-7/16" x 2"	1/4"	1-1/4"	Bare	0.32 lbs.	100

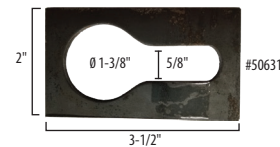

## Triangular Heavy-Duty Chain Keeper

Item #	Size (Length x Width)	Thickness	Chain Opening	Finish	Wt. lbs.	Qty.
#50021	7-7/8" x 5-11/16"	1/4"	1/2"	Bare	1.20 lbs.	25

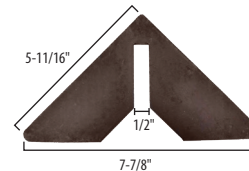

## Chain Keeper Heavy-Duty

Item #	Size (Length x Width)	Thickness	Chain Opening	Finish	Wt. lbs.	Qty.
#80209	4-5/8" x 3-3/8"	1/4"	1/4"	Bare	0.32 lbs.	50

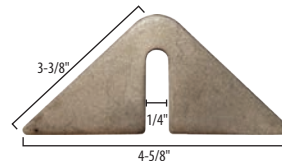

## Chains

Item #	Style	Size (Length x Thickness)	Finish	Wt. lbs.	Qty.
#49964	Light	30" x 3/16"	Zinc	0.54 lbs.	50
#50009	Light	34" x 7ga	Zinc	0.67 lbs.	50
#49973	Light	36" x 7ga	HDG	0.79 lbs.	50 / box 1,250 / drum
#49974	30 Proof	36" x 4ga	HDG	1.30 lbs.	50 / box 500 / drum



# HARDWARE WHEELS AND ROLLERS

## 11" Gate Spring Roller

Item #	Wt. Capacity	Finish	Wt. lbs.	Qty.
#50670	400 lbs.	Bare	4.85 lbs.	6

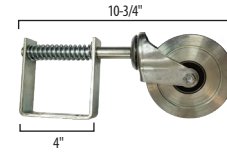

## 16" Gate Spring Roller

Item #	Wt. Capacity	Finish	Wt. lbs.	Qty.
#47823	100 lbs.	Bare	3.11 lbs.	10

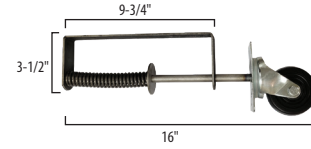

## Tall Gate Wheel

Item #	Finish	Wt. lbs.	Qty.
#80276	Powder Coat	10.60 lbs.	3

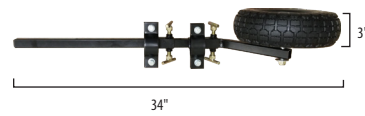

## 8" Gate Wheel

Item #	Finish	Wt. lbs.	Qty.
#50636	Zinc	3.85 lbs.	6

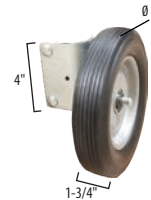

## 10" Semi Pneumatic Wheel

Item #	Wt. lbs.	Qty.
#80394	5.09 lbs.	1



## Covered Rubber Guide Rollers

Item #	Size (Length x Width x Height)	Finish	Wt. lbs.	Qty.
#50204	3-3/8" x 3" x 2-1/2"	HDG	2.00 lbs.	10
#50205	6-1/8" x 3" x 2-5/8"	HDG	3.40 lbs.	10

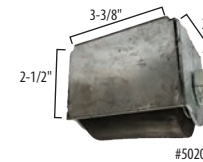

## Rubber Guide Rollers - No Mark

Item #	Size (Length x Width x Height)	Finish	Wt. lbs.	Qty.
#80474	3" x 2-1/4" x 2-7/16"	Bare	1.22 lbs.	40
#80475	6-5/8" x 1-3/8" x 2-7/8"	Bare	1.96 lbs.	20



## Rubber Guide Rollers

Item #	Size (Length x Width x Height)	Finish	Wt. lbs.	Qty.
#47821	3-3/8" x 2-1/2" x 3"	Bare	1.26 lbs.	20
#47822	6-1/2" x 2-1/2" x 3"	Bare	2.29 lbs.	10
#49114	11-3/4" x 2-3/8" x 2-5/8"	Bare	4.39 lbs.	12



## Cast Iron BBQ Wheels And Mounting Kit

Item #	Wheel Size (Diameter x Width)	Finish	Wt. lbs.	Qty.
#49503	4" x 1-1/4"	Bare	1.38 lbs.	10
#49504	5" x 1-1/4"	Bare	1.79 lbs.	10
#50400	Kit	Bare	1.05 lbs.	10 (Wheel Not Included)





**V-Groove Wheels - Cast Iron**

Item #	Wheel Size (Diameter x Width)	Working L.L. (Maximum)	Fits Box	Finish	Wt. lbs.	Qty.
#80227	3" x 1-1/2"	300 lbs.	#80228	Bare	1.69 lbs.	12
#47061	4" x 1-1/2"	600 lbs.	#48411 #80228	Bare	2.89 lbs.	8
#47062	6" x 2"	800 lbs.	#K0002	Bare	5.59 lbs.	2



**Premium V-Groove Wheels - Steel**

Item #	Wheel Size (Diameter x Width)	Fits Box	Finish	Wt. lbs.	Qty.
#49709	4" x 1-7/8"	#48411 #50342	Zinc	5.36 lbs.	8
#49844	6" x 1-3/4"	#50209	Zinc	12.30 lbs.	2

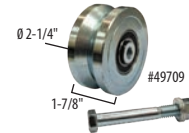

**Replacement Bolt**

Item #	Size (Length x Diameter)	Finish	Wt. lbs.	Qty.
<i>New</i> #81127	3-1/2" x 7/16"	Zinc	0.19 lbs.	200



**NEW ARRIVALS**  
*Shop Now*

See the newest additions on our website,  
[www.springcreekproducts.com](http://www.springcreekproducts.com)

**V-Groove Wheel Track**

Item #	Size (Length x Width)	Finish	Wt. lbs.	Qty.
#80767	9'10" x 3-5/8"	Zinc	13.30 lbs.	1

This item does not qualify for free freight.



**V-Groove Wheel Boxes**

**Bare**

Item #	Size	Box Size (Length x Width x Depth)	Fits Wheel	Wt. lbs.	Qty.
#80228	3" & 4"	5" x 2-1/4" x 3-1/8"	#80227, #47061, #49709	1.53 lbs.	8

**Hot Dipped Galvanized**

Item #	Size	Box Size (Length x Width x Depth)	Fits Wheel	Wt. lbs.	Qty.
#80698	3" & 4"	5" x 2-1/4" x 3-1/8"	#47061, 49709	1.41 lbs.	8
#80699	6"	7" x 2-7/8" x 4"	#47062	2.88 lbs.	2

**Powder Coat**

Item #	Size	Box Size (Length x Width x Depth)	Fits Wheel	Wt. lbs.	Qty.
#48411	4"	5" x 2-5/16" x 3-1/8"	#47061, #49709	1.76 lbs.	8
#K0002	6"	7" x 2-7/8" x 4"	#47062	2.88 lbs.	2
#50209	6"	7" x 2-5/16" x 4-1/8"	#49844	2.85 lbs.	2



# HARDWARE WHEELS AND ROLLERS

## Door Track Brackets

Item #	Track Type	Size (Height x Width x Depth)	Finish	Wt. lbs.	Qty.
#47854	(A) Single Splice	4-1/2" x 2" x 2"	HDG	0.71 lbs.	25
#48038	(B) Single Mount	4-1/2" x 2" x 2-1/8"	HDG	0.72 lbs.	25
#48080	(C) Single Ceiling	3-5/8" x 4-7/8" x 1-3/4"	HDG	1.13 lbs.	10
#48081	(D) Single Wall	7-3/16" x 3-3/8" x 1-3/4"	HDG	1.22 lbs.	10
#48082	(E) Double Wall	8-11/16" x 4-7/16" x 1-3/4"	HDG	2.04 lbs.	10

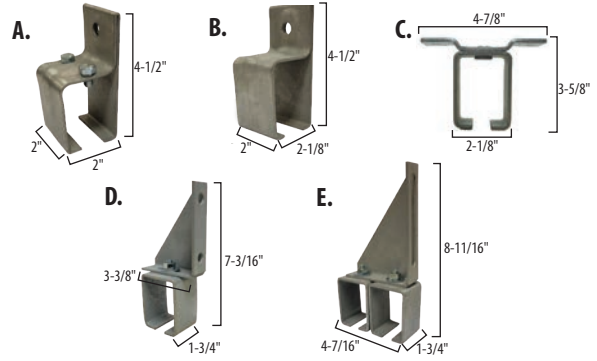

## Heavy-Duty Galvanized Door Tracks

Item #	Size	Thickness	Finish	Wt. lbs.	Qty.
#80908	6'	14ga	Zinc	11.88 lbs.	1
#49173	8'	14ga	Zinc	15.84 lbs.	1
#49174	10'	14ga	Zinc	19.80 lbs.	1
#49175	12'	14ga	Zinc	23.76 lbs.	1

These items do not qualify for free freight



## Door Stay Roller

Item #	Size (Length x Width x Height)	Finish	Wt. lbs.	Qty.
#80979	5-1/2" x 3-1/2" x 3-1/2"	Zinc	1.26 lbs.	20

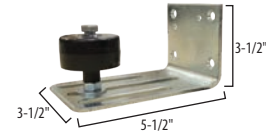

## Premium 4 Wheel Door Track Roller

Item #	Wt. Capacity	Finish	Wt. lbs.	Qty.
#47902	1,430 lbs.	Painted	1.06 lbs.	2

Works with most popular name brand door tracks.

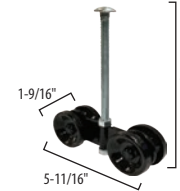

## Plastic Wheel Casters

Item #	Style	Wheel Size (Diameter x Width)	Plate Size (Length x Width)	Finish	Wt. lbs.	Qty.
#50063	Rigid	5" x 1-1/2"	4-1/2" x 3-3/4"	Zinc	2.21 lbs.	16
#50064	Swivel	5" x 1-1/2"	4-1/2" x 3-3/4"	Zinc	2.41 lbs.	16



## Rubber Wheel Casters - Swivel

Item #	Style	Wheel Size (Diameter x Width)	Plate Size (Length x Width)	Finish	Wt. lbs.	Qty.
#48628	Standard	3" x 1-1/4"	4" x 3-1/8"	Zinc	1.24 lbs.	12
#48629	Standard	4" x 1-1/4"	3-3/4" x 2-5/8"	Zinc	2.06 lbs.	12
#50091	Heavy-Duty	4" x 2"	4-1/2" x 4"	Zinc	4.00 lbs.	8



## Rubber Wheel Casters - Rigid

Item #	Wheel Size (Diameter x Width)	Plate Size (Length x Width)	Finish	Wt. lbs.	Qty.
#48627	3" x 1-1/4"	4" x 2-3/8"	Zinc	0.96 lbs.	12
#48630	4" x 1-3/16"	3-3/4" x 2-5/8"	Zinc	1.56 lbs.	12



## Rubber Wheel Casters - Locking Swivel

Item #	Style	Wheel Size (Diameter x Width)	Plate Size (Length x Width)	Finish	Wt. lbs.	Qty.
#80086	Standard	3" x 1-1/4"	4" x 3-1/8"	Zinc	1.26 lbs.	12
#50092	Heavy-Duty	4" x 2"	4-1/2" x 4"	Zinc	4.31 lbs.	8
#49730	Standard	4-7/8" x 1-1/4"	3-3/4" x 2-5/8"	Zinc	2.34 lbs.	10



**T-Post Driver - Heavy-Duty**

Item #	Length	Finish	Wt. lbs.	Qty.
#47935	30"	Powder Coat	14.00 lbs.	1

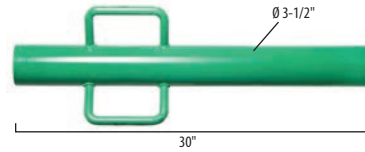

**T-Post Puller**

Item #	Size (Length x Width)	Finish	Wt. lbs.	Qty.
#80273	7-1/2" x 3-3/16"	Painted	2.36 lbs.	1

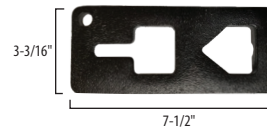

**Barbed Wire Roller**

*New*

Item #	Size (Length x Width)	Finish	Wt. lbs.	Qty.
#81429	36" x 15-1/4"	Powder Coat	3.56 lbs.	1

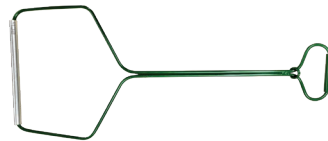

**Tie Wire Roll - 3.5#**

Item #	Size (Diameter x Length)	Finish	Wt. lbs.	Qty.
#81097	16ga x 330'	Bare	3.50 lbs.	20



**Wire Gripper**

Item #	Finish	Wt. lbs.	Qty.
#47623	Painted	0.84 lbs.	15



**Cable Puller - 1 Ton**

Item #	Finish	Wt. lbs.	Qty.
#80627	Zinc	5.01 lbs.	6



**Fence Stretchers**

Item #	Length	Finish	Wt. lbs.	Qty.
#80628	56"	Zinc	28.40 lbs.	1
#80629	66"	Zinc	37.00 lbs.	1
#80723	102"	Zinc	54.50 lbs.	1

These items do not qualify for free freight

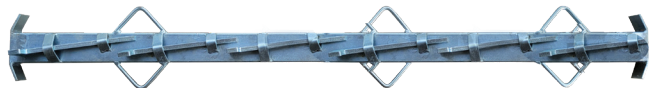

**Replacement Wedges**

Item #	Finish	Wt. lbs.	Qty.
#80630	Zinc	1.34 lbs.	20



**Fence Wire Stretcher**

Item #	Finish	Wt. lbs.	Qty.
#80978	Powder Coat	9.24 lbs.	1



*New*

**Wire Fence Keepers**

Item #	Size	Finish	Wt. lbs.	Qty.
#81477	4'	Bare	7.88 lbs.	1
#81478	5'	Bare	10.00 lbs.	1



# HARDWARE FENCE ACCESSORIES



## Fence Connector - Pinched

Item #	Size (Fits Inside)	Accommodates Gauges	O.D.	Thickness	Finish	Wt. lbs.	Qty.
<i>New</i> #80382	1.05"	16ga, 14ga, 12ga	1.01"	13ga	Bare	0.67 lbs.	50



## Fence Connectors

Item #	Size (Fits Inside)	Accommodates Gauges	O.D.	Thickness	Finish	Wt. lbs.	Qty.
#50108	1.25"	16ga, 14ga, 12ga	1.05"	14ga	Bare	0.43 lbs.	60
#50109	1.5" and 1.66"	14ga	1.315"	13ga	Bare	0.75 lbs.	50
#80142	1.25"	16ga, 14ga, 12ga	1.05"	13ga	Bare	0.49 lbs.	60

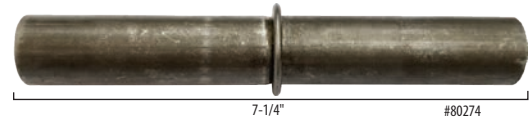

## Fence Connectors - Pressed

Item #	Size (Fits Inside)	Accommodates Gauges	O.D.	Thickness	Finish	Wt. lbs.	Qty.
#80274	1.25"	16ga, 14ga, 12ga	1.05"	16ga	Bare	0.31 lbs.	60
#81073	1.50"	14ga	1.25"	16ga	Bare	0.39 lbs.	60
#80275	1.66"	16ga, 14ga, 12ga	1.375"	16ga	Bare	0.43 lbs.	60

## Pressed Elbow - 90°

Item #	Pipe Size	O.D.	Finish	Wt. lbs.	Qty.
#49488	1-1/4"	1.66"	Bare	0.53 lbs.	60 / box 1,400 / drum



## Ornamental Schedule 40 Steel Tees

Item #	Pipe Size	O.D.	Finish	Wt. lbs.	Qty.
#48040	1"	1-5/16"	Painted	0.37 lbs.	50
#48041	1-1/4"	1-5/8"	Painted	0.65 lbs.	12
#48042	1-1/2"	1-7/8"	Painted	0.92 lbs.	12
#48043	2"	2-3/8"	Painted	1.49 lbs.	8
#48044	2-1/2"	2-7/8"	Painted	2.68 lbs.	6



## Ornamental Schedule 40 Elbows

Item #	Pipe Size	Degree	O.D.	Center Line Radius	Inside Radius	Finish	Wt. lbs.	Qty.
#47957	1-1/4"	45°	1-5/8"	1.9"	1.12"	Painted	0.28 lbs.	40
#47958	1-1/2"	45°	1-7/8"	2.25"	1.35"	Painted	0.40 lbs.	40
#47040	1/2"	90°	7/8"	1.5"	1"	Painted	0.18 lbs.	50
#47041	3/4"	90°	1-1/16"	1.1"	.60"	Painted	0.22 lbs.	50
#47042	1"	90°	1-5/16"	1.5"	.80"	Painted	0.33 lbs.	30
#47043	1-1/4"	90°	1-5/8"	1.9"	1.1"	Painted	0.55 lbs.	30
#47044	1-1/2"	90°	1-7/8"	2.25"	1.35"	Painted	0.79 lbs.	20
#47045	2"	90°	2-3/8"	3"	1.8"	Painted	1.43 lbs.	20
#47046	2-1/2"	90°	2-7/8"	3.75"	2.3"	Painted	2.84 lbs.	10
#47047	3"	90°	3-1/2"	4.5"	2.75"	Painted	4.47 lbs.	5
#47048	4"	90°	4-1/2"	6"	3.75"	Painted	8.47 lbs.	1
#47049	6"	90°	6-5/8"	9"	5.7"	Painted	22.20 lbs.	1





*If you need help with an order, have questions about our products,  
or have an inquiry about setting up an account,  
please contact a member of our team today!  
We would love to hear from you!  
1-866-651-6702 or sales@springcreekproducts.com*

### Steel Lock Boxes With Guard

Item #	Size (Width x Height)	Type	Depth	Backset	Opening	Finish	Wt. lbs.	Qty.
#49452	3-1/2" x 3-1/2"	Single	1-1/4"	2-3/8"	2-1/8"	Bare	0.91 lbs.	10
#49495	4-1/4" x 3-3/8"	Single	1-1/2"	2-3/8"	2-1/8"	Bare	0.90 lbs.	10
#49451	4-1/4" x 4-1/2"	Single	1"	2-3/8"	2-1/8"	Bare	0.93 lbs.	10
#49454	4-1/2" x 6-3/4"	Double	1-1/4"	2-3/8"	2-1/8"	Bare	1.63 lbs.	10
#49496	4-1/4" x 6-7/8"	Double	1-1/2"	2-3/8"	2-1/8"	Bare	1.50 lbs.	10
#49453	4-1/2" x 7-1/2"	Double	1"	2-3/8"	2-1/8"	Bare	1.59 lbs.	40

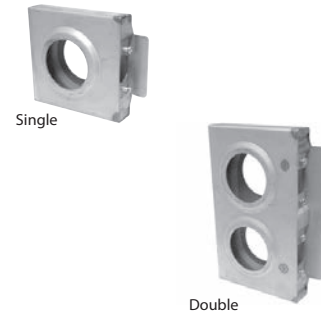

### Pipe Panel Pals

This product was proudly developed inhouse to simplify fence building.  
There are a wide range of size options that allow for the use of different pipe diameters for your vertical and horizontal pipes.

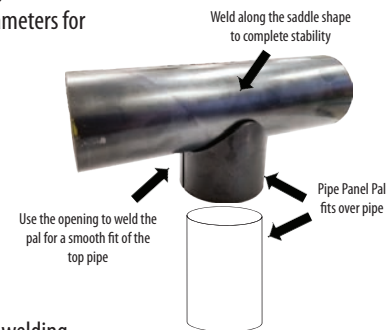

#### Standard\*

Item #	Size (Fits Over)	Holds	Thickness	Finish	Wt. lbs.	Qty.
#80001	1-1/4"	1-1/4"	11ga	Bare	0.15 lbs.	50
#80002	1-5/8"	1-5/8"	11ga	Bare	0.28 lbs.	50
#80003	1-7/8"	1-7/8"	11ga	Bare	0.32 lbs.	50
#80004	2"	2"	11ga	Bare	0.37 lbs.	100
#80005	2-3/8"	2-3/8"	11ga	Bare	0.45 lbs.	50
#80136		2-7/8"	10ga	Bare	0.56 lbs.	50
#80137		3-1/2"	10ga	Bare	0.58 lbs.	50
#80139		4-1/2"	8ga	Bare	0.71 lbs.	50
#80006	2-7/8"	2-7/8"	11ga	Bare	0.67 lbs.	25
#80138		3-1/2"	11ga	Bare	0.67 lbs.	50
#80140		4-1/2"	9ga	Bare	0.85 lbs.	50
#80007	3"	3"	10ga	Bare	0.70 lbs.	50
#80008	3-1/2"	3-1/2"	10ga	Bare	0.85 lbs.	25
#80009	4"	4"	10ga	Bare	1.10 lbs.	25
#80010	4-1/2"	4-1/2"	9ga	Bare	1.44 lbs.	25

- Made of carbon steel for easy welding
- Less expensive than cast steel
- Resists cracking associated with similar cast iron products
- Preformed saddle fits perfectly every time saving hours of cutting and welding labor
- \*The 90 degree end slips over standard size pipes of any wall thickness and the saddle is shaped to fit perfectly against the mating pipe forming a perfect Tee every time.
- \*Pipe can be left unwelded at one end to allow for expansion and contraction in extreme weather over long distances
- \*Pipe can be left unwelded at both ends allowing the horizontal pipe to act as a hinge over waterways
- \*Slot can be turned down to allow for drainage
- \*Horizontal pipes don't have to be cut accurately as the saddles allow for a large tolerance on the length

#### Transitional Cap

Item #	Size (Mates To)	Holds	Thickness	Finish	Wt. lbs.	Qty.
#80363	2-7/8"	2-3/8"	11ga	Bare	0.22 lbs.	100



# HARDWARE CABLE / FENCE CLIPS

## Deluxe Cable Clip

Item #	Accommodates Cable/Rod	Size (Length x Width)	Thickness	Finish	Wt. lbs.	Qty.
#46442	3/4"	4" x 3/4"	1/8"	Bare	0.11 lbs.	500



## Fence Clip

Item #	Accommodates Pipe	Size (Length x Width)	Thickness	Finish	Wt. lbs.	Qty.
#49028	1-1/4" O.D.	5-3/8" x 1"	12ga	Bare	0.17 lbs.	200



## Cable Clips

Item #	Accommodates Pipe	Size (Length x Diameter)	Finish	Wt. lbs.	Qty.
#45919 #46597	3/4" O.D.	2-7/8" x 1/4"	Bare	0.05 lbs.	300/box 13,500/drum
#46586 #46598	1" O.D.	4" x 5/16"	Bare	0.11 lbs.	200/box 12,150/drum
#47675	1" O.D.	4-7/16" x 3/8"	Bare	0.17 lbs.	210



## Continuous Cable Clips

Item #	Accommodates Pipe	Size (Length x Width)	Finish	Wt. lbs.	Qty.
#80124	1/2"	2-1/8" x 3/4"	Bare	0.04 lbs.	100
#80125	5/8"	2-5/8" x 7/8"	Bare	0.07 lbs.	100
#80126	3/4"	3" x 1"	Bare	0.12 lbs.	100
#80127	1"	4-1/8" x 1-1/4"	Bare	0.24 lbs.	100

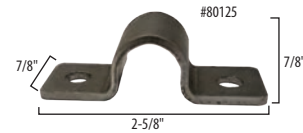

## Continuous Fence Clips - Square Ends

Item #	Size (O.D.)	Gauge	Hole	Finish	Wt. lbs.	Qty.
#46994	1-1/4"	12	1/4"	Bare	0.10 lbs.	200
#49841	1-1/4"	10	3/8"	Bare	0.20 lbs.	100
#50532	1-1/2"	10	3/8"	Bare	0.20 lbs.	100
#46995	1-5/8"	12	1/4"	Bare	0.12 lbs.	400
#49874	1-5/8"	10	1/4"	Bare	0.20 lbs.	200
#80028	1-5/8"	10	3/8"	Bare	0.23 lbs.	100
#46996	1-7/8"	12	1/4"	Bare	0.14 lbs.	200
#49468	2-3/8"	3/16"	3/8"	Bare	0.64 lbs.	50
<i>New</i> #81117	2-7/8"	3/16"	5/16"	Bare	0.70 lbs.	50



## Continuous Fence Clips - Round Ends

Item #	Size (O.D.)	Gauge	Hole	Finish	Wt. lbs.	Qty.
#49135	1-1/4"	10	1/4"	Bare	0.18 lbs.	200
#50619	1-1/4"	10	3/8"	Bare	0.17 lbs.	200



## Continuous Fence Clips - Square

Item #	Size (SQ)	Gauge	Hole	Finish	Wt. lbs.	Qty.
#50222	1"	12	3/8"	Bare	0.23 lbs.	100
#50223	1-1/4"	12	3/8"	Bare	0.28 lbs.	100
#50224	1-1/2"	12	3/8"	Bare	0.29 lbs.	100



## Pipe Clips

Item #	Accommodates Pipe	Size (Length x Diameter)	Finish	Wt. lbs.	Qty.
#50427	1-1/4" O.D.	4-7/8" x 5/16"	Bare	0.13 lbs.	100
#49467	2-3/8" O.D.	7-1/4" x 3/8"	Bare	0.30 lbs.	200



**Fence Clips**

Item #	Accommodates Pipe	Size (Length x Width)	Thickness	Finish	Wt. lbs.	Qty.
#80395	2-3/8" O.D.	6" x 3/4"	3/16"	Bare	0.31 lbs.	100
#80396	2-7/8" O.D.	7-3/8" x 3/4"	3/16"	Bare	0.41 lbs.	100

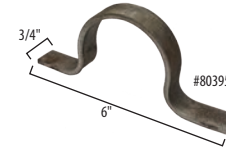

**Lag Bolts For Continuous Fence Clips**

Item #	Size (Diameter x Length)	Finish	Wt. lbs.	Qty.
#50353	5/16" x 2-1/2"	Zinc	0.04 lbs.	50
#50354	5/16" x 3"	Zinc	0.01 lbs.	50
#50350	3/8" x 2"	Zinc	0.04 lbs.	50
#50351	3/8" x 2-1/2"	Zinc	0.06 lbs.	50
#50352	3/8" x 3"	Zinc	0.10 lbs.	50

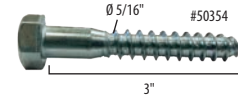

**Plastic Plugs**

Item #	Size (Fits Inside)	Gauge	Type	Wt. lbs.	Qty.
#48059	1/2"	16ga	Square	0.01 lbs.	100
#50077	3/4"	16ga, 14ga	Square	0.01 lbs.	200
#50078	5/8"	16ga, 14ga	Square	0.01 lbs.	300
#50079	1"	14ga	Square	0.01 lbs.	100
#50080	1-1/4"	14ga, 11ga	Square	0.01 lbs.	100
#50081	1-1/2"	16ga, 14ga, 11ga	Square	0.01 lbs.	100
#80443	1-3/4"	20ga - 14ga	Square	0.01 lbs.	500
#50082	2"	14ga, 11ga	Square	0.03 lbs.	50
#48405	3"	14ga	Square	0.04 lbs.	200
#48361	4"	3/16", 1/4"	Square	0.22 lbs.	100



#50083	2" x 1"	14ga, 11ga	Rectangular	0.02 lbs.	100
<i>New</i> #81716	3" x 1"	14ga - 10ga	Rectangular	0.04 lbs.	400
#80444	4" x 2"	14ga, 11ga	Rectangular	0.04 lbs.	250



#50162	1"	14ga, 11ga	Round	0.01 lbs.	100
#50163	1-1/4"	14ga, 11ga	Round	0.01 lbs.	100
#50164	1-1/2"	14ga, 11ga	Round	0.01 lbs.	100
<i>New</i> #81593	1-5/8"	20ga - 14ga	Round	0.01 lbs.	100
#80442	1-3/4"	20ga - 14ga	Round	0.01 lbs.	1,000
#50165	2"	14ga, 11ga	Round	0.03 lbs.	50
<i>New</i> #81594	2-3/8"	14ga - 10ga	Round	0.03 lbs.	50



*Retailer, Wholesaler, or Manufacturer,  
We've got you covered!  
Call us today to set up an account!  
1-866-651-6702*

**Plastic Pyramid Caps**

Item #	Size (Fits Over)	Height	Wt. lbs.	Qty.
#50440	1-1/2"	1"	0.01 lbs.	100
#50441	2"	1-1/4"	0.01 lbs.	48
#50442	3"	1-1/2"	0.10 lbs.	20



# HARDWARE POST CAPS

## Dome Post Caps

Item #	Cap Size	Thickness	Finish	Wt. lbs.	Qty.
#45938	1-5/8" OD	12ga	Bare	0.14 lbs.	200 / box
#45940	1-7/8" OD	12ga	Bare	0.14 lbs.	200 / box
#45942 #45943	2-3/8" OD	12ga	Bare	0.25 lbs.	100 / box 3,400 / drum
#45944 #45945	2-7/8" OD	12ga	Bare	0.33 lbs.	100 / box 1,900 / drum
#45946 #45947	3-1/2" OD	12ga	Bare	0.40 lbs.	100 / box 1,500 / drum
#46450 #46451	4" OD	12ga	Bare	0.49 lbs.	50 / box 1,250 / drum
#45948 #45949	4-1/2" OD	12ga	Bare	0.66 lbs.	50 / box 1,200 / drum
#46452	5" OD	12ga	Bare	0.82 lbs.	40 / box
#45950 #45951	5-1/2" OD	12ga	Bare	0.99 lbs.	20 / box 550 / drum
#45952	6-5/8" OD	12ga	Bare	1.25 lbs.	20 / box
#49218	8-5/8" OD	11ga	Bare	2.06 lbs.	10 / box



## Low Profile Post Caps

Item #	Cap Size	Thickness	Finish	Wt. lbs.	Qty.
#49445	1-5/8" OD	12ga	Bare	0.10 lbs.	400
#47605	1-7/8" OD	12ga	Bare	0.12 lbs.	400
#47606	2-3/8" OD	12ga	Bare	0.14 lbs.	261
#47607	2-7/8" OD	12ga	Bare	0.17 lbs.	180
#47608	3-1/2" OD	12ga	Bare	0.21 lbs.	114
#47609	4-1/2" OD	12ga	Bare	0.51 lbs.	72



## Flat Disc Post Caps

Item #	Cap Size	Thickness	Finish	Wt. lbs.	Qty.
#49444	1-5/8" OD	12ga	Bare	0.10 lbs.	420
#47595	1-7/8" OD	12ga	Bare	0.12 lbs.	420
#47596	2-3/8" OD	12ga	Bare	0.14 lbs.	270
#47597	2-7/8" OD	12ga	Bare	0.17 lbs.	180
#47598	3-1/2" OD	12ga	Bare	0.21 lbs.	120
#47599	4-1/2" OD	12ga	Bare	0.51 lbs.	72



## Small Diameter Flat Post Caps

Item #	Fits Post Size (inside)	Thickness	Finish	Wt. lbs.	Qty.
#80245	1-1/2" OD	12ga	Bare	0.05 lbs.	50
#80158	1-7/8" OD	12ga	Bare	0.07 lbs.	50
#80159	2-3/8" OD	12ga	Bare	0.13 lbs.	100
#80160	2-7/8" OD	12ga	Bare	0.17 lbs.	100
#80161	3-1/2" OD	12ga	Bare	0.27 lbs.	100
#80162	4-1/2" OD	12ga	Bare	0.49 lbs.	50
#80163	6-5/8" OD	12ga	Bare	0.95 lbs.	50



Caps fit within the surface, does NOT cover the entire tube surface.



**Square Flat Post Caps**

Item #	Fits Post Size	Thickness	Finish	Wt. lbs.	Qty.
#80166	1-1/2"	11ga	Bare	0.06 lbs.	50
#80167	2"	11ga	Bare	0.11 lbs.	50
#80168	2-1/2"	12ga	Bare	0.17 lbs.	50
#80169	3"	12ga	Bare	0.25 lbs.	50
#80170	3-1/2"	11ga	Bare	0.39 lbs.	50
#80171	4"	11ga	Bare	0.51 lbs.	50
#80172	6"	12ga	Bare	1.04 lbs.	20

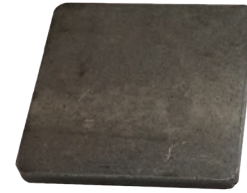

**Rectangular Flat Post Caps**

Item #	Fits Post Size	Thickness	Finish	Wt. lbs.	Qty.
#80173	2" x 1"	12ga	Bare	0.06 lbs.	50
#80246	3" x 1"	11ga	Bare	0.12 lbs.	50
#80174	3" x 1-1/2"	12ga	Bare	0.11 lbs.	50
#80247	3" x 2"	11ga	Bare	0.18 lbs.	50
#80175	4" x 2"	12ga	Bare	0.25 lbs.	50
#80176	6" x 2"	11ga	Bare	0.34 lbs.	50



**Steel Pressed Post Caps**

Item #	Size (Fits Over Square)	Height	Finish	Wt. lbs.	Qty.
#O0040	1"	3/8"	Bare	0.01 lbs.	20
#O0029	1-1/2"	5/8"	Bare	0.03 lbs.	20
#O0030	2"	1"	Bare	0.07 lbs.	20
#O0031	3"	1-1/16"	Bare	0.13 lbs.	30
#O0027	4"	1-5/8"	Bare	0.31 lbs.	15

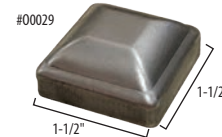

*New*

**Steel Pressed Post Caps**

Item #	Size (Fits Over Square)	Height	Finish	Wt. lbs.	Qty.
#81071	1-1/4"	9/16"	HDG	0.03 lbs.	100
#81072	1-1/2"	3/4"	HDG	0.04 lbs.	100

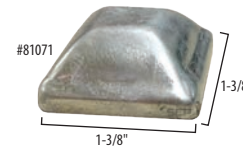

**Pressed Post Caps**

Item #	Size (Fits Over)	Height	Finish	Wt. lbs.	Qty.
#80625	1.90"	1-1/2"	Bare	0.19 lbs.	50
#80267	2-3/8"	1-9/16"	Bare	0.27 lbs.	50
#80268	2-7/8"	1-5/8"	Bare	0.34 lbs.	50
#80269	3-1/2"	1-15/16"	Bare	0.53 lbs.	50
#80270	4-1/2"	2-9/16"	Bare	0.81 lbs.	50



**Pressed Post Caps**

Item #	Size (Fits Over)	Height	Finish	Wt. lbs.	Qty.
#50279	2-3/8"	1-7/16"	HDG	0.27 lbs.	50
#50280	2-7/8"	1-1/2"	HDG	0.35 lbs.	50
#50281	3-1/2"	1-1/2"	HDG	0.49 lbs.	50
#50390	4-1/2"	1-3/4"	HDG	0.81 lbs.	50



# HARDWARE POST CAPS

## Welded Post Caps

Item #	Size (Fits Over)	Height	Finish	Wt. lbs.	Qty.
#80775	1-1/2"	3/8"	Bare	0.05 lbs.	50
#80776	1-3/4"	3/8"	Bare	0.09 lbs.	50
#80778	1-3/4"	3/8"	Galv	0.06 lbs.	50
#80777	2"	5/16"	Bare	0.08 lbs.	50



## Cast Iron Pyramid Post Caps

Item #	Size (Fits Over Square)	Height	Finish	Wt. lbs.	Qty.
#O0021	1"	3/4"	Bare	0.12 lbs.	250
#O0108	1-1/4"	1-1/2"	Bare	0.18 lbs.	40
#O0022	1-1/2"	1-1/8"	Bare	0.23 lbs.	120
#O0023	2"	1-1/8"	Bare	0.47 lbs.	100
#O0024	2-1/2"	1-3/8"	Bare	0.58 lbs.	40
#O0025	3"	1-3/8"	Bare	0.89 lbs.	40
#O0026	4"	1-1/2"	Bare	1.50 lbs.	25
#O0039	6"	1-3/4"	Bare	2.90 lbs.	9

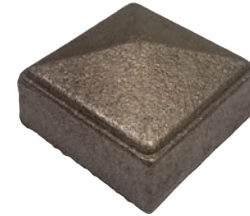

## Cast Iron Post Balls

Item #	Size (Fits Over Square)	Height	Ball Diameter	Finish	Wt. lbs.	Qty.
#O0106	1"	2-7/16"	1-1/8"	Bare	0.42 lbs.	25
#O0107	1-1/4"	2-1/2"	1-1/8"	Bare	0.66 lbs.	60
#O0015	1-1/2"	3-1/8"	1-3/8"	Bare	0.89 lbs.	32
#O0016	2"	3-3/4"	1-3/4"	Bare	1.50 lbs.	25
#O0017	2-1/2"	4-3/8"	2"	Bare	2.76 lbs.	15
#O0018	3"	5"	2-1/2"	Bare	2.08 lbs.	12
#O0019	4"	5-1/2"	3"	Bare	4.06 lbs.	10
#O0020	6"	7"	4"	Bare	10.38 lbs.	2



## 1/2" Square Tubing Rings

Item #	O.D.	Finish	Wt. lbs.	Qty.
#O0169	3-1/4"	Bare	0.18 lbs.	1
#O0170	3-1/2"	Bare	0.20 lbs.	200
#O0171	4"	Bare	0.21 lbs.	150
#O0172	4-1/2"	Bare	0.23 lbs.	200
#O0173	5"	Bare	0.28 lbs.	150
#O0182	6"	Bare	0.32 lbs.	150
#O0183	8"	Bare	0.45 lbs.	80



## Cast Iron Baluster Collars

Item #	Type	Fits Over Square	Base	Height	Finish	Wt. lbs.	Qty.
#O0028	(A) Square	1/2"	1-1/2"	1-3/4"	Bare	0.31 lbs.	120
#O0181	(B) Square Plain	5/8"	1-9/16"	1-3/4"	Bare	0.44 lbs.	100
#O0036	(B) Square Plain	3/4"	1-3/4"	1-13/16"	Bare	0.37 lbs.	70

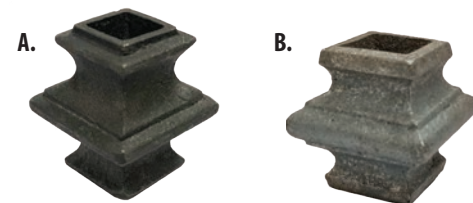

## Panel Mount Brackets

Item #	Size (Fits Into)	Mount Size (Width x Length)	Finish	Wt. lbs.	Qty.
#50289	1"	1" x 2-1/4"	Powder Coat	0.20 lbs.	100
#80478	1-1/4"	1-1/4" x 2-1/2"	Bare	0.27 lbs.	100
#80479	1-1/2"	1-1/2" x 2-3/4"	Bare	0.38 lbs.	100
#80480	2"	2" x 4"	Bare	0.63 lbs.	100





Item #	Cast Iron Finial Type	Fits Over Square	Base	Width	Height	Finish	Wt. lbs.	Qty.
#O0003	(A) Banana Peel	1/2"	1"	2-1/4"	3-3/8"	Bare	0.30 lbs.	50
#O0009	(A) Banana Peel	3/4"	1-1/4"	2-1/2"	4"	Bare	0.40 lbs.	50
#O0004	(B) Triad	1/2"	1"	2"	4-1/4"	Bare	0.31 lbs.	100
#O0010	(B) Triad	3/4"	1-1/4"	1-7/8"	3-7/8"	Bare	0.28 lbs.	100
#O0086	(C) Umbrella	3/4"	1-1/4"	3-3/4"	5-3/4"	Bare	0.66 lbs.	50
#O0007	(D) Pineapple	1/2"	1"	1"	1-1/8"	Bare	0.31 lbs.	150
#O0014	(D) Pineapple	3/4"	1-1/4"	1-1/4"	2-3/8"	Bare	0.44 lbs.	100
#O0088	(E) Spear, Open Body	1/2"	7/8"	1-1/2"	3-5/8"	Bare	0.29 lbs.	120
#O0082	(F) Roman w/ Octagon Base	3/4"	1-1/4"	2-3/4"	6"	Bare	0.79 lbs.	50
#O0105	(G) Square Pyramid	3/4"	1-1/2"	1-3/4"	5"	Bare	1.06 lbs.	40



Item #	Cast Iron Finial Type	Fits Over Square	Base	Width	Height	Finish	Wt. lbs.	Qty.
#O0083	(A) Arrow Square	1/2"	1"	3"	6"	Bare	0.53 lbs.	70
#O0104	(B) Roman Square Base	1/2"	1"	2-1/8"	4-1/4"	Bare	0.35 lbs.	100
#O0077	(C) Spear	3/4"	1-1/8"	2-5/8"	5-1/2"	Bare	0.70 lbs.	50
#O0001	(D) Quad with Ball	1/2"	1"	1"	4"	Bare	0.28 lbs.	120
#O0008	(D) Quad with Ball	3/4"	1-1/8"	1-1/8"	4-1/8"	Bare	0.30 lbs.	100
#81150	(D) Quad with Ball	3/4"	1"	1"	4"	Plastic	0.03 lbs.	20
#O0002	(E) Quad-No Ball	1/2"	1"	1"	4"	Bare	0.22 lbs.	120
#O0011	(E) Quad-No Ball	3/4"	1-1/8"	1-1/8"	4-1/4"	Bare	0.30 lbs.	50
#O0075	(F) Sloped Quad	1/2"	3/4"	7/8"	3-3/4"	Bare	0.32 lbs.	120
#O0102	(G) Wide Quad with Ball	3/4"	1-1/4"	1-7/8"	5-3/4"	Bare	0.93 lbs.	30

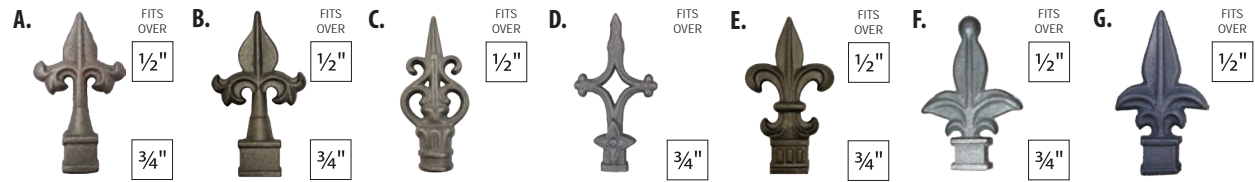

Item #	Cast Iron Finial Type	Fits Over Square	Base	Width	Height	Finish	Wt. lbs.	Qty.
#O0005	(A) Boy Scout	1/2"	1"	2-5/8"	4-1/2"	Bare	0.33 lbs.	100
#O0012	(A) Boy Scout	3/4"	1-1/8"	2-3/4"	4-3/4"	Bare	0.43 lbs.	80
#O0079	(B) Rounded Boy Scout	1/2"	7/8"	3"	4-3/4"	Bare	0.39 lbs.	100
#O0080	(B) Rounded Boy Scout	3/4"	3"	3"	5"	Bare	0.50 lbs.	60
#O0087	(C) Lyre	1/2"	Ø 1-1/8"	2-3/8"	5-1/2"	Bare	0.68 lbs.	60
#O0093	(D) Slotted Cross	3/4"	1-1/4"	3-1/4"	6-1/8"	Bare	1.00 lbs.	40
#O0098	(E) Traditional	1/2"	1-1/8"	3-1/4"	5-1/4"	Bare	0.68 lbs.	50
#O0099	(E) Traditional	3/4"	1-1/8"	3-1/4"	5-1/4"	Bare	0.77 lbs.	50
#O0006	(F) Fleur-de-lis	1/2"	1-1/8"	3"	4-1/2"	Bare	0.45 lbs.	80
#O0013	(F) Fleur-de-lis	3/4"	1-1/8"	3"	4-3/4"	Bare	0.51 lbs.	80
#O0076	(G) Fleur-de-lis No Ball	1/2"	1"	2-1/4"	4"	Bare	0.45 lbs.	100

# Hand Forged Rustic Hardware

If these doors could talk, the stories they could tell!

Many of these doors are over 500 years old. They all started out new and full of hope. They witnessed history and never gave up their secrets.

This inspired us to search the globe for artists that still fabricate metal hardware one unique handcrafted piece at a time using methods that date back to the Iron Age.

Start your story and who knows what your doors will see in the next 500 years!



## Door Pulls

Item #	Style	Size (Length x Depth)	Finish	Wt. lbs.	Qty.
#80667	(A) Simple	10-7/16" x 2-1/4"	Bare	2.06 lbs.	1
#80664	(B) Straight	10-5/16" x 2-3/4"	Bare	2.29 lbs.	1
#80677	(C) Classic	12-1/4" x 3-7/8"	Bare	3.46 lbs.	1
#80656	(D) Curled	10" x 1-3/4"	Bare	1.03 lbs.	10
#80675	(E) Classic	11-1/2" x 3-1/8"	Bare	2.91 lbs.	10



## Hammered Push Plates

Item #	Type	Size (Length x Width)	Thickness	Finish	Wt. lbs.	Qty.
#80693	(A) Italian	14-1/4" x 4-1/4"	3/16"	Bare	2.41 lbs.	10
#80695	(B) Simple	24-1/4" x 3-3/4"	8ga	Bare	3.69 lbs.	10

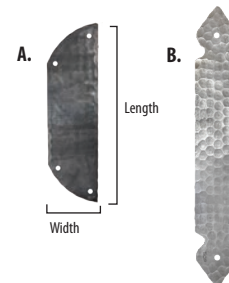

## Hammered "T" Plate

Item #	Size (Length x Width)	Thickness	Finish	Wt. lbs.	Qty.
#80659	14-1/4" x 10-1/4"	9ga	Bare	2.50 lbs.	10

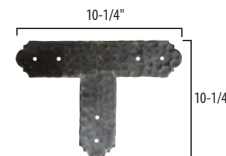



Italian Iron "L" Plate

Item #	Size (Length x Width)	Thickness	Finish	Wt. lbs.	Qty.
#80680	8-1/4" x 8-3/8"	9ga	Bare	1.28 lbs.	10

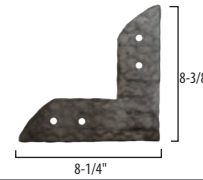

*We strive to offer great products, selection and service at competitive prices.*

Hammered Faux Hinges

Item #	Style	Size (Length x Width)	Finish	Wt. lbs.	Qty.
#80672	(A) Round Iron	18-1/4" x 2-3/8"	Bare	1.90 lbs.	10
#80655	(B) Essex Iron	18-1/4" x 2-3/8"	Bare	1.85 lbs.	10
#80676	(C) Classic Iron	18-3/4" x 3"	Bare	2.14 lbs.	10
#80660	(D) Colonial	18-1/2" x 2-1/2"	Bare	1.43 lbs.	10
#80663	(E) Estate	18-5/8" x 3-7/8"	Bare	1.37 lbs.	10
#80679	(F) Italian	18-1/4" x 2-1/2"	Bare	1.38 lbs.	10

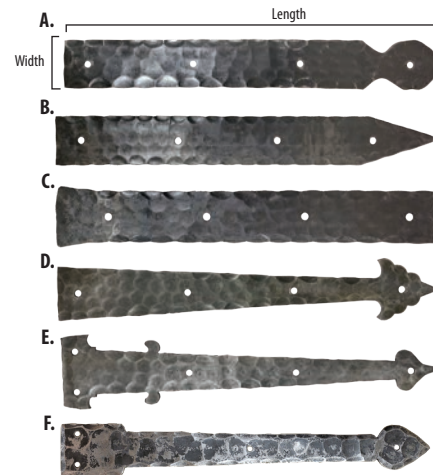

Hammered Hinge Straps

Item #	Style	Size (Length x Width)	Thickness	Finish	Wt. lbs.	Qty.
#80692	(A) Feudal	47-1/2" x 17"	3/16"	Bare	8.43 lbs.	10
#80661	(B) Colonial	22-1/2" x 4-1/2"	3/16"	Bare	2.23 lbs.	15
#80670	(C) Barcelona	22" x 7"	3/16"	Bare	2.06 lbs.	20

*New*  
*New*

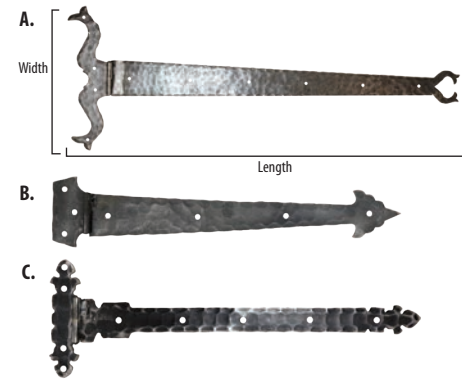

Hammered Hinges

Item #	Style	Size (Length x Width)	Thickness	Finish	Wt. lbs.	Qty.
#80681	(A) Italian	6" x 2-3/4"	3/16"	Bare	0.89 lbs.	10
#80671	(B) Barcelona	6-3/8" x 2-1/2"	3/16"	Bare	0.54 lbs.	50
#80674	(C) Classic Iron	4" x 2"	8ga	Bare	0.21 lbs.	125
#80658	(D) Hammered	5-1/4" x 2-5/8"	3/16"	Bare	0.33 lbs.	100
#80678	(E) Italian Iron	5-1/4" x 4-1/2"	3/16"	Bare	0.36 lbs.	100

*New*  
*New*  
*New*  
*New*

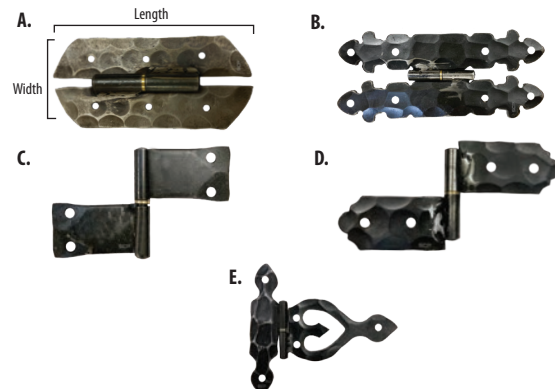

# HARDWARE DECORATIVE ITEMS

## Hammered Hand Rail Bracket

*New*

Item #	Base Size (Length x Width)	Thickness	Finish	Wt. lbs.	Qty.
#80665	4-3/4" x 2-1/2"	1/2"	Bare	2.38 lbs.	15



*New*

## Post Caps

Item #	Style	Size (Fits Over)	Thickness	Finish	Wt. lbs.	Qty.
#80668	(A) Stud	4" x 4"	7ga	Bare	4.66 lbs.	5
#80682	(B) Italian	4" x 4"	3/16"	Bare	1.55 lbs.	10

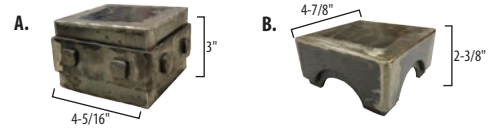

## Straight Flat Strap - 6" Post

Item #	Size (Length x Width)	Thickness	Finish	Wt. lbs.	Qty.
#80666	8-1/2" x 6-1/2"	3/16"	Bare	2.52 lbs.	10

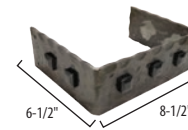

## Flush Base Mount - 3-1/2" Post

Item #	Size (Length x Width)	Thickness	Finish	Wt. lbs.	Qty.
#80657	8" x 3"	3/16"	Bare	2.69 lbs.	10

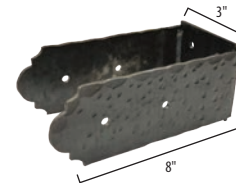

## Hammered Washers

Item #	Style	Size (Length x Width)	Thickness	Finish	Wt. lbs.	Qty.
#80654	(A) Diamond	1-1/4" x 1-1/4"	3/16"	Bare	0.07 lbs.	250
#80662	(B) Colonial	2" x 2"	3/16"	Bare	0.16 lbs.	250
#80673	(C) Square	1-1/4" x 1-1/4"	3/16"	Bare	0.08 lbs.	250



*New*

## Hammered Tack Nails

Item #	Style	Size (Length x Width)	Thickness	Finish	Wt. lbs.	Qty.
#80650	(A) Round Pyramid	1-1/4" x 3/4"	13ga	Bare	0.01 lbs.	1,000
#80651	(B) Square Pyramid	1-1/4" x 3/4"	13ga	Bare	0.02 lbs.	1,000
#80652	(C) Tapered	1" x 1"	1/4"	Bare	0.04 lbs.	1,000

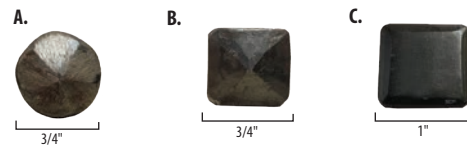

## Garage Decorative Hardware

*New*

Item #	Size (Length x Width)	Thickness	Finish	Wt. lbs.	Qty.
#81571	18" x 2"	1/4"	Powder Coat	2.17 lbs.	15

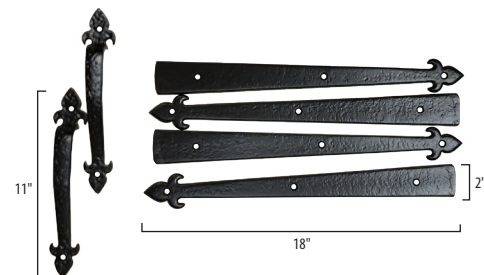

**Cast Iron Strap Hinge - 5" Tee**

Item #	Size (Length x Height)	Thickness	Finish	Wt. lbs.	Qty.
#80817	7" x 4-5/16"	3/16"	Powder Coat	1.49 lbs.	10

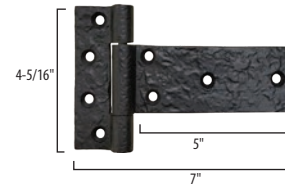

**Cast Iron Flat Hinges**

Item #	Style	Size (Length x Width)	Thickness	Finish	Wt. lbs.	Qty.
#80812	(A) 5"	5-1/4" x 5"	3/16"	Powder Coat	1.63 lbs.	10
#80819	(B) 6"	11-1/4" x 2-3/8"	1/4"	Powder Coat	1.58 lbs.	10

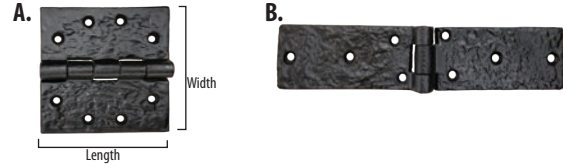

**Cast Iron Strap Hinges**

Item #	Style	Size (Length x Width)	Thickness	Finish	Wt. lbs.	Qty.
#80818	(A) Single	9-1/2" x 4-1/4"	1/4"	Powder Coat	1.27 lbs.	10
#80814	(B) Double	15" x 3-3/4"	1/4"	Powder Coat	1.19 lbs.	10

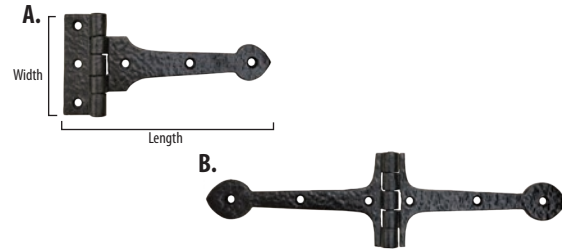

**Decorative H Hinge**

Item #	Size (Length x Width)	Thickness	Finish	Wt. lbs.	Qty.
<i>New</i> #81151	7" x 2-5/8"	1/8"	Powder Coat	0.58 lbs.	10



**Check out these rustic options to spruce up your ranch!**



**Letters And Numbers**  
(page 50)



**Decorative Horseshoes**  
(page 46)

# HARDWARE DECORATIVE HANDLES

## Cast Iron Drop Latch - 7-1/2"

Item #	Finish	Wt. lbs.	Qty.
#80813	Powder Coat	1.27 lbs.	10

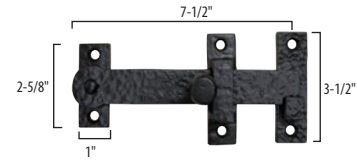

## Cast Iron Ring Latch Kit

Item #	Finish	Wt. lbs.	Qty.
#80820	Powder Coat	3.18 lbs.	10



## Cast Iron Lever Latch Kit

Item #	Finish	Wt. lbs.	Qty.
#80821	Powder Coat	3.61 lbs.	10



## Cast Iron Drop Latch Kit

Item #	Finish	Wt. lbs.	Qty.
#80815	Powder Coat	2.36 lbs.	10

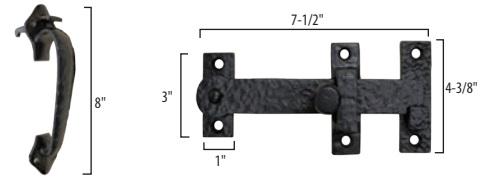

## Cast Iron Drop Latch Kit - Spade

Item #	Finish	Wt. lbs.	Qty.
#80816	Powder Coat	2.18 lbs.	10

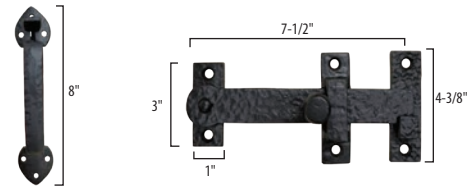

## Cast Iron Handles

Item #	Style	Size (Width X Height)	Finish	Wt. lbs.	Qty.
#80810	(A) Original	1-7/8" x 8"	Powder Coat	0.71 lbs.	10
#80811	(B) Spade	1-3/4" x 8"	Powder Coat	0.62 lbs.	10
#50425	(C) Fleur-De-Lis	2-1/8" x 6-3/4"	Powder Coat	0.45 lbs.	90

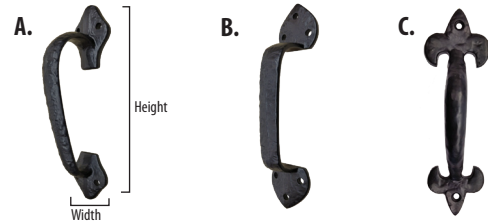

## Cast Iron Decorative Handles

Item #	Size (Length x Width)	Inside Width	Finish	Wt. lbs.	Qty.
#49336	(A) 5-5/8" x 2"	3-5/16"	Bare	0.49 lbs.	10
#49337	(B) 8-3/4" x 2"	5"	Bare	0.84 lbs.	10
#49338	(C) 8-3/4" x 2-3/8"	4-1/2"	Bare	1.16 lbs.	30

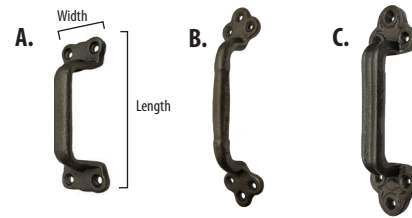

## Decorative Handle

Item #	Size (Length x Width)	Finish	Wt. lbs.	Qty.
<i>New</i> #81590	5-3/4" x 1-1/2"	Powder Coat	0.13 lbs.	200



## Universal Gate Handle 6"

Item #	Type	Finish	Wt. lbs.	Qty.
#48209	Handle	Powder Coat	0.20 lbs.	100
#48208	Complete Set	Powder Coat	5.87 lbs.	8



\*Latches on page 6, hinges on page 20



## 7-1/4" Steel Handle

Item #	Diameter	Size (Length x Height)	Finish	Wt. lbs.	Qty.
#80179	5/8"	7-1/4" x 1-3/4"	Bare	0.63 lbs.	50



## Steel Handle

Item #	Size (Length x Width)	Diameter	Finish	Wt. lbs.	Qty.
#50559	6-1/2" x 2-1/2"	1/2"	Bare	0.45 lbs.	25

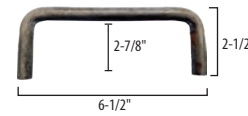

## Spring Steel Handles

Item #	Size (Length x Width)	Threaded	Finish	Wt. lbs.	Qty.
#50504	6" x 3-5/8"	No	Bare	0.75 lbs.	20
#80975	6-1/2" x 4-5/8"	Yes	Bare	1.08 lbs.	20

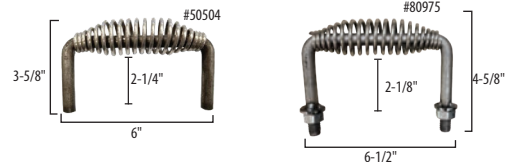

## Spring Handles

Item #	Size	Hole	Style	Wt. lbs.	Qty.
#47691	4-1/2"	3/8"	Zinc	0.23 lbs.	25
#48239	4-1/2"	3/8"	Bare	0.23 lbs.	20
#49838	5"	3/8"	Stainless	0.29 lbs.	20
#80388	5"	5/8"	Stainless	0.34 lbs.	20
#49450	6"	1/2"	Zinc	0.33 lbs.	20
#49198	6"	5/8"	Bare	0.55 lbs.	20
#49805	6"	1/2"	Stainless	0.33 lbs.	20

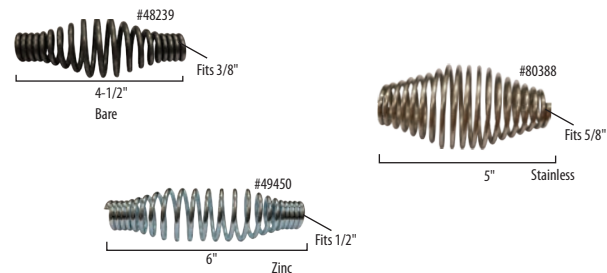

*If you need help with an order, have questions about our products, or have an inquiry about setting up an account, please contact a member of our team today!*

*We would love to hear from you!  
1-866-651-6702 or [sales@springcreekproducts.com](mailto:sales@springcreekproducts.com)*

## Wall Handles

Item #	Size (Length x Width)	Finish	Wt. lbs.	Qty.
#49103	(A) 6-3/4" x 1-5/16"	HDG	0.17 lbs.	10
#49428	(B) 13-1/4" x 3/4"	Chrome	0.74 lbs.	10

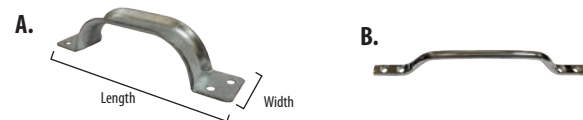

## Chest Handle With Rubber Grip

Item #	Size	Plate Size (Length x Width)	Finish	Wt. lbs.	Qty.
#50302	4"	3-3/8" x 1-7/8"	Zinc	0.35 lbs.	100

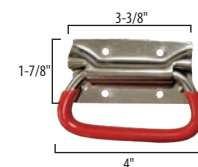

## Chest Handles

Item #	Plate Size (Length x Width)	Finish	Wt. lbs.	Qty.
#49432	(A) 3-3/8" x 1-3/4"	Zinc	0.29 lbs.	10
#50416	(B) 4-1/8" x 2-7/8"	Zinc	0.31 lbs.	100



## Cast Iron Braces

Item #	Style	Base Size (Length x Width)	Finish	Wt. lbs.	Qty.
#50437	(A) Cross	6-5/8" x 4-7/8"	Bare	0.74 lbs.	40
#50438	(B) Star - Small	7-3/4" x 7-3/4"	Bare	1.35 lbs.	10
#50439	(C) Star - Medium	8-1/2" x 6-3/8"	Bare	1.55 lbs.	20
#80799	(D) Curves	8-1/4" x 9"	Bare	1.49 lbs.	20
<i>New</i> #81685	(E) Curls	7-5/8" x 7-1/4"	Bare	1.52 lbs.	20
<i>New</i> #81686	(F) White Rustic	7-5/8" x 7-1/4"	White	1.54 lbs.	20

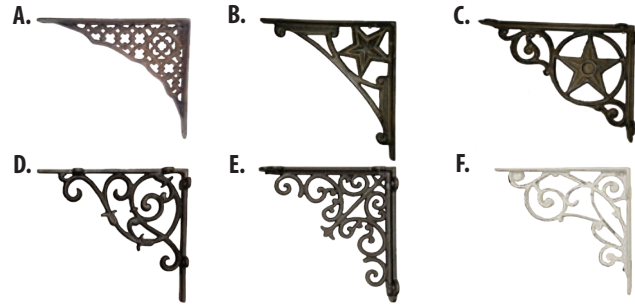

## Steel Shelf Bracket

Item #	Base Size (Length x Width)	Thickness	Finish	Wt. lbs.	Qty.
#50443	8-1/4" X 5-1/4"	1/8"	Powder Coat	0.45 lbs.	10



*New*

## Corner Braces - Square

Item #	Base Size (Length x Width)	Thickness	Finish	Wt. lbs.	Qty.
#81572	3-1/8" x 1-1/2"	1/8"	Powder Coat	0.29 lbs.	120
#81573	6-1/4" x 1-1/2"	1/4"	Powder Coat	1.18 lbs.	30
#81574	8-1/4" x 8-1/4"	1/4"	Powder Coat	1.61 lbs.	20
#81578	1-5/8" x 3"	1/8"	Powder Coat	0.29 lbs.	120

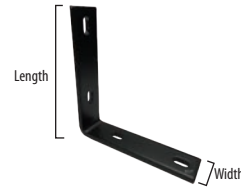

*New*

## Corner Braces - Cut Corners

Item #	Base Size (Length x Width)	Thickness	Finish	Wt. lbs.	Qty.
#81575	5" x 3"	1/8"	Powder Coat	0.94 lbs.	35
#81576	2-3/8" x 3"	1/8"	Powder Coat	0.04 lbs.	80

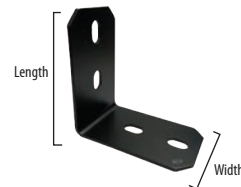

## Corner Braces - Unequal

Item #	Base Size (Length x Width x Height)	Thickness	Finish	Wt. lbs.	Qty.
<i>New</i> #81577	3-1/2" x 1-1/2" x 1-5/8"	1/8"	Powder Coat	0.24 lbs.	140

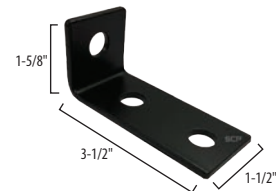

*New*

## Corner Braces - Square

Item #	Base Size (Length x Width)	Thickness	Qty In Pack	Finish	Wt. lbs.	Qty.
#81580	1" x 1/2"	1/8"	4	Zinc	0.10 lbs.	200
#81581	1-1/2" x 11/16"	1/8"	4	Zinc	0.19 lbs.	160
#81582	2" x 3/4"	1/8"	4	Zinc	0.24 lbs.	120
#81583	3" x 3/4"	1/8"	4	Zinc	0.51 lbs.	60
#81584	2" x 1-1/2"	1/8"	2	Zinc	0.34 lbs.	100
#81585	2-1/2" x 1-1/2"	1/8"	2	Zinc	0.27 lbs.	120

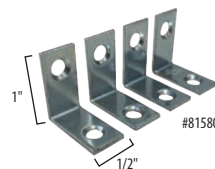

**Mending Plate**

Item #	Size (Length x Width)	Thickness	Finish	Wt. lbs.	Qty.
<i>New</i> #81579	6" x 1-1/2"	1/8"	Powder Coat	0.31 lbs.	120

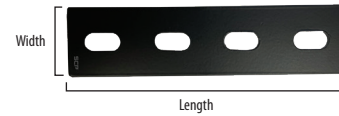

*New*

**Mending Plates**

Item #	Size (Length x Width)	Thickness	Qty In Pack	Finish	Wt. lbs.	Qty.
#81586	2" x 1/2"	1/8"	4	Zinc	0.10 lbs.	200
#81587	8" x 7/8"	1/8"	1	Zinc	0.22 lbs.	120

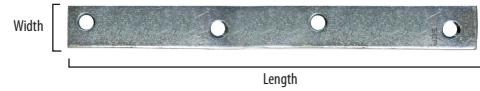

**Coat Hook - Swivel**

Item #	Base Size (Length x Width)	Finish	Wt. lbs.	Qty.
#50436	5-5/16" x 2-3/16"	Bare	0.85 lbs.	50



**Coat Hooks**

Item #	Size	Length	Height	Finish	Wt. lbs.	Qty.
#49333	(A) Small	3-1/8"	2-5/16"	Bare	0.19 lbs.	10
#49334	(B) Medium	3"	3"	Bare	0.28 lbs.	10
#49335	(C) Large	3-3/4"	4-3/8"	Bare	0.33 lbs.	10
#50435	(D) XL	7-1/2"	4"	Bare	0.90 lbs.	50

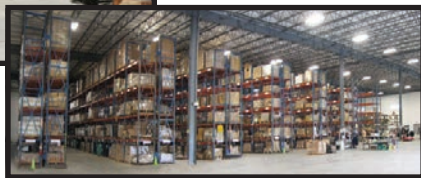
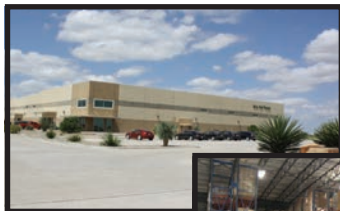
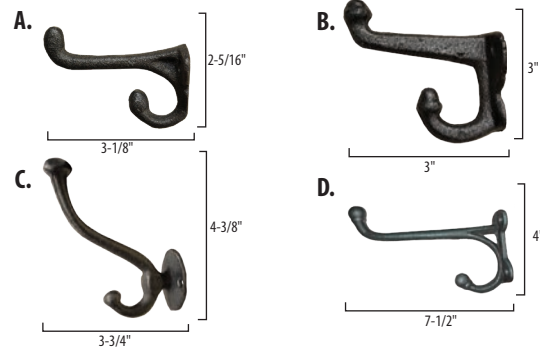

*Shipping throughout the U.S.A.*

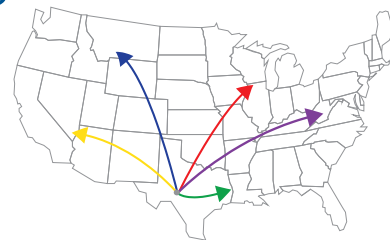

**Decorative Horseshoes - Cast Steel**

Item #	Size	Width	Height	Finish	Wt. lbs.	Qty.
#49339	S	2-7/8"	3-3/8"	Bare	0.21 lbs.	10
#49340	M	4"	4-1/4"	Bare	0.38 lbs.	10
#49341	L	4-1/2"	4-1/2"	Bare	0.54 lbs.	10
#49342	XL	6"	6-3/4"	Bare	0.91 lbs.	10

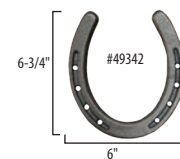

\*\*THESE ARE FOR DECORATIVE USE ONLY. DO NOT USE ON HORSES. \*\*

**Decorative Horseshoes - Forged Steel**

Item #	Size	Width	Height	Finish	Wt. lbs.	Qty.
#50428	Pony	3-1/4"	3-3/4"	Bare	0.37 lbs.	80
#80445	Pony	3-1/4"	3-3/4"	Zinc	0.37 lbs.	80



\*\*THESE ARE FOR DECORATIVE USE ONLY. DO NOT USE ON HORSES. \*\*

# HARDWARE DECORATIVE ITEMS

## Texas Star Pins - Cast Iron

Item #	Size	Width	Finish	Wt. lbs.	Qty.
#50622	Mini	1-13/16"	Bare	0.01 lbs.	25
#50641	S	2-11/16"	Bare	0.01 lbs.	25
#50642	M	3-1/4"	Bare	0.18 lbs.	25
#50643	L	5"	Bare	0.50 lbs.	25

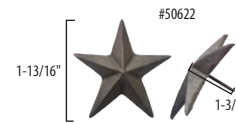

## Steel Stars

Item #	Size (Length x Width)	Finish	Wt. lbs.	Qty.
#81069	4"	Bare	0.29 lbs.	50
#81070	4-1/2"	Bare	0.35 lbs.	50
#46141	6"	Powder Coat	0.53 lbs.	50



*Retailer, Wholesaler, or Manufacturer,  
We've got you covered!  
Call us today to set up an account!  
1-866-651-6702*

## Bottle Openers

Item #	Size (Height x Width)	Finish	Wt. lbs.	Qty.
#49969	3-1/4" x 2-1/2"	Cast Iron	0.32 lbs.	100
#50026	3-3/16" x 2-1/2"	Nickel-plated	0.16 lbs.	100

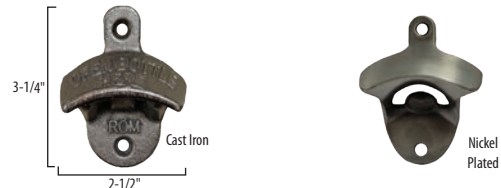

## Bottle Cap Catcher

Item #	Finish	Wt. lbs.	Qty.
#50333	Stainless Steel	0.23 lbs.	10



## Bottle Cap Catcher And Opener Kit

Item #	Finish	Wt. lbs.	Qty.
#50548	Stainless Steel	0.45 lbs.	75

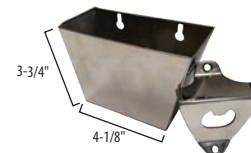

## Decorative Tractor Seat

Item #	Width	Height	Thickness	Finish	Wt. lbs.	Qty.
#49843	17-1/2"	13-1/2"	14ga	Bare	4.65 lbs.	10

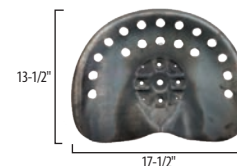

## Tractor Seat Bar Stool Weld Kit

Item #	Height	Seat Size	Steel Base	Wt. lbs.	Qty.
#50680	27"-31"	18"	20"	34.00 lbs.	1

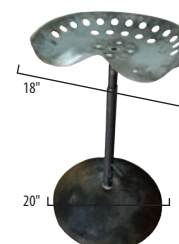





## Letters & Numbers Display

Our letters and numbers display is a perfect addition for your showroom!

We have a variety of styles and sizes to satisfy your customers and their projects.

See all items on page 50.

Contact a sales representative today for more details.

### Tubular Handrail

Item #	Size (Width x Length)	Thickness	Finish	Wt. lbs.	Qty.
#50789	1-5/8" x 8'	14ga	Bare	9.84 lbs.	1

This item does not qualify for free freight

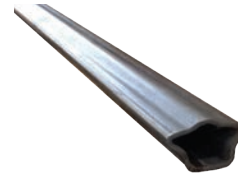

### Rail Clips

Item #	Type	Width	Thickness	Finish	Wt. lbs.	Qty.
#48452	Flat Tab	2-3/4"	9ga	Bare	0.50 lbs.	10 / box 2,000 / drum
#49821	Bent Tab	2-3/4"	9ga	Bare	0.50 lbs.	100 / box 2,000 / drum

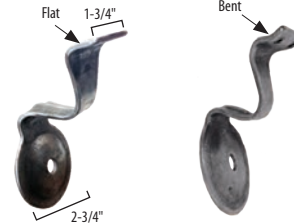

### Bolt On Rail Flanges

Item #	Size (Pipe fits)	Finish	Wt. lbs.	Qty.
#49807	1.25" O.D.	Bare	0.26 lbs.	50
#49806	1.75" O.D.	Bare	0.34 lbs.	100
#49732	1.90" O.D.	Bare	0.43 lbs.	50

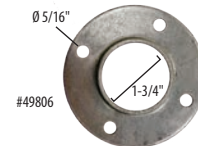

### Handrail End Caps - Cast Iron

Item #	Cast Iron Type	Size (Width x Length)	Finish	Wt. lbs.	Qty.
#80639	(A) Straight	2-5/8" x 4-1/8"	Bare	1.14 lbs.	20
#80640	(B) Beveled	3-5/8" x 3-3/4"	Bare	0.85 lbs.	20
#80641	(C) Volute	3" x 2-1/4"	Bare	1.49 lbs.	20
#80642	(D) Cap	2-1/8" x 1-5/8"	Bare	0.49 lbs.	20
#80643	(E) Flange	2-3/16" x 3-11/16"	Bare	0.49 lbs.	20

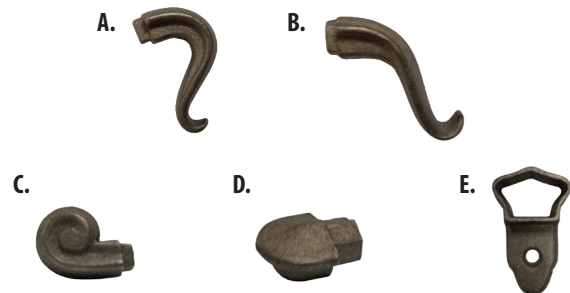

**Cowboy Cross Welcome Sign**

Item #	Size (Length x Width)	Thickness	Finish	Wt. lbs.	Qty.
#46149	34" x 24"	11ga	Powder Coat	9.69 lbs.	1

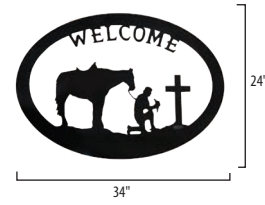

**Welcome Sign Metal Art**

Item #	Size (Length x Width)	Thickness	Finish	Wt. lbs.	Qty.
#46155	30-1/2" x 7"	11ga	Powder Coat	2.13 lbs.	10



**Rooster Metal Art**

Item #	Size (Length x Width)	Thickness	Finish	Wt. lbs.	Qty.
<i>New</i> #81697	15" x 14"	11ga	Powder Coat	2.63 lbs.	1

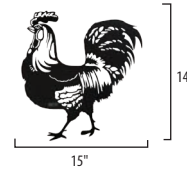

**Triple Horse Head Metal Art**

Item #	Size (Length x Width)	Thickness	Finish	Wt. lbs.	Qty.
<i>New</i> #46393	45-3/4" x 33-1/4"	11ga	Powder Coat	11.5 lbs.	1

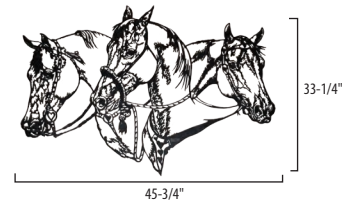

**Horse Head Metal Art**

Item #	Size (Length x Width)	Thickness	Finish	Wt. lbs.	Qty.
<i>New</i> #81698	18" x 17"	11ga	Powder Coat	3.13 lbs.	1

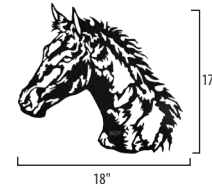

**Texas Metal Art**

Item #	Size (Length x Width)	Thickness	Finish	Wt. lbs.	Qty.
<i>New</i> #81699	17-1/2" x 18"	11ga	Powder Coat	4.28 lbs.	1

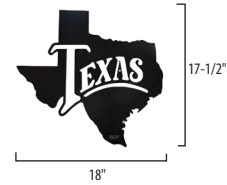

**No Trespassing Sign**

Item #	Size (Length x Width)	Thickness	Finish	Wt. lbs.	Qty.
#46119	20" x 15"	11ga	Powder Coat	6.31 lbs.	10

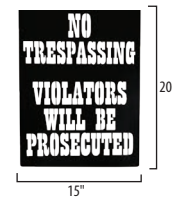

**No Hunting Sign**

Item #	Size (Length x Width)	Thickness	Finish	Wt. lbs.	Qty.
#46118	10" x 15"	11ga	Powder Coat	3.37 lbs.	1





## Letters And Numbers



### Western Letters And Numbers - 4" Weld On

P

8

'A' - #46168	'J' - #46177	'S' - #46190	'1' - #46159
'B' - #46169	'K' - #46178	'T' - #46191	'2' - #46160
'C' - #46170	'L' - #46179	'U' - #46192	'3' - #46161
'D' - #46171	'M' - #46180	'V' - #46194	'4' - #46162
'E' - #46172	'N' - #46181	'W' - #46195	'5' - #46163
'F' - #46173	'O' - #46158	'X' - #46196	'6' - #46164
'G' - #46174	'P' - #46183	'Y' - #46198	'7' - #46165
'H' - #46175	'Q' - #46184	'Z' - #46199	'8' - #46166
'I' - #46176	'R' - #46189		'9' - #46164
			'0' - #46158

### Western Letters And Numbers - 4" Bolt On

A

2

#

'A' - #50470	'J' - #50479	'S' - #50488	'1' - #50496	'#' - #50512
'B' - #50471	'K' - #50480	'T' - #50489	'2' - #50497	'!' - #50527
'C' - #50472	'L' - #50481	'U' - #50490	'3' - #50498	'The' - #50514
'D' - #50473	'M' - #50482	'V' - #50491	'4' - #50499	'and' - #50513
'E' - #50474	'N' - #50483	'W' - #50492	'5' - #50500	<small>(Symbols are not 4" tall)</small>
'F' - #50475	'O' - #50484	'X' - #50493	'6' - #50501	
'G' - #50476	'P' - #50485	'Y' - #50494	'7' - #50502	
'H' - #50477	'Q' - #50486	'Z' - #50495	'8' - #50503	
'I' - #50478	'R' - #50487		'9' - #50528	
			'0' - #50529	

### Standard Letters And Numbers - 8" Weld On

H

7

@

'A' - #81003	'J' - #81012	'S' - #81021	'1' - #81030	'#' - #81041
'B' - #81004	'K' - #81013	'T' - #81022	'2' - #81031	'&' - #81040
'C' - #81005	'L' - #81014	'U' - #81023	'3' - #81032	'!' - #81039
'D' - #81006	'M' - #81015	'V' - #81024	'4' - #81033	'@' - #81042
'E' - #81007	'N' - #81016	'W' - #81025	'5' - #81034	'." - #81043
'F' - #81008	'O' - #81017	'X' - #81026	'6' - #81035	<small>(Symbols are not 8" tall)</small>
'G' - #81009	'P' - #81018	'Y' - #81027	'7' - #81036	
'H' - #81010	'Q' - #81019	'Z' - #81028	'8' - #81037	
'I' - #81011	'R' - #81020		'9' - #81038	
			'0' - #81029	



# HORSE STALL CHANNELS

CREATE YOUR OWN SPECIAL LOOK FOR A FRACTION OF THE PRICE OF  
PREBUILT STALLS AND DOORS!

These channels can be easily attached to wood or steel posts using self drilling screws.  
Wood planks slide in between the channels and can be easily added or removed  
to adjust your barrier height.



Channel Bracket  
#81065

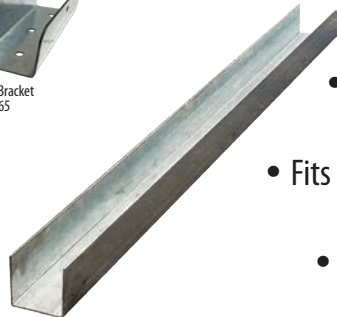

Full Length Channel

- Suits 2" wooden planks any height (4", 6", 8", etc.)
- Fits perfectly into these inexpensive channels
  - Comes in 6', 8', 10', or 12' lengths
  - Available in bare or galvanized finish

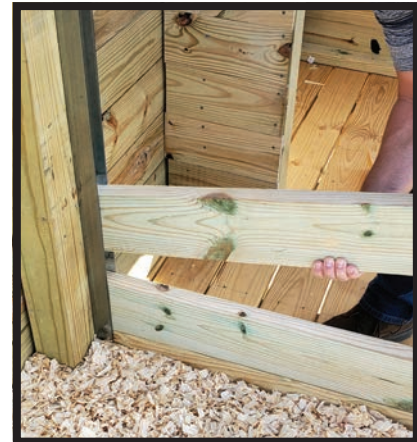

## Horse Stall Channels

Sturdy formed steel channel, 1-5/8" long on all three sides. Can be bolted or welded to most surfaces such as wood, steel, or concrete.

### Galvanized

*New*

Item #	Length	Thickness	Wt. lbs.	Qty.
#81065	5"	16ga	0.34 lbs	50
#80976	6'	16ga	6.00 lbs.	1
#50535	8'	16ga	8.00 lbs.	1
#50536	10'	16ga	10.00 lbs.	1
#80459	10'	14ga	12.96 lbs.	1
#50537	12'	16ga	12.00 lbs.	1

### Bare

Item #	Length	Thickness	Wt. lbs.	Qty.
#81537	6'	16ga	6.00 lbs.	1
#80454	8'	16ga	8.00 lbs.	1
#80455	10'	16ga	10.00 lbs.	1
#80456	12'	16ga	12.00 lbs.	1

These items do not qualify for free freight





## Hay Bale Spears



### Loop and Pin Style - Set

Item #	Type	Finish	Wt. lbs.	Qty.
#49811	Spear and Sleeve Set - 39"	Painted	21.50 lbs.	1
#49809	Spear and Sleeve Set - 48"	Painted	26.94 lbs.	1

### Replacement Pieces

Item #	Type	Finish	Wt. lbs.	Qty.
#50111	Sleeve Only	Zinc	3.30 lbs.	1
#49858	Linchpin - 3/8" x 2-1/2"	Zinc	0.14 lbs.	1



### Tapered Sleeve and Nut Style

Item #	Type	Finish	Wt. lbs.	Qty.
#49812	Spear and Sleeve Set - 39"	Painted	21.50 lbs.	1
#49810	Spear and Sleeve Set - 48"	Painted	26.94 lbs.	1

### Replacement Pieces

Item #	Type	Finish	Wt. lbs.	Qty.
#50112	Sleeve Only	Zinc	3.30 lbs.	1
#81045	Threaded Nut	Bare	0.31 lbs.	1

**\*\*Bale Spears are guaranteed for 1 year from date of purchase. Only for moving hay bales.**

## Bale Spear Bracket

Item #	Plate Size (Length x Height)	Finish	Wt. lbs.	Qty.
#49813	4-7/8" x 7-7/8"	Powder Coat	11.58 lbs.	1



## Ground Anchor Spiral

Item #	Size (Diameter x Length)	Finish	Wt. lbs.	Qty.
#50461	3/8" x 10"	Powder Coat	1.38 lbs.	25

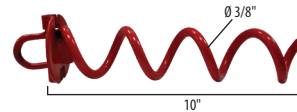

## Landscape Stake

Item #	Size	Finish	Wt. lbs.	Qty.
#47667	1/4" x 1"	Bare	0.60 lbs.	1,500



## Landscape Edge

Item #	Size (Length x Width x Height)	Finish	Wt. lbs.	Qty.
#47021	10' x 1/8" x 3-7/8"	Powder Coat	17.00 lbs.	100

This item does not qualify for free freight



## Tree Stake Kit

Item #	Stakes	Wire	Finish	Wt. lbs.	Qty.
#50182	5/8" x 24"	1/8" x 8"	Bare	6.30 lbs.	5

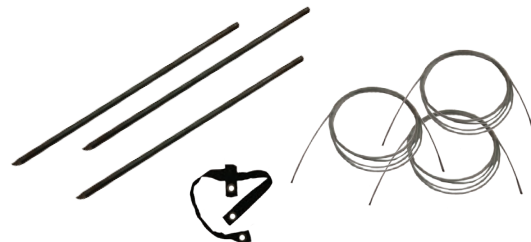

# FARM AND RANCH RANCH ACCESSORIES

## Freeze Miser®

Item #	Wt. lbs.	Qty.
#80974	0.29 lbs.	16



## Propane Gas Torch

Item #	Wt. lbs.	Qty.
#50146	3.00 lbs.	10

PROPANE TANK NOT INCLUDED



## Steel Plate Targets

Item #	Size	Thickness	Finish	Wt. lbs.	Qty.
#80403	6"	3/8"	Zinc	3.06 lbs.	1
#80404	8"		Zinc	5.44 lbs.	1
#80405	10"		Zinc	8.50 lbs.	1
#80406	6"	1/2"	Zinc	3.69 lbs.	1
#80407	8"		Zinc	6.51 lbs.	1
#80408	10"		Zinc	10.19 lbs.	1



*New*

## AR500 Steel Targets

Item #	Size	Thickness	Finish	Wt. lbs.	Qty.
#81625	6"	3/8"	Powder Coat	3.19 lbs.	10
#81626	8"		Powder Coat	5.70 lbs.	5
#81627	10"		Powder Coat	8.82 lbs.	5
#81628	6"	1/2"	Powder Coat	3.80 lbs.	10
#81629	8"		Powder Coat	6.75 lbs.	5
#81630	10"		Powder Coat	10.50 lbs.	5



## Target Holder Set

Item #	Pipe Size	Finish	Wt. lbs.	Qty.
#80989	1-1/4"	Powder Coat	2.09 lbs.	20



## Rain Gauge

Item #	Size (Length x Width x Depth)	Material	Wt. lbs.	Qty.
#81075	12-1/2" x 2-3/4" x 2-7/8"	Plastic	0.24 lbs.	20

*New*



**Specialty Metal Art Cookers**

Item #	Type	Thickness	Finish	Wt. lbs.	Qty.
#46065	(A) Chicken Cooker	3/16"	Bare	2.75 lbs.	1
#46116	(B) Jalapeno Cooker	7ga	Bare	4.56 lbs.	1

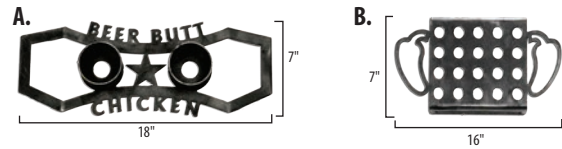

**10" Shoe Handle Wire Brush**

Item #	Type	Row Pattern	Wt. lbs.	Qty.
#70039	Carbon	4 x 16	0.29 lbs.	12



**13" Wooden Handle Angled Wire Brush**

Item #	Type	Row Pattern	Wt. lbs.	Qty.
#70272	Carbon	3 x 14	0.38 lbs.	12



**14" Wooden Handle Wire Brushes**

Item #	Type	Row Pattern	Wt. lbs.	Qty.
#70038	Carbon	3 x 19	0.33 lbs.	15
#70040	Stainless Steel	3 x 19	0.25 lbs.	12



**Sign Up To Order Online!**



It's simple and easy! Place orders, view product information, prices, and invoices.

Contact your sales representative for more information at 866-651-6702

**Check out the website: [www.springcreekproducts.com](http://www.springcreekproducts.com)**

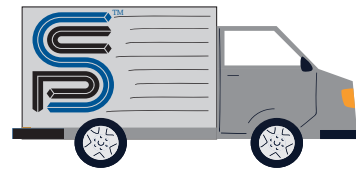

*New*

**Grilling Utensils**

Item #	Style	Size (Length x Width)	Finish	Wt. lbs.	Qty.
#81055	(A) Fork - Small	17-1/2" x 1-1/2"	Bare	0.48 lbs.	70
#81056	(A) Fork - Large	27" x 2"	Bare	1.18 lbs.	30
#81057	(B) Spatula	17-7/8" x 3-1/2"	Bare	1.68 lbs.	50
#81061	(C) Spatula Combo	19-3/4" x 3-1/2"	Bare	1.22 lbs.	30
#81060	(D) Tongs	16-1/2" x 2"	Bare	0.88 lbs.	40
#81058	(E) Fire Poker - Small	33" x 4"	Bare	2.25 lbs.	20
#81059	(E) Fire Poker - Large	38-3/4" x 3-3/4"	Bare	2.67 lbs.	10

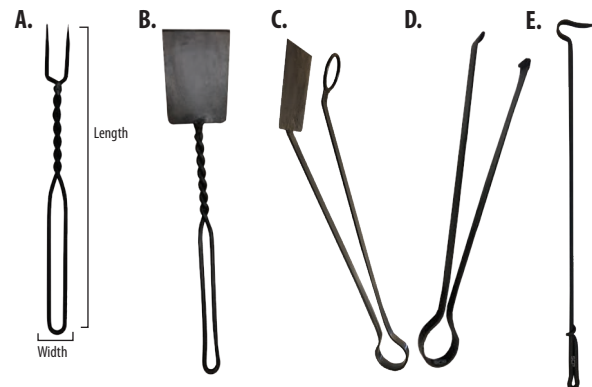

# FARM AND RANCH FIRE PITS AND GRILLS

## Fire Pit Cooking Grate

Item #	Size	Finish	Wt. lbs.	Qty.
#80686	40" x 24-3/8"	Bare	17.20 lbs.	1

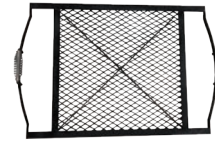

## Tank Head - Dished

Item #	Size	Finish	Wt. lbs.	Qty.
#80000	20" x 3/16"	Bare	23.00 lbs.	1

This item does not qualify for free freight



## Texas Bird Bath Weld Kit

Item #	Height	Grill Size	Steel Base	Finish	Wt. lbs.	Qty.
#49385	26"-32"	20"	20"	Bare	60.00 lbs.	1

This item does not qualify for free freight



## 3-in-1 Fire Pit Weld Kit

Item #	Height	Grill Size	Finish	Wt. lbs.	Qty.
#49384	16"	20"	Bare	60.00 lbs.	1

This item does not qualify for free freight



## Portable Fire Bowl

Item #	Size	Finish	Wt. lbs.	Qty.
#80980	24" x 12"	Bare	18.00 lbs.	1

This item does not qualify for free freight



## Fire Pit Bowls

Item #	Diameter x Depth	Thickness	Finish	Wt. lbs.	Qty.
#80232	31-3/4" x 9"	3/16"	Bare	66.67 lbs.	1
#80806	23-3/4" x 6-3/4"	3/16"	Bare	41.07 lbs.	1
#80807	35-1/2" x 10"	3/16"	Bare	81.04 lbs.	1
#80808	43-3/4" x 12"	3/16"	Bare	119.90 lbs.	1

These items do not qualify for free freight



## Fire Pit Kits - Bolt Together

Item #	Style	Grill Size	Wt. lbs.	Qty.
#50414	Star	48"	112.00 lbs.	1
#50415	Horse	48"	112.00 lbs.	1
#80100	Cowboy	48"	112.00 lbs.	1

These items do not qualify for free freight

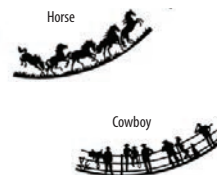

Star



## 1/2" Threaded Coupling

Item #	Size (Width x Height)	Fits	Finish	Weight	Qty.
#80194	1" x 1-1/2"	#48613 #49491 #48614	Bare	0.18 lbs.	240



## BBQ Pit Thermometers

Item #	Size	Stem	Wt. lbs.	Qty.
#48612	2"	2-1/2"	0.12 lbs.	1
#48613	3"	2-1/2"	0.34 lbs.	1
#49491	3"	5"	0.35 lbs.	1
#48614	4"	2-1/2"	0.55 lbs.	1



## Ball Valve

Item #	Size	Style	Finish	Wt. lbs.	Qty.
#50263	1-1/4"	Female / Female	Brass	1.75 lbs.	4

THIS ITEM IS NOT APPROVED FOR ANY OTHER APPLICATIONS, BESIDES SMOKERS



## Solid Steel Ball

Item #	Size	Finish	Wt. lbs.	Qty.
#81053	1"	Bare	0.15 lbs.	100



## BBQ Vents

Item #	Size	Center Hole	Finish	Wt. lbs.	Qty.
#80981	4" x 11ga	1/4"	Bare	0.24 lbs.	10
#80982	6" x 11ga	3/8"	Bare	0.55 bs.	10
#80983	8" x 11ga	3/8"	Bare	0.98 lbs.	10

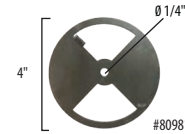

## Steel Handle

Item #	Size (Length x Width)	Rod Diameter	Finish	Wt. lbs.	Qty.
#50559	6-1/2" x 2-1/2"	1/2"	Bare	0.45 lbs.	25

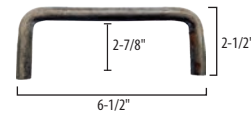

## Spring Steel Handles

Item #	Size (Length x Width)	Threaded	Finish	Wt. lbs.	Qty.
#50504	6" x 3-5/8"	No	Bare	0.75 lbs.	20
#80975	6-1/2" x 4-5/8"	Yes	Bare	1.08 lbs.	20

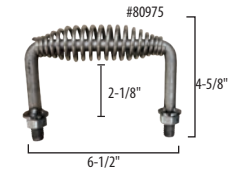
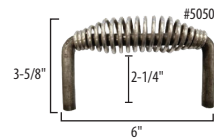

## Spring Handles

Item #	Size	Hole	Style	Wt. lbs.	Qty.
#47691	4-1/2"	3/8"	Zinc	0.23 lbs.	25
#48239	4-1/2"	3/8"	Bare	0.23 lbs.	20
#49838	5"	3/8"	Stainless	0.29 lbs.	20
#80388	5"	5/8"	Stainless	0.34 lbs.	20
#49450	6"	1/2"	Zinc	0.33 lbs.	20
#49198	6"	5/8"	Bare	0.55 lbs.	20
#49805	6"	1/2"	Stainless	0.33 lbs.	20

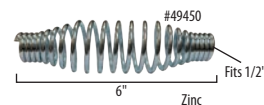
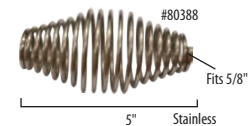
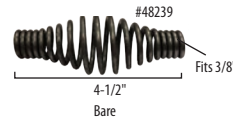

## Cast Iron BBQ Wheels And Mounting Kit

Item #	Wheel Size (Diameter x Width)	Finish	Wt. lbs.	Qty.
#49503	4" x 1-1/4"	Bare	1.38 lbs.	10
#49504	5" x 1-1/4"	Bare	1.79 lbs.	10
#50400	Kit	Bare	1.05 lbs.	10 (Wheel Not Included)



# TRAILER PARTS TRAILER LIGHTS

*New*

## Round Clearance & Marker Lights - 3 LED

Item #	Size	Lens / Light	Grommet	End Type	Wt. lbs.	Qty.
#81374	3/4"	Amber / Amber	Yes	Bare	0.01 lbs.	200
#81376	3/4"	Amber / Amber	Yes / Large	Bare	0.01 lbs.	200
#81615	3/4"	Amber / Amber	Yes	Bullet	0.03 lbs.	200
#81494	3/4"	Clear / Amber	Yes	Bare	0.01 lbs.	1,000
#81491	3/4"	Clear / Amber	Yes	Bullet	0.04 lbs.	1,000
#81493	3/4"	Clear / Red	Yes	Bare	0.01 lbs.	1,000
#81492	3/4"	Clear / Red	Yes	Bullet	0.04 lbs.	1,000
#81375	3/4"	Red / Red	Yes	Bare	0.01 lbs.	200
#81377	3/4"	Red / Red	Yes / Large	Bare	0.01 lbs.	200
#81616	3/4"	Red / Red	Yes	Bullet	0.03 lbs.	200
<hr/>						
#81380	2"	Clear / Amber	Yes	Plug	0.11 lbs.	200
#81381	2"	Clear / Red	Yes	Plug	0.12 lbs.	200
#81612	2"	Dark Amber / Amber	Yes	No	0.10 lbs.	1
#81378	2"	Dark Amber / Amber	Yes	Plug	0.11 lbs.	250
#81613	2"	Dark Red / Red	Yes	No	0.10 lbs.	1
#81379	2"	Dark Red / Red	Yes	Plug	0.12 lbs.	250
<hr/>						
#81382	2-1/2"	Amber / Amber	Yes	Plug	0.14 lbs.	200
#81482	2-1/2"	Dark Red / Red	Yes	Plug	0.14 lbs.	200



## Round Marker Light - LED

Item #	Size	Lens / Light	Grommet	End Type	Wt. lbs.	Qty.
#80370	2"	Red / Red	Yes	Bare	0.19 lbs.	12



**URIAH**

*New*

## Rectangular Clearance & Marker Lights - 12 LED

Item #	Size	Lens / Light / Mount	Grommet	End Type	Wt. lbs.	Qty.
#81481	4" x 1"	Amber / Amber / Black	No	Bare	0.13 lbs.	100
#81383	4" x 1"	Red / Red / Black	No	Bare	0.13 lbs.	100



*New*

## Square Clearance & Marker Lights - 3 LED

Item #	Size	Lens / Light	Grommet	End Type	Wt. lbs.	Qty.
#81423	2" x 2"	Amber / Amber	No	Bare	0.11 lbs.	200
#81446	2" x 2"	Red / Red	No	Bare	0.10 lbs.	200



*New*

## Oval Clearance & Marker Lights - 3 LED

Item #	Size	Lens / Light	Grommet	End Type	Wt. lbs.	Qty.
#81445	2.6" x 1"	Amber / Amber	Chrome Bezel	Bare	0.07 lbs.	400
#81384	4" x 2"	Red / Red	Yes	Bare	0.11 lbs.	200



*New*

**Square Stop / Turn / Tail / License Lights - 11 LED**

Item #	Size	Lens / Light	Grommet	End Type	Wt. lbs.	Qty.
#81386	4" - Left	Red / Red - Under 80"	No	Bare	0.57 lbs.	40
#81387	4" - Right	Red / Red - Under 80"	No	Bare	0.57 lbs.	40
#81388	4" - Left	Red / Red - Over 80"	No	Bare	0.70 lbs.	40
#81389	4" - Right	Red / Red - Over 80"	No	Bare	0.70 lbs.	40



**Square Stop / Turn / Tail / License Light - LED**

Item #	Type	Lens / Light	Grommet	End Type	Wt. lbs.	Qty.
#80358	Streetside	Clear / White	No	Bare	0.75 lbs.	6



**Square Stop / Turn / Tail / License Light**

Item #	Size	Lens / Light	Grommet	End Type	Wt. lbs.	Qty.
#80310	4-1/2" - Left	Red / Red	No	Bare	0.50 lbs.	6



**Round Stop / Turn / Tail Light - 12 LED**

Item #	Size	Lens / Light	Grommet	End Type	Wt. lbs.	Qty.
#81385	4"	Dark Red / Red	Yes	Plug	0.41 lbs.	72

*New*



**Round Stop / Turn / Tail Light**

Item #	Size	Lens / Light	Grommet	End Type	Wt. lbs.	Qty.
#80313	4"	Red / Red	Yes	Plug	0.47 lbs.	6



**\$1,000+ Orders Ship For Free!!!**



**Call your sales representative  
today to see if you qualify!  
1-866-651-6702**

*Some exclusions apply, offer subject to change without notice.*

*New*

**Oval Stop / Turn / Tail Lights - 10 LED**

Item #	Size	Lens / Light	Grommet	End Type	Wt. lbs.	Qty.
#81391	6" x 2"	Clear / Red	Yes	Plug	0.43 lbs.	60
#81501	6" x 2"	Dark Red / Red	Yes	No	0.39 lbs.	60
#81390	6" x 2"	Dark Red / Red	Yes	Plug	0.42 lbs.	60
#81392	6" x 2"	Dark Red / Red	Yes - Chrome	Plug	0.33 lbs.	80
#81677	6" x 2"	Dark Red / Red	Yes	HW	0.36 lbs.	80



**Oval Stop / Turn / Tail Light - 10 LED**

Item #	Size	Lens / Light	Grommet	End Type	Wt. lbs.	Qty.
#80355	6-1/2" x 2-1/4"	Red / Red	Yes	Bare	0.34 lbs.	6



*New*

**Ship / Turn / Marker Lights - 9 LED**

Item #	Size	Lens / Light	Grommet	End Type	Wt. lbs.	Qty.
#81700	6"	Clear / Amber	Yes	Plug	0.41 lbs.	80
#81457	6"	Amber / Amber	Yes	Plug	0.40 lbs.	80
#81642	6"	Amber / Amber	Yes	No	0.36 lbs.	40



*New*

**Stop / Turn / Tail Light Bars - 11 LED**

Item #	Size	Lens / Light	Grommet	End Type	Wt. lbs.	Qty.
#81395	16"	Red / Red	N/A	Bare	0.28 lbs.	100
#81394	17"	Red / Red	N/A	Bare	0.38 lbs.	50



#81394

*New*

**Oval Back Up Lights - 10 LED**

Item #	Size	Lens / Light	Grommet	End Type	Wt. lbs.	Qty.
#81443	6" x 2"	Clear / White	Yes	Plug	0.43 lbs.	60
#81619	6" x 2"	Clear / White	Yes	No	0.40 lbs.	60



**Round Back Up Light - 12 LED**

Item #	Size	Lens / Light	Grommet	End Type	Wt. lbs.	Qty.
#81618	4"	Clear / White	Yes	Plug	0.39 lbs.	60

*New*



*New*

**Indicator Light Bars - 3 LED**

Item #	Size	Lens / Light	Grommet	End Type	Wt. lbs.	Qty.
#81393	16"	Clear / Red	N/A	Bare	0.38 lbs.	100
#81396	16"	Red / Red	N/A	Bare	0.28 lbs.	100



#81393

*New*

**Indicator Light Bars - 9 LED**

Item #	Size	Lens / Light	Grommet	End Type	Wt. lbs.	Qty.
#81398	15-1/2"	Clear / Red	N/A	Bare	0.57 lbs.	50
#81397	15-1/2"	Red / Red	N/A	Bare	0.50 lbs.	50



#81397

**Indicator Light Bar - 9 LED**

Item #	Style	Lens / Light	Grommet	End Type	Wt. lbs.	Qty.
#80360	Chrome	Red / Red	Chrome	Bare	0.44 lbs.	12



**URIAH**



*New*

**Round License Plate Lights - 3 LED**

Item #	Size	Lens / Light	Grommet	End Type	Wt. lbs.	Qty.
#81399	3/4"	Clear / White	Yes	Bare	0.01 lbs.	400
#81672	3/4"	Clear / White	Yes	Bullet	0.03 lbs.	50



*New*

**Square License Plate Lights - 6 LED**

Item #	Size	Lens / Light	Grommet	End Type	Wt. lbs.	Qty.
#81400	2" x 2"	White / Clear	Stainless Steel	Bare	0.09 lbs.	100
#81447	2-5/8" x 1-5/16"	White / Clear	Plastic	Bare	0.04 lbs.	200



*New*

**Round Grommets**

Item #	Size	Finish	Wt. lbs.	Qty.
#81402	3/4"	Rubber	0.01 lbs.	50
#81403	2"	Rubber	0.04 lbs.	50
#81404	2-1/2"	Rubber	0.07 lbs.	50
#81405	4"	Rubber	0.12 lbs.	50
#81725	6"	Rubber	0.13 lbs.	50



**7-Way Plug**

Item #	Type	Finish	Wt. lbs.	Qty.
<i>New</i> #81412	Trailer Side - Self Wire	Plastic	0.18 lbs.	100



**7-Way Socket**

Item #	Type	Finish	Wt. lbs.	Qty.
<i>New</i> #81413	Trailer Side - Self Wire	Plastic	0.26 lbs.	100



**RV Trailer Plugs - 7 Way**

Item #	Type	Wt. lbs.	Qty.
#80366	(A) Single Port	0.25 lbs.	6
#80367	(B) 4 Way Port	0.22 lbs.	8 *



**Trailer Plug - 3 Prong**

Item #	Type	Wt. lbs.	Qty.
#80368	12V	0.13 lbs.	12



*New*

**Light Plugs**

Item #	Type	Finish	Wt. lbs.	Qty.
#81448	2-Pin (PL10)	Plastic	0.02 lbs.	100
#81449	3-Pin (Super 40)	Plastic	0.03 lbs.	100



# TRAILER PARTS TRAILER LIGHTS

*New*

## Break-A-Way Switch

Item #	Cable Length	Finish	Wt. lbs.	Qty.
#81420	Switch & Cable	Plastic	0.36 lbs.	12
#81735	Battery, Charger, Wired, Switch, Indicator	Plastic	4.21 lbs.	1



*New*

## 4-Way Round Wires

Item #	Type	Length	Wt. lbs.	Qty.
#81408	18AWG	5'	0.41 lbs.	100
#81409	18AWG	6'	0.49 lbs.	50
#81410	18AWG	7'	0.64 lbs.	1
#81411	18AWG	10'	0.72 lbs.	50



*New*

## 7-Ways With Wire

Item #	Type	Length	Center Pin	Junction box	Wt. lbs.	Qty.
#81455	10AWG X3, 12AWG X1, 14AWG X4	8'	Yes	No	2.51 lbs.	15
#81456	10AWG X3, 12AWG X1, 14AWG X4	8'	Yes	Yes	3.28 lbs.	1
#81407	14AWG X3, 16AWG X4	10'	Yes	No	2.11 lbs.	20
#81479	14AWG X4, 16AWG X4	10'	No	Yes	2.51 lbs.	12



*New*

## Rolled Wires

Item #	Type	Color	Size	Wt. lbs.	Qty.
#81416	14AWG x 2C Flat Zip Axles / Brakes	Black, White	500'	23.6 lbs.	1
#81417	18AWG x 4C Flat Bonded	Brown, Yellow, Green, White	500'	18.3 lbs.	1
#81643	16AWG X3C Flat Bonded	Brown, Yellow, Green, White	2,500'	87.0 lbs.	1
#81644	16AWG Stranded	Black	2,500'	30.0 lbs.	1
#81645	16AWG Stranded	Blue	2,500'	30.0 lbs.	1
#81646	16AWG Stranded	Brown	2,500'	30.0 lbs.	1
#81647	16AWG Stranded	Green	2,500'	30.0 lbs.	1
#81648	16AWG Stranded	Red	2,500'	30.0 lbs.	1
#81649	16AWG Stranded	Yellow	2,500'	30.0 lbs.	1



## Harness Clip

*New*

Item #	Size (Height x Width)	Thickness	Finish	Wt. lbs.	Qty.
#81602	2-7/8" x 1-1/4"	1/16"	Painted	0.03 lbs.	50



## 7-Way Junction Box

*New*

Item #	Size	Finish	Wt. lbs.	Qty.
#81418	6-1/2" x 3-1/4"	Plastic	0.59 lbs.	50



## Quick Splice

*New*

Item #	Size	Finish	Wt. lbs.	Qty.
#81422	18AWG - 14AWG	Plastic	0.01 lbs.	1,000



## Trailer Light Display

Our Trailer Light display is designed to allow you to mix and match products to suit your needs.

Contact your sales representative today for more information!



### Trailer Light Box

Item #	Size	Finish	Wt. lbs.	Qty.
<i>New</i> #81421	4"	Bare	1.11 lbs.	10



### Trailer Light Box

Item #	Size (Length x Height x Depth)	Finish	Wt. lbs.	Qty.
<i>New</i> #81453	8-3/4" x 4-3/16" x 3-3/4"	Bare	2.70 lbs.	10



### License Plate Bracket

Item #	Size	Finish	Wt. lbs.	Qty.
<i>New</i> #81401	8-1/2"	Bare	0.14 lbs.	200



*Looking for personalized Reflective Tape or Harness?*

*We've got you covered!*

*Call us today to talk to a sales representative!*

*1-866-651-6702*

*New*

### Reflective Tapes - Class 2 Kiss Cut

Item #	Type	Size (Width x Length)	Wt. lbs.	Qty.
#81414	6" Red / 6" Silver	2" x 150'	2.87 lbs.	10
#81415	7" Red / 11" Silver	2" x 150'	2.87 lbs.	10



### Reflective Tape Kit - 4 Stickers

Item #	Size (Width x Length)	Wt. lbs.	Qty.
#80312	2" x 12"	0.12 lbs.	1

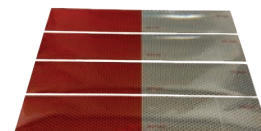

# TRAILER PARTS BALLS / MOUNTS

## Hitch Balls

Item #	Ball Size	Weight Capacity	Shank Length	Shank Diameter	Wt. lbs.	Qty.
#80305	1-7/8"	2,000 lbs.	2-1/2"	3/4"	1.87 lbs.	4
#80304	2"	3,500 lbs.	2"	3/4"	1.75 lbs.	12
#80299	2"	3,500 lbs.	2-3/4"	3/4"	2.20 lbs.	12
#80293	2"	5,000 lbs.	2-3/4"	1"	2.65 lbs.	12
#80295	2-5/16"	6,000 lbs.	2-1/8"	1"	3.25 lbs.	12
#80306	2-5/16"	7,500 lbs.	2-1/4"	1-1/4"	3.81 lbs.	3



## Gooseneck Tow Ball

Item #	Ball Size	Weight Capacity	Finish	Wt. lbs.	Qty.
<i>New</i> #81365	2-5/16"	30,000 lbs.	Zinc	8.19 lbs.	1



*If you need help with an order, have questions about our products, or have an inquiry about setting up an account, please contact a member of our team today!*

*We would love to hear from you!  
1-866-651-6702 or sales@springcreekproducts.com*

## Wheel Bearing Kit

Item #	Size	Fits	Wt. lbs.	Qty.
#80319	1"	BT8 Spindle	0.56 lbs.	12

Kits include: 2 bearings, 2 races, 1 seal, and 1 cotter pin.



## Hub Kits - Replacement Parts

Item #	Number of Bolts	Bolt Circle	Weight Capacity	Fits	Wt. lbs.	Qty.
#80320	5	4-1/2"	1,250 lbs.	BT16 Spindle	7.22 lbs.	1
#80321	4	4"	1,250 lbs.	BT8 Spindle	6.63 lbs.	1



## Trailer Floor Screw

Item #	Size (Diameter x Length)	Finish	Wt. lbs.	Qty.
#50197	5/16" x 2-1/2"	Bare	0.05 lbs.	600

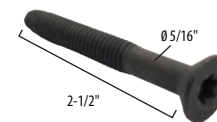

*New*

## Trailer Smooth Fenders

Item #	Style	Size (Length x Height x Depth)	Finish	Wt. lbs.	Qty.
#81094	(A) Tandem	69-1/2" x 21-1/2" x 9"	Bare	29.00 lbs.	1
#81095	(B) Single	32" x 15-3/4" x 8-5/8"	Bare	13.00 lbs.	1
#81096	(C) Teardrop	70-3/4" x 20-1/2" x 9"	Bare	30.00 lbs.	1

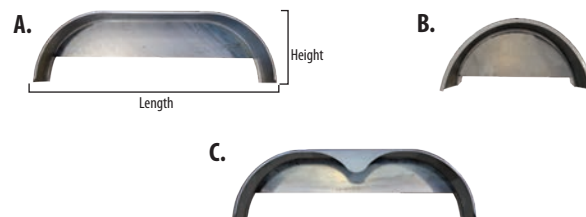



**Square Receiver Sleeve**

Item #	Size	Finish	Wt. lbs.	Qty.
#80372	2"	Powder Coat	3.18 lbs.	1



**4-Hole Channel**

Item #	Size (Length x Width x Height)	Thickness	Finish	Wt. lbs.	Qty.
<i>New</i> #80995	3-5/8" x 2" x 7-3/4"	5/16"	Bare	4.08 lbs.	10

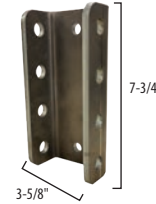

**Channel Bolts**

Item #	Size (Length x Diameter)	Finish	Wt. lbs.	Qty.
<i>New</i> #81092	5" x 5/8"	Zinc	1.04 lbs.	30

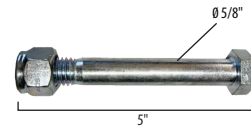

**Trailer Vents**

Item #	Size	Center Hole	Finish	Wt. lbs.	Qty.
#80981	4" x 11ga	1/4"	Bare	0.24 lbs.	10
#80982	6" x 11ga	3/8"	Bare	0.55 bs.	10
#80983	8" x 11ga	3/8"	Bare	0.98 lbs.	10

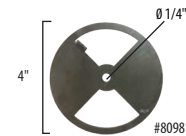

**Weld On Stake Pockets**

Item #	InSide (Length x Height x Depth)	Thickness	Finish	Wt. lbs.	Qty.
#49680	3.55" x 1.69" x 2.88"	4ga	Bare	1.30 lbs.	20
#50022	3.625" x 1.813" x 3"	7ga	Bare	0.95 lbs.	20
<i>New</i> #80991	3.50" x 1.56" x 3"	4ga	Bare	1.24 lbs.	20

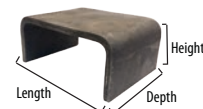

**Rope Hooks**

Item #	Width	Height	Finish	Wt. lbs.	Qty.
<i>New</i> #81083	1/4"	2-1/4"	Zinc	0.03 lbs.	10
#49434	1/2"	4-7/8"	Zinc	0.19 lbs.	10



**Trailer Rope Hooks**

Item #	Diameter	Size (Length x Height)	Type	Finish	Wt. lbs.	Qty.
#49697	3/8"	2-1/4" x 3-13/16"	Straight	Bare	0.22 lbs.	10
#50269	1/2"	2-3/8" x 3-3/8"	Straight	Bare	0.32 lbs.	100
#50270	3/4"	2-1/2" x 4"	Straight	Bare	0.75 lbs.	25
#50268	1/2"	2-3/8" x 4"	Offset	Bare	0.35 lbs.	25

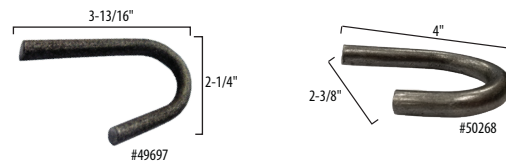

*New*

**Torsion Springs**

Item #	Style / Size	Spring Size (Length x Width)	Finish	Wt. lbs.	Qty.
#80999	(A) Straight / Right	3-3/4" x 2.80"	Bare	3.32 lbs.	1
#81000	(B) Straight / Left	3-3/4" x 2.80"	Bare	3.32 lbs.	1
#81001	(C) Bent / Right	5" x 2"	Bare	2.91 lbs.	1
#81002	(D) Bent / Left	5" x 2"	Bare	2.91 lbs.	1

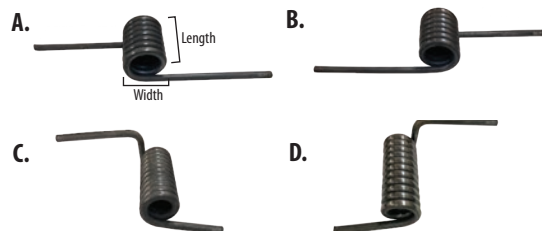

# TRAILER PARTS JACKS / HOOKS

*New*

## Trailer Jacks - Round

Item #	Mount / Wind	Height	Weight Capacity	Finish	Wt. lbs.	Qty.
#81464	Side / Top	15" - 25"	2,000	Powder Coat	10.96 lbs.	1
#81470	Side / Top	15" - 27"	2,000	Powder Coat	11.50 lbs.	1
#81469	Side / Side	16" - 26"	5,000	Powder Coat	14.09 lbs.	1
#81467	A-Frame / Top	19" - 33"	5,000	Powder Coat	9.00 lbs.	1
#81468	A-Frame / Top	19" - 34"	2,000	Powder Coat	9.06 lbs.	1

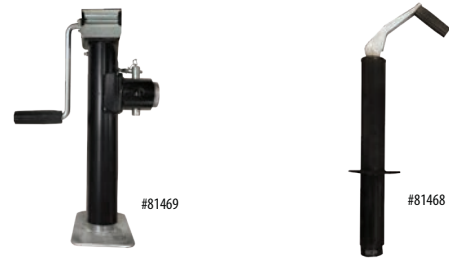

*New*

## Trailer Jacks - Square

Item #	Mount / Wind	Height	Weight Capacity	Finish	Wt. lbs.	Qty.
#81471	Side / Side	16" - 27"	2,000	Powder Coat	12.50 lbs.	1
#81466	None / Top	24" - 39"	8,000	Powder Coat	21.60 lbs.	1
#81465	None / Side	25" - 40"	8,000	Powder Coat	23.26 lbs.	1
#81472	None / Side	28" - 40"	12,000	Powder Coat	40.00 lbs.	1



*New*

## Trailer Jacks With Wheels

Item #	Mount / Wind	Height	Weight Capacity	Finish	Wt. lbs.	Qty.
#81473	Side / Side	23" - 34"	1,200	Zinc	15.00 lbs.	1
#81474	Side / Side	23" - 34"	1,000	Zinc	13.00 lbs.	1



## Trailer Jack Foot

Item #	Finish	Wt. lbs.	Qty.
#80323	Zinc	2.25 lbs.	1



**URIAH**

## Trailer Jack Holder

Item #	Size (Length x Width)	Thickness	Finish	Wt. lbs.	Qty.
#80700	5" x 1-1/8"	14ga	Bare	0.21 lbs.	50



## Clevis Hooks

Item #	Size	Grade	Max L.L.	Finish	Wt. lbs.	Qty.
#48046	1/4"	70	3,500 lbs.	Zinc	0.36 lbs.	50
#49895	5/16"	43	3,900 lbs.	Zinc	0.78 lbs.	100
#48047	5/16"	70	4,500 lbs.	Zinc	0.76 lbs.	20
#49896	3/8"	43	5,400 lbs.	Zinc	1.13 lbs.	100
#48048	3/8"	70	7,100 lbs.	Zinc	1.01 lbs.	20
#48049	1/2"	70	12,000 lbs.	Zinc	2.24 lbs.	10



## Clevis Slip Hooks

Item #	Size	Grade	Latch	Finish	Wt. lbs.	Qty.
#49890	5/16"	43	No	Zinc	0.88 lbs.	10
#49893	5/16"	43	Yes	Zinc	0.88 lbs.	10
#49891	3/8"	43	No	Zinc	1.31 lbs.	25
#49894	3/8"	43	Yes	Zinc	1.38 lbs.	10



No Latch



Latch

## Weld On Grab Hooks - Grade 43

Item #	Size	Dimension (Length x Width x Height)	Working L.L.	MBS	Finish	Wt. lbs.	Qty.
#48850	5/16"	2" x 5/8" x 2-1/2"	3,900 lbs.	11,700 lbs.	Bare	0.49 lbs.	20
#48848	3/8"	2-3/8" x 3/4" x 3"	5,400 lbs.	16,200 lbs.	Bare	0.87 lbs.	20
#48847	1/2"	3-1/8" x 1" x 4"	9,200 lbs.	27,886 lbs.	Bare	1.70 lbs.	20



**70 Proof Transport Chains**

Item #	Size	Length	Hook	Finish	Wt. lbs.	Qty.
#47896	5/16"	20'	Yes	Chromate	21.50 lbs.	1
#49659	5/16"	275'	No	Chromate	240.00 lbs.	Drum
#47897	3/8"	20'	Yes	Chromate	34.00 lbs.	1
#49205	3/8"	63'	No	Chromate	90.00 lbs.	Pail



5/16" x 20' Shown

**Safety Chains With Single Clevis Hook**

Item #	Size (Diameter x Length)	Grade	Finish	Wt. lbs.	Qty.
#80393	5/16" x 35"	30	Zinc	3.10 lbs.	10
#49922	5/16" x 35"	43	Zinc	3.13 lbs.	10
#49923	3/8" x 35"	43	Zinc	4.90 lbs.	10



Latch and 35" Chain

**Safety Chains With Double "S" Hooks**

Item #	Size (Diameter x Length)	Capacity	Finish	Wt. lbs.	Qty.
<i>New</i> #81091	5/16" x 30"	2,500 lbs.	Zinc	2.38 lbs.	15
#80292	3/8" x 36"	3,000 lbs.	Zinc	1.60 lbs.	5 *
#80294	7/16" x 36"	5,000 lbs.	Zinc	2.60 lbs.	5
#80998	7/16" x 36"	5,000 lbs.	Zinc	2.60 lbs.	40 *Bulk Item



**Safety Chain With Clevis Hooks**

Item #	Size (Diameter x Length)	Capacity	Finish	Wt. lbs.	Qty.
#80296	5/16" x 30"	7,600 lbs.	Zinc	3.06 lbs.	3



**Square Pails And Drums Of Chain**

Item #	Size	Length	Proof	Finish	Wt. lbs.	Qty.
#50001	1/8"	270'	30	Zinc	54.00 lbs.	Pail
#49016	3/16"	150'	30	Zinc	53.90 lbs.	Pail
#50142	3/16"	1,500'	30	Zinc	515.88 lbs.	Drum
#80768	3/16"	150'	30	Bare	53.90 lbs.	Pail
#49017	1/4"	100'	30	Zinc	56.00 lbs.	Pail
#80633	1/4"	800'	30	Zinc	532.00 lbs.	Drum
#80769	1/4"	100'	30	Bare	56.00 lbs.	Pail
#49018	5/16"	75'	30	Zinc	61.00 lbs.	Pail
#49019	3/8"	45'	30	Zinc	54.00 lbs.	Pail
#50002	1/2"	40'	30	Zinc	97.00 lbs.	Pail
#50143	1/2"	200'	30	Zinc	475.00 lbs.	Drum
#50144	5/8"	150'	30	Zinc	520.00 lbs.	Drum



**Twisted Link Chain #4**

Item #	Size	Length	Working L.L.	Finish	Wt. lbs.	Qty.
#80229	1/8"	200'	205 lbs.	Zinc	25.00 lbs.	1



**Aircraft Cables 7 x 19**

Item #	Size	Finish	Wt. lbs.	Qty.
#49365	1/8" x 500'	Galvanized	14.50 lbs.	1
#49366	3/16" x 500'	Galvanized	32.50 lbs.	1
#49367	1/4" x 500'	Galvanized	55.00 lbs.	1
#49368	5/16" x 250'	Galvanized	43.30 lbs.	1
#50122	5/16" x 500'	Galvanized	86.00 lbs.	1
#49369	3/8" x 250'	Galvanized	60.80 lbs.	1

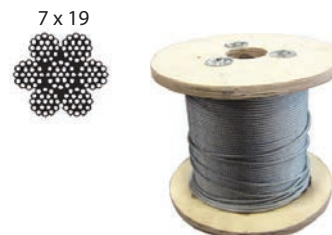

# RIGGING LASHING RINGS

## Lashing Rings - Weld On

Item #	Size	Working L.L.	MBS	Inner (Width x Height)	Outer (Width x Height)	Finish	Wt. lbs.	Qty.
#48195 #80460	1/2"	4,000 lbs.	12,000 lbs.	2-1/4" x 2-1/2"	3-1/4" x 3-1/2"	Bare	0.94 lbs.	20/box 500/crate
#48196 #80193	5/8"	6,000 lbs.	18,000 lbs.	3" x 3"	4-1/4" x 4-1/4"	Bare	1.90 lbs.	20/box 500/crate
#48197	3/4"	8,833 lbs.	26,500 lbs.	3" x 3"	4-1/2" x 4-1/2"	Bare	2.50 lbs.	10
#48198	1"	15,666 lbs.	47,000 lbs.	3" x 3"	5" x 5"	Bare	4.16 lbs.	10
#50341 #80364	1"	15,586 lbs.	47,000 lbs.	3" x 4"	5" x 6"	Bare	4.65 lbs.	8/box 256/crate



## Rotating Lashing Ring - Weld On

Item #	Size	Working L.L.	Inner (Width x Height)	Outer (Width x Height)	Finish	Wt. lbs.	Qty.
#80231	1"	15,586 lbs.	3" x 2"	5" x 6"	Bare	7.37 lbs.	5



## Bent Lashing Rings - Weld On

Item #	Size	Working L.L.	Inner (Width x Height)	Outer (Width x Height)	Finish	Wt. lbs.	Qty.
#50345 #80398	1"	15,586 lbs.	3" x 3-1/2"	5" x 5-1/2"	Bare	4.46 lbs.	8 / box 256 / crate

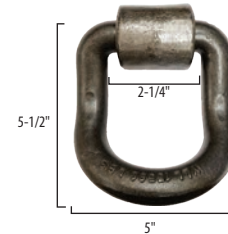

## Lashing Ring - Weld On

Item #	Size	Working L.L.	Dimension (Length x Height)	Finish	Wt. lbs.	Qty.
#50110	3/8"	2,000	3-5/16" x 2-3/4"	Zinc	0.45 lbs.	20



## Lashing Rings - Bolt On

Item #	Size	Working L.L.	MBS	Outer (Width x Height)	Finish	Wt. lbs.	Qty.
#49988	(A) 1/4"	700 lbs.	N/A	1-1/2" x 2"	Zinc	0.12 lbs.	300
#49362	(B) 1/2"	4,000 lbs.	12,000 lbs.	1-3/4" x 3-1/2"	Bare	1.00 lbs.	20

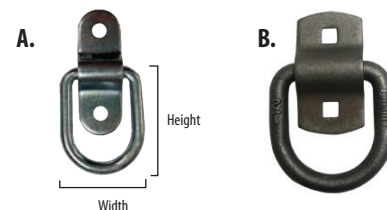

## Horseshoe Stall Tie-Down

Item #	Size	Finish	Wt. lbs.	Qty.
#47690	4-3/8" x 6" x 1-1/4"	Bare	1.53 lbs.	25





## Lashing Rings - Bolt On

Item #	Type	Working L.L.	MBS	Dimension (Length x Height)	Finish	Wt. lbs.	Qty.
#49431	(A) 1/4" Square	N/A	N/A	4" x 3-3/4"	Zinc	1.00 lbs.	1
#49989	(B) 1/4" Oval	1,200 lbs.	1,200 lbs.	3-1/2" x 5"	Zinc	0.41 lbs.	100
#49990	(C) 1/4" Round with Plastic Trim	500 lbs.	N/A	4"	Zinc	0.31 lbs.	100
#49991	(D) 5/16" Square	6,000 lbs.	6,000 lbs.	4-1/2" x 4-7/8"	Zinc	1.13 lbs.	25
#49992	(E) Rotating Ring	6,000 lbs.	6,000 lbs.	6-1/16"	Zinc	2.28 lbs.	20

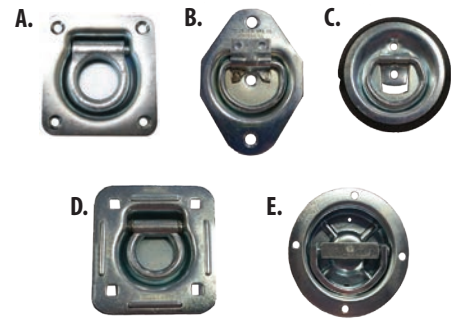

## Weld On "C" Hook

Item #	Size	Break Strength	Working L.L.	Wt. lbs.	Qty.
<i>New</i> #81111	5/8"	6,000 lbs.	3,000 lbs.	0.79 lbs.	40



## Tie Loops

Item #	Size (Inside Dia. x Dia.)	Leg Length	Type	Shape	Finish	Wt. lbs.	Qty.
#49886	2" x 1/2"	2-1/4"	Aluminium-Bolt On	Round	Bare	0.15 lbs.	50
#49889	2" x 1/2"	2"	Steel - Weld On	Round	Bare	0.13 lbs.	50
#49888	2-1/4" x 3/8"	1-7/8"	Steel - Weld On	Square	Bare	0.34 lbs.	50
#49963	2-1/4" x 3/8"	3/4"	Steel - Weld On	Square	Bare	0.34 lbs.	50
#50067	5" x 1/2"	2-1/4"	Steel - Weld On	Square	Bare	0.55 lbs.	50



## Weld On Safety Chain Clips

Item #	Size (Length x Diameter)	Finish	Wt. lbs.	Qty.
#50012	4" x 3/8"	Bare	0.15 lbs.	50
#50013	4" x 7/16"	Bare	0.19 lbs.	220
#50014	6" x 1/2"	Bare	0.36 lbs.	120



## Chain Retainers

Item #	Fits	Pin Size	Overall Length	Finish	Wt. lbs.	Qty.
#80026	5/16"	3/8"	3-7/8"	Bare	0.61 lbs.	40
#80027	3/8"	1/2"	4-1/2"	Bare	0.97 lbs.	30
<i>New</i> #81591	1/2"	5/8"	4-1/2"	Bare	1.52 lbs.	20



## Coupling Links

Item #	Size	Grade	Working L.L.	Finish	Wt. lbs.	Qty.
#80045	9/23"	80	3,500 lbs.	Painted	0.26 lbs.	50
#49690	5/16"	100	5,700 lbs.	Painted	0.42 lbs.	50



## Round Steel Pin

Item #	Size (Diameter x Length)	Finish	Wt. lbs.	Qty.
#50391	3/4" x 3"	Bare	0.35 lbs.	50

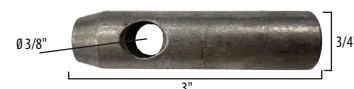

**Assorted Cotter Pin Kit**

Item #	Size (Width x Usable Length)	Pieces	Finish	Wt. lbs.	Qty.
#50450	1/8" x 1-1/2"	100	Zinc	5.05 lbs.	10
	5/32" x 1-1/2"	48			
	5/32" x 2-1/2"	56			
	3/16" x 2"	56			
	1/4" x 2-1/2"	15			
	5/16" x 4"	10			
3/8" x 3-1/8"	5				

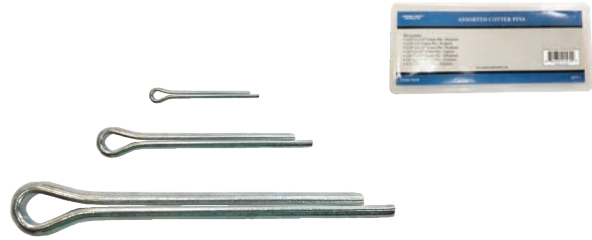

**Snapper Pins - Round**

Item #	Size (Diameter x Usable Length)	Finish	Wt. lbs.	Qty.
#50102	1/4" x 1-3/4"	Zinc	0.14 lbs.	20
#49854	1/4" x 2-3/4"	Zinc	0.06 lbs.	40
#49857	5/16" x 2"	Zinc	0.09 lbs.	30
#49858	3/8" x 2-3/4"	Zinc	0.14 lbs.	30



**Snapper Pins - Square**

Item #	Size (Diameter x Usable Length)	Finish	Wt. lbs.	Qty.
#49852	1/4" x 1-3/4"	Zinc	0.06 lbs.	50
#49856	1/4" x 2-1/2"	Zinc	0.06 lbs.	1
#49853	5/16" x 2-1/4"	Zinc	0.13 lbs.	50
#49855	3/8" x 2-1/4"	Zinc	0.09 lbs.	1



**Assorted Snapper Pin Kit**

Item #	Size (Diameter x Usable Length)	Style	Pieces	Finish	Wt. lbs.	Qty.
#50448	1/4" x 2-1/4"	Round	10	Zinc	2.45 lbs.	10
	3/8" x 2-3/8"	Round	5			
	5/16" x 2-5/16"	Square	7			



**Linchpins**

Item #	Size (Diameter x Usable Length)	Finish	Wt. lbs.	Qty.
#49956	1/4" x 1-3/4"	Zinc	0.04 lbs.	100
#49957	3/16" x 1-5/8"	Zinc	0.03 lbs.	20
#49958	5/16" x 1-3/4"	Zinc	0.06 lbs.	100
#49959	7/16" x 2-5/8"	Zinc	0.16 lbs.	100
#49960	7/16" x 2-1/2" HD	Zinc	0.13 lbs.	100



**Assorted Linchpin Kit**

Item #	Size (Diameter x Usable Length)	Pieces	Finish	Wt. lbs.	Qty.
#50449	1/4" x 1-7/16"	18	Zinc	3.20 lbs.	10
	3/16" x 1-1/4"	16			
	5/16" x 1-1/2"	6			
	7/16" x 1-1/2"	10			



**R-Pin**

Item #	Size (Diameter x Length)	Finish	Wt. lbs.	Qty.
#50524	5/8" x 2-3/8"	Zinc	0.01 lbs.	50



**Assorted R-Pin Kit**

Item #	Size (Diameter x Length)	Pieces	Finish	Wt. lbs.	Qty.
#50452	3/32" x 2-7/16"	30	Zinc	3.20 lbs.	10
	1/16" x 2-3/8"	20			
	1/8" x 2-13/16"	20			
	5/32" x 3"	20			
	3/16" x 3-3/8"	8			
	5/16" x 5-5/16"	3			



**Assorted Double R-Pin Kit**

Item #	Size (Diameter x Length)	Pieces	Finish	Wt. lbs.	Qty.
#50451	3/32" x 3"	28	Zinc	2.55 lbs.	10
	5/32" x 3-1/4"	13			
	3/16" x 4"	9			



See the newest additions on our website,  
[www.springcreekproducts.com](http://www.springcreekproducts.com)

**Hitch Pin Bent**

Item #	Size	Finish	Wt. lbs.	Qty.
#80725	5/8" x 3"	Zinc	0.52 lbs.	50 *Bulk Item



**Hitch Pins**

Item #	Size (Diameter x Usable Length)	Finish	Wt. lbs.	Qty.
#49942	1/2" x 3-1/2"	Zinc	0.41 lbs.	10
#49944	5/8" x 4-1/2"	Zinc	0.69 lbs.	1
#49945	5/8" x 6"	Zinc	0.81 lbs.	5
#49948	3/4" x 4-1/2"	Zinc	0.91 lbs.	1
#49949	3/4" x 6"	Zinc	1.13 lbs.	50
#49953	1" x 6"	Zinc	1.88 lbs.	12



**Hitch Pins With Weld Handle**

Item #	Size (Diameter x Usable Length)	Finish	Wt. lbs.	Qty.
#50453	3/4" x 5-1/8"	Zinc	1.10 lbs.	5
#50454	3/4" x 6-7/8"	Zinc	1.20 lbs.	5
#50455	7/8" x 5-1/8"	Zinc	1.40 lbs.	5
#50456	1" x 5-1/8"	Zinc	1.80 lbs.	5
#50457	1" x 6-7/8"	Zinc	2.00 lbs.	5
#50458	1-1/8" x 5-1/8"	Zinc	2.10 lbs.	5
#50459	1-1/8" x 6-7/8"	Zinc	2.50 lbs.	5
#50460	1-1/4" x 6-7/8"	Zinc	3.00 lbs.	5



## U-Bolts

Item #	Size	Finish	Wt. lbs.	Qty.
#48915	1"	Zinc	0.09 lbs.	10
#48916	1-3/8"	Zinc	0.17 lbs.	20
#48917	1-3/4"	Zinc	0.21 lbs.	20
#48918	2"	Zinc	0.34 lbs.	10
#48919	2-1/2"	Zinc	0.34 lbs.	10
#48920	3"	Zinc	0.44 lbs.	20



## Screw Pin Anchor Shackles

Item #	Size	Finish	Wt. lbs.	Qty.
#48891	1/4"	HDG	0.11 lbs.	10
#48892	5/16"	HDG	0.19 lbs.	10
#48893	3/8"	HDG	0.29 lbs.	10
#48894	1/2"	HDG	0.66 lbs.	10
#48895	5/8"	HDG	1.37 lbs.	10
#49126	3/4"	HDG	2.19 lbs.	10
#49127	1"	HDG	5.20 lbs.	10



## Wire Rope Clips

Item #	Size	Finish	Wt. lbs.	Qty.
#48904	1/8"	Zinc	0.03 lbs.	20
#48905	3/16"	Zinc	0.06 lbs.	10
#48906	1/4"	Zinc	0.06 lbs.	20
#48907	5/16"	Zinc	0.13 lbs.	20
#48908	3/8"	Zinc	0.21 lbs.	20
#50426	3/8"	HDG	0.46 lbs.	50
#49097	1/2"	Zinc	0.40 lbs.	20
#80072	9/16"	Zinc	0.45 lbs.	20
#49128	5/8"	Zinc	0.59 lbs.	10



## S-Hooks

Item #	Size (Diameter x Length)	Finish	Wt. lbs.	Qty.
#48877	1/8" x 1-1/4"	Zinc	0.01 lbs.	100
#49918	5/32" x 1-1/4"	Zinc	0.02 lbs.	100
#48880	5/32" x 1-1/2"	Zinc	0.02 lbs.	100
#48881	3/16" x 1-3/4"	Zinc	0.04 lbs.	20
#48882	1/4" x 2-3/8"	Zinc	0.06 lbs.	20
#49919	5/16" x 2-5/8"	Zinc	0.17 lbs.	20
#48884	5/16" x 3-1/8"	Zinc	0.17 lbs.	20
#48885	3/8" x 4"	Zinc	0.29 lbs.	50



## "S" Hooks

Item #	Size	Finish	Capacity	Wt. lbs.	Qty.
#80287	3/8"	Zinc	1,200 lbs.	0.47 lbs.	12
#80289	7/16"	Zinc	2,500 lbs.	0.69 lbs.	12

Packaged with two "S" hooks





**Swivel Eye Snaps**

Item #	Size (Eye x Length)	Finish	Wt. lbs.	Qty.
#49401	3/8" x 3"	Bronze	1.01 lbs.	10
#49901	3/4" x 3-11/16"	Nickel	0.09 lbs.	10



**Double Chain Snaps**

Item #	Size	Finish	Wt. lbs.	Qty.
#49398	1/4" x 3-1/2"	Bronze	0.10 lbs.	10
#49395	1/4" x 3-1/2"	Nickel	0.10 lbs.	50
#49396	3/8" x 4"	Nickel	0.10 lbs.	10
#49399	3/8" x 4-5/8"	Bronze	0.16 lbs.	10
#49397	3/8" x 4-5/8"	Nickel	0.16 lbs.	20



**Snap Hook With Open Eye**

Item #	Size (Eye x Length)	Finish	Wt. lbs.	Qty.
#49899	3/8" x 3-1/2"	Zinc	0.13 lbs.	10



**Swivel Snaps**

Item #	Type	Size	Finish	Wt. lbs.	Qty.
#49402	Trigger	3/8" x 2-1/2"	Bronze	1.01 lbs.	10
#49400	Loop	3/8" x 3-1/8"	Nickel	0.12 lbs.	10



Trigger



Loop

**Quick Links**

Item #	Size	Finish	Wt. lbs.	Qty.
#48896	1/4"	Zinc	0.08 lbs.	10
#48897	5/16"	Zinc	0.17 lbs.	10
#48898	3/8"	Zinc	0.29 lbs.	10
#48899	1/2"	Zinc	0.55 lbs.	10



**Spring Hooks**

Item #	Size	Finish	Wt. lbs.	Qty.
#48954	3/16"	Zinc	0.04 lbs.	10
#48900	1/4"	Zinc	0.06 lbs.	10
#48901	5/16"	Zinc	0.14 lbs.	10
#48902	3/8"	Zinc	0.28 lbs.	10
#48903	1/2"	Zinc	0.55 lbs.	10



**Wire Rope Thimbles**

Item #	Size	Finish	Wt. lbs.	Qty.
#48886	3/16"	Zinc	0.03 lbs.	25
#48887	1/4"	Zinc	0.03 lbs.	25
#48888	5/16"	Zinc	0.04 lbs.	20
#48890	1/2"	Zinc	0.11 lbs.	100



**Steel Ring**

Item #	Size	Finish	Wt. lbs.	Qty.
#49403	2"	Nickel	0.08 lbs.	20



# RIGGING TURNBUCKLES

## Turnbuckles - Eye And Eye

Item #	Size (Diameter x Body)	Length (Closed / Open)		Finish	Wt. lbs.	Qty.
#49183	1/2" x 6"	13-3/4"	19-1/4"	HDG	1.35 lbs.	20
#49088	1/2" x 9"	17-1/4"	24-11/16"	HDG	1.73 lbs.	20
#49093	1/2" x 12"	19-7/8"	31-7/16"	HDG	2.06 lbs.	20



## Turnbuckles - Eye And Eye

Item #	Size (Diameter x Body)	Length (Closed / Open)		Finish	Wt. lbs.	Qty.
#48873	3/16" x 5-1/2"	8-1/2"	10-5/8"	Zinc	0.09 lbs.	10
#48874	1/4" x 2-1/2"	5-1/2"	7-5/8"	Zinc	0.13 lbs.	50
#48875	5/16" x 2-7/8"	6"	8-1/2"	Zinc	0.22 lbs.	50

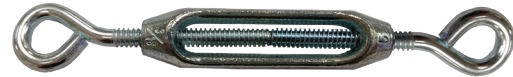

## Turnbuckles - Hook And Eye

Item #	Size (Diameter x Body)	Length (Closed / Open)		Finish	Wt. lbs.	Qty.
#49798	3/8" x 6"	12-1/8"	17-7/16"	HDG	0.75 lbs.	20
#49182	1/2" x 6"	17-1/4"	19-3/4"	HDG	1.61 lbs.	20
#49090	1/2" x 9"	16-1/2"	24-7/8"	HDG	1.90 lbs.	20
#49095	1/2" x 12-1/4"	20"	31-5/8"	HDG	2.27 lbs.	20
#49797	5/8" x 9"	18-1/2"	26-7/8"	HDG	3.04 lbs.	10



## Turnbuckles - Hook And Eye

Item #	Size (Diameter x Body)	Length (Closed / Open)		Finish	Wt. lbs.	Qty.
#48869	3/16" x 1-5/8"	4-1/2"	5-7/8"	Zinc	0.06 lbs.	10
#48870	1/4" x 2-1/2"	5-1/2"	7-5/8"	Zinc	0.13 lbs.	50
#48871	5/16" x 2-7/8"	6-3/4"	9-1/8"	Zinc	0.24 lbs.	10
#48872	3/8" x 3"	7"	9-1/2"	Zinc	0.34 lbs.	20

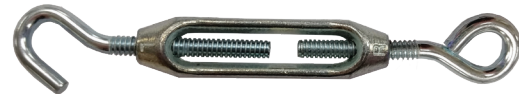

## Turnbuckles - Hook And Hook

Item #	Size (Diameter x Body)	Length (Closed / Open)		Finish	Wt. lbs.	Qty.
#49087	1/2" x 9"	16-1/2"	24-3/4"	HDG	1.93 lbs.	20
#49092	1/2" x 12"	19-3/4"	31-1/2"	HDG	2.36 lbs.	20



## Turnbuckles - Jaw And Eye

Item #	Size (Diameter x Body)	Length (Closed / Open)		Finish	Wt. lbs.	Qty.
#49091	1/2" x 9"	16-7/8"	25-1/4"	HDG	1.75 lbs.	20
#49096	1/2" x 12"	19-1/2"	31"	HDG	2.04 lbs.	20



## Turnbuckles - Jaw And Jaw

Item #	Size (Diameter x Body)	Length (Closed / Open)		Finish	Wt. lbs.	Qty.
#49089	1/2" x 9"	16-1/2"	24-7/8"	HDG	1.85 lbs.	20
#49094	1/2" x 12"	19-1/4"	32-1/2"	HDG	2.20 lbs.	20



**Eyebolts**

Item #	Size (Diameter x Shaft)	Overall Length	Thread Length	Eye I.D.	Finish	Wt. lbs.	Qty.
#48853	1/4" x 4"	5"	2-3/8"	1/2"	HDG	0.09 lbs.	10
#48854	5/16" x 2-1/4"	3-1/2"	1-1/2"	5/8"	HDG	0.12 lbs.	10
#48855	5/16" x 4-1/8"	5-7/16"	2-1/2"	5/8"	HDG	0.14 lbs.	10
#48856	3/8" x 2-1/2"	4"	1-1/2"	3/4"	HDG	0.20 lbs.	10
#48857	5/16" x 4-1/2"	6"	2-5/8"	3/4"	HDG	0.23 lbs.	10
#48858	3/8" x 6"	7-1/2"	2-1/2"	3/4"	HDG	0.31 lbs.	10
#48859	1/2" x 6-1/4"	8-3/8"	3-1/8"	1"	HDG	0.66 lbs.	20
#48860	1/2" x 8-1/4"	10-1/4"	3"	1"	HDG	0.76 lbs.	10
#48861	1/2" x 10"	12"	3"	1"	HDG	0.78 lbs.	10
#49873	1/2" x 12"	14-1/4"	3-1/8"	1"	HDG	0.76 lbs.	20



**Eyebolts**

Item #	Size (Diameter x Shaft)	Overall Length	Thread Length	Eye I.D.	Finish	Wt. lbs.	Qty.
#50121	1/2" x 3-7/8"	6"	3"	1-3/16"	Zinc	0.42 lbs.	10
#80089	1/2" x 9-7/8"	12"	3"	1-3/16"	Zinc	0.69 lbs.	10
#48862	1/2" x 12-1/4"	14-1/2"	3-7/8"	1-3/16"	Zinc	0.79 lbs.	10



**Battery Clamps**

Item #	Size	Finish	Wt. lbs.	Qty.
<i>New</i> #81476	10" X 4ga	Zinc	0.21 lbs.	100



**J-Bolt Cane**

Item #	Size	Finish	Wt. lbs.	Qty.
#80111	4-1/2"	Zinc	0.31 lbs.	100



*Shipping throughout  
the U.S.A.*

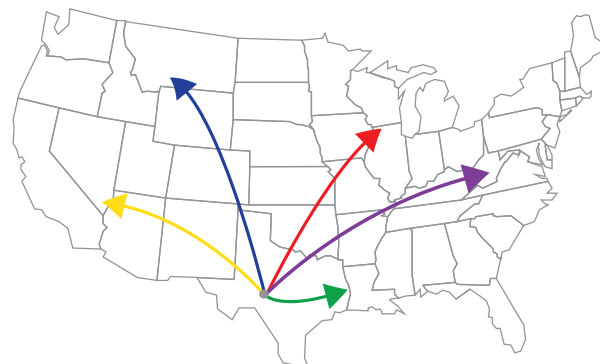

*New*

## Multi-Purpose Zip Ties

Item #	Size	Pcs/Bag	Color	Wt. lbs.	Box Qty.
#81502	8"	100	Black	0.12 lbs.	140
#81503	14"	100	Black	0.20 lbs.	85



## Yellow Poly Hollow Braid Ropes

Item #	Size	Length	Wt. lbs.	Qty.
#50212	1/4"	100'	0.74 lbs.	6
#50213	3/8"	50'	0.69 lbs.	6



## Bungee Cords - Assorted Pack

Item #	Size	Pieces	Color	Wt. lbs.	Qty.
<i>New</i> #81561	Canopy	4	Black	2.75 lbs.	12
	Mini	6	Black		
	18"	6	Blue		
	24"	4	Red		
	32"	2	Green		
	40"	2	Yellow		



## Ratchet Tie-Down Straps "S" Hooks 1" x 12'

Item #	Color	Break Strength	Working L.L.	Wt. lbs.	Qty.
#47882	Blue	1,200 lbs.	400 lbs.	2.00 lbs.	12
#48419	Red	1,200 lbs.	400 lbs.	2.00 lbs.	12
#48421	Yellow	1,200 lbs.	400 lbs.	2.00 lbs.	12
#48422	Black	1,200 lbs.	400 lbs.	2.00 lbs.	12
#48423	Camo	1,200 lbs.	400 lbs.	2.00 lbs.	12



## Ratchet Tie-Down Straps "S" Hooks 1" x 15'

Item #	Color	Break Strength	Working L.L.	Wt. lbs.	Qty.
#48429	Blue	3,000 lbs.	1,000 lbs.	4.06 lbs.	6
#48430	Red	3,000 lbs.	1,000 lbs.	4.06 lbs.	6
#48432	Yellow	3,000 lbs.	1,000 lbs.	4.06 lbs.	6
#48433	Black	3,000 lbs.	1,000 lbs.	4.06 lbs.	6
#48434	Camo	3,000 lbs.	1,000 lbs.	4.52 lbs.	6



## Ratchet Tie-Down Strap With Extension Chain

Item #	Size	Break Strength	Working L.L.	Wt. lbs.	Qty.
#49497	2" x 27'	10,000 lbs.	3,333 lbs.	7.00 lbs.	8



## Winch Strap With Extension Chain

Item #	Size	Break Strength	Working L.L.	Wt. lbs.	Qty.
#49499	4" x 30'	16,200 lbs.	5,400 lbs.	6.00 lbs.	5



## Ratchet Tie-Down Strap - Flat Hooks

Item #	Size	Break Strength	Working L.L.	Wt. lbs.	Qty.
#47890	2" x 27'	10,000 lbs.	3,333 lbs.	5.38 lbs.	10





## Ratchet Tie-Down Straps - Double J Hooks

Item #	Size	Break Strength	Working L.L.	Wt. lbs.	Qty.
#47889	2" x 27'	10,000 lbs.	3,333 lbs.	4.94 lbs.	10



## Winch Strap With Flat Hook

Item #	Size	Break Strength	Working L.L.	Wt. lbs.	Qty.
#47888	4" x 30'	16,200 lbs.	5,400 lbs.	4.80 lbs.	4



*New*

## Recovery Tow Straps

Item #	Size	Break Strength	Working L.L.	Wt. lbs.	Qty.
#81101	2" x 20'	14,000 lbs.	4,666 lbs.	1.87 lbs.	20
#81673	2" x 20'	32,000 lbs.	6,400 lbs.	4.56 lbs.	1
#81674	3" x 10'	46,000 lbs.	9,000 lbs.	4.02 lbs.	1
#81675	4" x 12'	57,500 lbs.	11,500 lbs.	6.49 lbs.	1
#81676	4" x 18'	100,000 lbs.	22,000 lbs.	18.00 lbs.	1



## Winch Bars

Item #	Type	Finish	Wt. lbs.	Qty.
#47891	Combination	Chrome	6.44 lbs.	10
#47892	Standard	Chrome	5.07 lbs.	10



Combination

## Portable Webbing Winches

Item #	Style	Finish	Wt. lbs.	Qty.
#47893	Bolt On	Powder Coat	8.84 lbs.	5
#80088	Weld On	Powder Coat	8.60 lbs.	5



Bolt On



Weld On

## Lever Load Binder

Item #	Accommodates	Break Strength	Finish	Wt. lbs.	Qty.
#47894	5/16" - 3/8"	19,000 lbs.	Powder Coat	8.29 lbs.	6



## Ratchet Binder

Item #	Accommodates	Break Strength	Finish	Wt. lbs.	Qty.
#47895	5/16" - 3/8"	19,000 lbs.	Powder Coat	10.61 lbs.	4



# PREMIER STEEL DOORS AND FRAMES



## Metal Doors

- 20 gauge insulated
- Galvanized
- Heavy-duty reinforcements
- Non Handed

- #50030 - 3' with dead lock (#3070)
- #50033 - 3' without deadlock (#3070)

---

- #50035 - 4' without deadlock (#4070)

These items do not qualify for free freight



## Door Knob

- Delaney Commercial Grade 2 Cylindrical Knobset
- Stainless Steel
- #50032 - Knob Lock

## Metal Frames

- 16 gauge insulated
- Galvanized
- All frames include basic knob set

- #50031 - 4-1/4" without deadlock (#3070)

---

- #80631 - 6-1/4" with deadlock (#3070)
- #50037 - 6-1/4" without deadlock (#3070)
- #50038 - 6-1/4" without deadlock (#4070)

---

- #50039 - 8-1/4" with deadlock (#3070)

---

- #50054 - 8-1/4" without deadlock (#3070)
- #50055 - 8-1/4" without deadlock (#4070)

Free Freight Does Not Apply

### Other items available for special order:

- Grade 1, 2, and 3 Locksets
- Deadbolts, Rim Cylinders, Deadlatch Mortise Locks
- Door Closers
- Exit Devices
- Hinges and Door Trim
- Doors and Frames

### Tacky Tape

Item #	Size	Wt. lbs.	Qty.
#48525	3/32" x 3/8" x 45'	1.17 lbs.	48



### Round Roof Jacks

Item #	Pipe Size	Base	Wt. lbs.	Qty.
#48523	2-1/4" x 4-3/4"	8"	0.52 lbs.	10
#48524	4-1/4" x 7-1/2"	11"	1.08 lbs.	10



#48523



#48524

**Self Drill Screws (5/16" Hex Head Size)**

**Self Drill Screws - #12-14 x 1"**

Item #	Color	Wt. lbs.	Qty.
#48485	Plain	0.01 lbs.	250
#48486	Polar White	0.01 lbs.	250
#48487	Mocha Tan	0.01 lbs.	250
#48488	Light Stone	0.01 lbs.	250
#48489	Rustic Red	0.01 lbs.	250
#48490	Slate	0.01 lbs.	250
#48491	Brown	0.01 lbs.	250
#48492	Ash Grey	0.01 lbs.	250
#48493	Charcoal	0.01 lbs.	250
#48494	Hawaiian Blue	0.01 lbs.	250
#49026	Forest Green	0.01 lbs.	250



**Lap Drill Screws - #14 x 7/8"**

Item #	Color	Wt. lbs.	Qty.
#48495	Plain	0.01 lbs.	250
#48496	Polar White	0.01 lbs.	250
#48497	Mocha Tan	0.01 lbs.	250
#48498	Light Stone	0.01 lbs.	250
#48499	Rustic Red	0.01 lbs.	250
#48500	Slate	0.01 lbs.	250
#48501	Brown	0.01 lbs.	250
#48502	Ash Grey	0.01 lbs.	250
#48503	Charcoal	0.01 lbs.	250
#48504	Hawaiian Blue	0.01 lbs.	250
#49027	Forest Green	0.01 lbs.	250



**Metal To Wood Screws - #10 x 1-1/2"**

Item #	Color	Wt. lbs.	Qty.
#48505	Plain	0.01 lbs.	250
#48506	Polar White	0.01 lbs.	250
#48507	Mocha Tan	0.01 lbs.	250
#48508	Light Stone	0.01 lbs.	250
#48509	Rustic Red	0.01 lbs.	250
#48510	Slate	0.01 lbs.	250
#48511	Brown	0.01 lbs.	250
#48512	Ash Grey	0.01 lbs.	250
#48513	Charcoal	0.01 lbs.	250
#48514	Hawaiian Blue	0.01 lbs.	250



Color Choices



\*\*Tones may vary from image

**Hillside Washer 1/2"**

Item #	Finish	Wt. lbs.	Qty.
#49794	Bare	0.35 lbs.	50



**Nail Anchors**

Item #	Size	Finish	Wt. lbs.	Qty.
#49884	1/4" x 1-1/4"	Bare	0.02 lbs.	100
#50015	1/4" x 1-1/2"	Bare	0.02 lbs.	100
#49997	1/4" x 2"	Bare	0.03 lbs.	100



**Wedge Anchors**

Item #	Size (Diameter x Length)	Minimum Embedment	Finish	Wt. lbs.	Qty.
#49877	3/8" x 2-3/4"	1-1/2"	Zinc	0.09 lbs.	100
#49878	1/2" x 4-1/4"	2-1/4"	Zinc	0.25 lbs.	25
#50228	1/2" x 7"	2-1/4"	Zinc	0.36 lbs.	25
#49880	5/8" x 6"	2-3/4"	Zinc	0.50 lbs.	25
#49881	3/4" x 4-3/4"	3-1/2"	Zinc	0.65 lbs.	20
#49883	3/4" x 7"	3-1/2"	Zinc	0.87 lbs.	10



# METAL BUILDING CLIPS / ANCHOR PLATES

## Purlin Clips (Blank, No Holes)

Item #	Size (Length x Width)	Thickness	Finish	Wt. lbs.	Qty.
#80411 #45911	5" x 3"	10ga	Bare	0.58 lbs.	50 / box 500 / pallet
#80141	5" x 3"	3/16"	Bare	0.78 lbs.	40
#80809	7" x 5"	10ga	Bare	1.36 lbs.	10
#80412 #45912	7" x 5"	3/16"	Bare	1.95 lbs.	10 / box 500 / pallet
#80248	8-1/2" x 3"	3/16"	Bare	2.00 lbs.	10



## Purlin Angle Clip

Item #	Size (Length x Width x Height)	Thickness	Finish	Wt. lbs.	Qty.
#80055	2-3/4" x 2" x 2"	10ga	Bare	0.37 lbs.	12

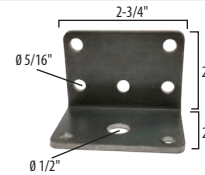

## Purlin Chairs

Item #	Fits Size (Purlin)	Size (Length x Width x Height)	Thickness	Finish	Wt. lbs.	Qty.
#80053	1-1/2"	3" x 1-3/4" x 4-1/2"	10ga	Bare	0.65 lbs.	12
#80054	2"	3" x 2-5/16" x 4-1/2"	10ga	Bare	0.76 lbs.	12

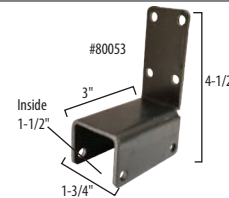

## Headed Weld Studs

Item #	Size	Pin Diameter	Head Size	Finish	Wt. lbs.	Qty.
#50058	4-1/8"	1/2"	1"	Bare	0.20 lbs.	50
#50059	6-1/8"	1/2"	1"	Bare	0.35 lbs.	50
#50511	8-3/16"	1/2"	1"	Bare	0.45 lbs.	100



## Concrete J-Bolt Anchor Plates

Item #	Size (Square Plate)	Plate Thickness	Stud Number	Finish	Wt. lbs.	Qty.
#80082	4" x 4"	3/16"	2	Bare	2.21 lbs.	1
#49717	6" x 6"	3/16"	4	Bare	2.92 lbs.	1
#50585	6" x 6"	3/8"	4	Bare	4.65 lbs.	1
#80083	8" x 8"	3/8"	4	Bare	12.87 lbs.	1
#80084	6" x 12"	3/8"	6	Bare	20.28 lbs.	1



## Concrete Weld Stud Anchor Plates

Item #	Size (Square Plate)	Plate Thickness	Studs	Stud Number	Finish	Wt. lbs.	Qty.
#50388	6" x 6"	3/8"	1/2" x 4-1/8"	4	Bare	4.90 lbs.	1
#49718	6" x 6"	3/8"	1/2" x 6"	4	Bare	5.35 lbs.	1
#49720	6" x 10"	3/8"	1/2" x 6"	4	Bare	7.90 lbs.	1
#49724	8" x 8"	3/8"	1/2" x 6"	4	Bare	8.82 lbs.	1
#49725	10" x 10"	3/8"	1/2" x 6"	4	Bare	12.2 lbs.	1



Item #	Size (Square Plate)	Plate Thickness	Studs	Stud Number	Finish	Wt. lbs.	Qty.
#49719	6" x 10"	3/8"	1/2" x 6"	6	Bare	7.90 lbs.	1
#49721	6" x 12"	3/8"	1/2" x 6"	6	Bare	9.90 lbs.	1
#49722	6" x 14"	3/8"	1/2" x 6"	6	Bare	10.90 lbs.	1
#49726	6" x 14"	1/2"	1/2" x 8"	6	Bare	14.90 lbs.	1
#49723	8" x 12"	3/8"	1/2" x 6"	6	Bare	13.50 lbs.	1
#49727	10" x 10"	1/2"	1/2" x 6"	6	Bare	16.60 lbs.	1



Specifications are subject to change without notice.



**Base Punch Plates**

Item #	Square	Hole (Suits bolt size)	Thickness	Finish	Wt. lbs.	Qty.
#49116	3"	3/8"	3/16"	Bare	0.40 lbs.	20
#49113	4"	3/8"	3/16"	Bare	0.74 lbs.	20
#50250	4"	7/16"	3/16"	Bare	0.73 lbs.	50
#50326	5"	3/8"	3/16"	Bare	1.30 lbs.	10
#50278	5"	3/8"	1/4"	Bare	1.60 lbs.	10
#50318	5"	1/2"	1/4"	Bare	1.57 lbs.	25
#49842	6"	1/2"	1/4"	Bare	2.09 lbs.	10
#49840	8"	9/16"	1/4"	Bare	4.38 lbs.	10
#80066	8"	9/16"	3/8"	Bare	6.70 lbs.	5
#80476	10"	9/16"	5/16"	Bare	9.63 lbs.	8

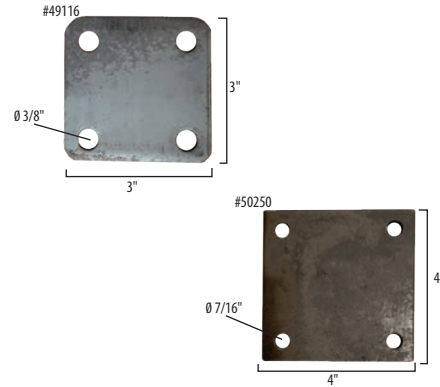

**Anchor Bolts With Washers And Nuts**

Item #	Size (Diameter x Length)	Style	Pintle	Finish	Wt. lbs.	Qty.
#48461	1/2" x 8"	2" Thread - 3 nuts/1 washer	2"	HDG	0.63 lbs.	20
#50570	5/8" x 12"	4" Thread - 2 nuts/2 washers	2"	Bare	1.20 lbs.	20
#48462	3/4" x 12"	4" Thread - 2 nuts/2 washers	3"	HDG	1.88 lbs.	20
#48463	3/4" x 12"	4" Thread - 2 nuts/2 washers	3"	Bare	1.82 lbs.	20
#80131	3/4" x 18"	4" Thread - 2 nuts/2 washers	3"	Bare	2.55 lbs.	10
#80132	3/4" x 24"	4" Thread - 2 nuts/2 washers	3"	Bare	3.20 lbs.	10



**Square Anchor Sleeves**

Item #	Size (Fits Into)	Gauge	Finish	Wt. lbs.	Qty.
#80457	3"	14ga, 11ga	Painted	4.20 lbs.	1
#80235	4"	14ga	Painted	6.30 lbs.	1
#80803	4"	11ga	Painted	6.81 lbs.	1



*Retailer, Wholesaler, or Manufacturer,  
We've got you covered!  
Call us today to set up an account!  
1-866-651-6702*

Item #	Size (Length x Width)	Thickness	Finish	Wt. lbs.	Qty.
#49196	40" x 11"	1/8"	Bare	22.20 lbs.	1

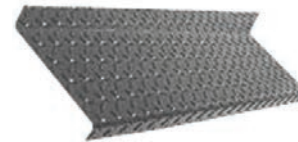

**Outlet Adapter**

Item #	Size (Fits Into)	Finish	Wt. lbs.	Qty.
<i>New</i> #81428	7/8" to 1-1/4"	Powder Coated	0.38 lbs.	50



# WELDING WELDING HELMETS / ACCESSORIES

## Auto-Darkening Welding Helmets

Item #	Type	Wt. lbs.	Qty.
#49965	Black	2.50 lbs.	4
#49966	Skull and Flames	2.50 lbs.	4
#49967	Spider	2.50 lbs.	4
#49968	Flag	2.50 lbs.	4
#50105	Camo	2.50 lbs.	4
#70254	Red/Black	2.50 lbs.	4



## Auto-Darkening Welding Helmets - Wide View

Item #	Type	Wt. lbs.	Qty.
#70281	Black	2.50 lbs.	4
#70282	Red/Silver	2.50 lbs.	4



*New*

## Sugar Scoop Welding Helmets

Item #	Type	Wt. lbs.	Qty.
#81098	Original	2.02 lbs.	1
#81099	Flip Front	1.99 lbs.	1



*We strive to offer great products, selection  
and service at competitive prices.*

## Welding Beanie/Cap

Item #	Type	Wt. lbs.	Qty.
#70255	Navy	0.08 lbs.	10



## Lightweight Safety Glasses

Item #	Wt. lbs.	Qty.
#70190	0.07 lbs.	6



## Welding Helmet Shades - #10

Item #	Size (Width x Length)	Wt. lbs.	Qty.
#70043	2" x 4-1/4"	0.10 lbs.	5
#70045	4-1/2" x 5-1/4"	0.35 lbs.	5



## Armour Guard-SEER Shades

Item #	Size (Width x Length)	Fixed Shade	Wt. lbs.	Qty.
#80187	2" x 4-1/4"	9	0.14 lbs.	1
#80188	2" x 4-1/4"	10	0.14 lbs.	1
#80189	2" x 4-1/4"	11	0.14 lbs.	1



## Welding Helmet Replacement Lens

Item #	Size (Length x Width)	Fits Style	Wt. lbs.	Qty.
#70044	4" x 1-7/8"	All Styles (Inside)	0.10 lbs.	5
#50106	4-5/16" x 3-1/2"	#49965 & #49967 (Outside)	0.15 lbs.	5
#70252	4-5/8" x 3-3/4"	#49966, #49968 & #50105, #70254 (Outside)	0.17 lbs.	5
#70279	5-7/16" x 4-13/16"	Wide View	0.25 lbs.	5



\*Perfect for cutting to suit hard to find sizes

## Welding Helmet Replacement Headgear And Sweatband

Item #	Type	Fits Style	Wt. lbs.	Qty.
#50107	Headgear and Sweatband	Standard	0.34 lbs.	50
#50191	Sweatband	Standard	0.09 lbs.	5
#70284	Headgear and Sweatband	Wide View	0.34 lbs.	50



## Abrasive Display

**Our abrasive display is a perfect addition for your showroom!**

**This display comes with a wide selection of our abrasives. Everything your customer needs!**

Contact a sales representative today for more details.

# WELDING WELDING ACCESSORIES

## Cable Connectors

Item #	Type	Wt. lbs.	Qty.
#70160	300 AMP	0.63 lbs.	50
#70161	500 AMP	0.75 lbs.	35



## Welding Electrode Holders

Item #	Type	Wt. lbs.	Qty.
#70163	300 AMP	0.71 lbs.	50
#70211	600 AMP	1.10 lbs.	30



## Ground Clamp - Brass Alloy

Item #	Type	Wt. lbs.	Qty.
#70173	500 AMP	1.30 lbs.	12



## Steel Ground Clamps Heavy-Duty

Item #	Type	Wt. lbs.	Qty.
#70174	300 AMP	0.49 lbs.	50
#70175	500 AMP	1.00 lbs.	30



## 4" Magnet Ground Clamp

Item #	Type	Wt. lbs.	Qty.
#70247	500 AMP	1.13 lbs.	18



## Single Flint Strikers

Item #	Type	Wt. lbs.	Qty.
#70030	Striker	0.15 lbs.	10
#70031	Renewal (5/pk)	0.01 lbs.	10
#70187	Striker and Renewal (5/pk)	0.20 lbs.	10



## Tri-Flint Strikers

Item #	Type	Wt. lbs.	Qty.
#70032	Striker	0.22 lbs.	25
#70188	Renewal	0.01 lbs.	10



## Flat Soapstones And Holder

Item #	Type	Wt. lbs.	Qty.
#70024	Holder with Soapstone	0.13 lbs.	12
#70025	Replacement Soapstones (6/pk)	0.33 lbs.	100
#70199	Replacement Soapstones (144/pk)	6.65 lbs.	12



## Round Soapstones And Holder

Item #	Type	Wt. lbs.	Qty.
#70196	Holder with Soapstone	0.08 lbs.	10
#70195	Replacement Soapstones (6/pk)	0.17 lbs.	12
#70200	Replacement Soapstones (144/pk)	3.70 lbs.	12





## Mig Welding Pliers

Item #	Wt. lbs.	Qty.
#70026	0.64 lbs.	4



## Multi-Purpose Welding Magnets

Item #	Size	Wt. lbs.	Qty.
#70226	Small - 3"	0.38 lbs.	6
#70056	Medium - 4-1/2"	0.75 lbs.	10
#70193	Large - 6"	1.65 lbs.	6
#70194	Extra Large - 7-1/2"	2.75 lbs.	20

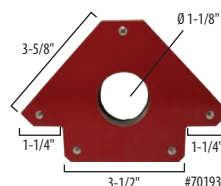

## Universal Tank Wrench

Item #	Finish	Wt. lbs.	Qty.
#70023	Powder Coat	0.72 lbs.	5



## Chipping Hammers

Item #	Style	Finish	Wt. lbs.	Qty.
#70162	Cross Chisel	Powder Coat	1.10 lbs.	10
#70022	Hatchet	Powder Coat	0.86 lbs.	10
#70246	Hatchet with Brush	Powder Coat	1.46 lbs.	10



## 8" Wire Brushes - Toothbrush

Item #	Type	Row Pattern	Wt. lbs.	Qty.
#70034	Stainless Steel	3 x 7	0.04 lbs.	12
#70036	Brass	3 x 7	0.04 lbs.	12



Stainless Steel



Brass

## 8-5/8" Wire Brushes - Curved

Item #	Type	Row Pattern	Wt. lbs.	Qty.
#70035	Stainless Steel	2 x 9	0.08 lbs.	12
#70037	Brass	2 x 9	0.08 lbs.	12



Stainless Steel



Brass

## 10" Shoe Handle Wire Brush

Item #	Type	Row Pattern	Wt. lbs.	Qty.
#70039	Carbon	4 x 16	0.29 lbs.	12



## 13" Wooden Handle Angled Wire Brush

Item #	Type	Row Pattern	Wt. lbs.	Qty.
#70272	Carbon	3 x 14	0.38 lbs.	12



## 14" Wooden Handle Wire Brushes

Item #	Type	Row Pattern	Wt. lbs.	Qty.
#70038	Carbon	3 x 19	0.33 lbs.	15
#70040	Stainless Steel	3 x 19	0.25 lbs.	12



Stainless Steel



Carbon

**Victor® Style Cutting Tips**

**Oxy-Acetylene**

Item #	Type	Wt. lbs.
#70228	1-101-000 Victor® Style Cutting Tip	0.13 lbs.
#70229	1-101-00 Victor® Style Cutting Tip	0.07 lbs.
#70227	1-101-0 Victor® Style Cutting Tip	0.07 lbs.
#70059	1-101-1 Victor® Style Cutting Tip	0.20 lbs.
#70060	1-101-2 Victor® Style Cutting Tip	0.19 lbs.
#70230	1-101-3 Victor® Style Cutting Tip	0.19 lbs.
#70231	3-101-000 Victor® Style Cutting Tip	0.13 lbs.
#70184	3-101-00 Victor® Style Cutting Tip	0.07 lbs.
#70057	3-101-0 Victor® Style Cutting Tip	0.13 lbs.
#70058	3-101-1 Victor® Style Cutting Tip	0.07 lbs.
#70185	3-101-2 Victor® Style Cutting Tip	0.19 lbs.
#70186	3-101-3 Victor® Style Cutting Tip	0.19 lbs.



**Natural Gas or Propane**

Item #	Type	Wt. lbs.
#70234	GPN-000 Victor® Style Cutting Tip	0.13 lbs.
#70235	GPN-00 Victor® Style Cutting Tip	0.13 lbs.
#70232	GPN-0 Victor® Style Cutting Tip	0.13 lbs.
#70233	GPN-1 Victor® Style Cutting Tip	0.19 lbs.
#70236	GPN-2 Victor® Style Cutting Tip	0.19 lbs.
#70237	GPN-3 Victor® Style Cutting Tip	0.19 lbs.
#70238	GPN-4 Victor® Style Cutting Tip	0.19 lbs.
#70239	3GPN-00 Victor® Style Cutting Tip	0.13 lbs.
#70240	3GPN-0 Victor® Style Cutting Tip	0.13 lbs.
#70241	3GPN-1 Victor® Style Cutting Tip	0.19 lbs.
#70242	3GPN-2 Victor® Style Cutting Tip	0.19 lbs.
#70243	3GPN-3 Victor® Style Cutting Tip	0.19 lbs.
#70244	3GPN-4 Victor® Style Cutting Tip	0.19 lbs.



**Gas Couplers**

Item #	Gas Type	Size	Wt. lbs.	Qty.
#80375	Oxygen	30	0.06 lbs.	1
#80376	Acetylene	31	0.06 lbs.	1



**Quick-Connects Set**

Item #	Style	Wt. lbs.	Qty.
#80377	Torch to Hose	7.97 lbs.	1
#80378	Regulator to Hose	11.57 lbs.	1



**Flashback Arrestor Set**

Item #	Wt. lbs.	Qty.
#70183	0.61 lbs.	48



**5/8" Bore Tweco® Style With Mig Nozzle**

Item #	Fits Welders	Wt. lbs.	Qty.
#70053	125 / 135 / 175	0.17 lbs.	12



**Contact Tips - 5/Pack**

Item #	Style	Wt. lbs.	Qty.
#70050	.025"	0.08 lbs.	12
#70051	.030"	0.08 lbs.	12
#70052	.035"	0.08 lbs.	20



**Twin Welding Oxygen - Acetylene Hoses**

Item #	Size	Wt. lbs.	Qty.
#80374	3/16" x 50'	7.97 lbs.	1 *
#70063	1/4" x 25'	5.50 lbs.	4
#70280	1/4" x 50'	12.02 lbs.	1
#80373	1/4" x 50'	11.57 lbs.	1 *
#81064	1/4" x 100'	23.70 lbs.	1 *



## 21" Victor® Style Hand Cutting Torch

Item #	Wt. lbs.	Qty.
#70256	3.56 lbs.	1



## Cutting Attachment

Item #	Style	Length	Wt. lbs.	Qty.
#70267	Medium-Duty	8"	1.00 lbs.	1
#70268	Heavy-Duty Series 1	10-1/2"	2.09 lbs.	1

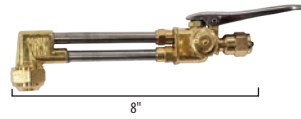

## Torch Handle Attachments

Item #	Style	Length	Wt. lbs.	Qty.
#70269	Light/Medium-Duty	9"	1.06 lbs.	1
#70270	Medium/Heavy-Duty	9-1/2"	1.50 lbs.	1



## Victor Style Heating Assembly

Item #	Wt. lbs.	Qty.
<i>New</i> #81149	0.91 lbs.	1



## Acetylene Regulators

Item #	Style	Wt. lbs.	Qty.
#70258	(A) 250 Series	2.86 lbs.	1
#70260	(B) 350 Series	2.20 lbs.	1
#70264	(C) 450 Series	3.30 lbs.	1

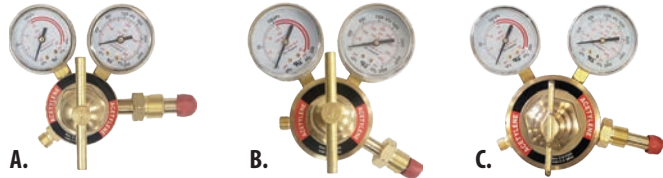

## Nitrogen Regulator

Item #	Style	Wt. lbs.	Qty.
#70262	350 Series	2.20 lbs.	1



## Oxygen Regulators

Item #	Style	Wt. lbs.	Qty.
#70259	(A) 250 Series	2.86 lbs.	1
#70261	(B) 350 Series	2.20 lbs.	1
#70265	(C) 450 Series	3.30 lbs.	1

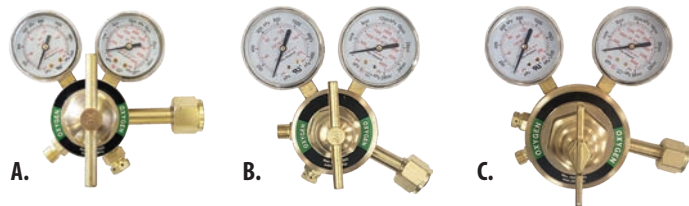

## Flow-Meter Regulator

Item #	Wt. lbs.	Qty.
#70257	1.98 lbs.	1



## Standard Tip Cleaner Set

Item #	Finish	Wt. lbs.	Qty.
#70033	Stainless Steel	0.03 lbs.	12



**Torch Outfit Kits**

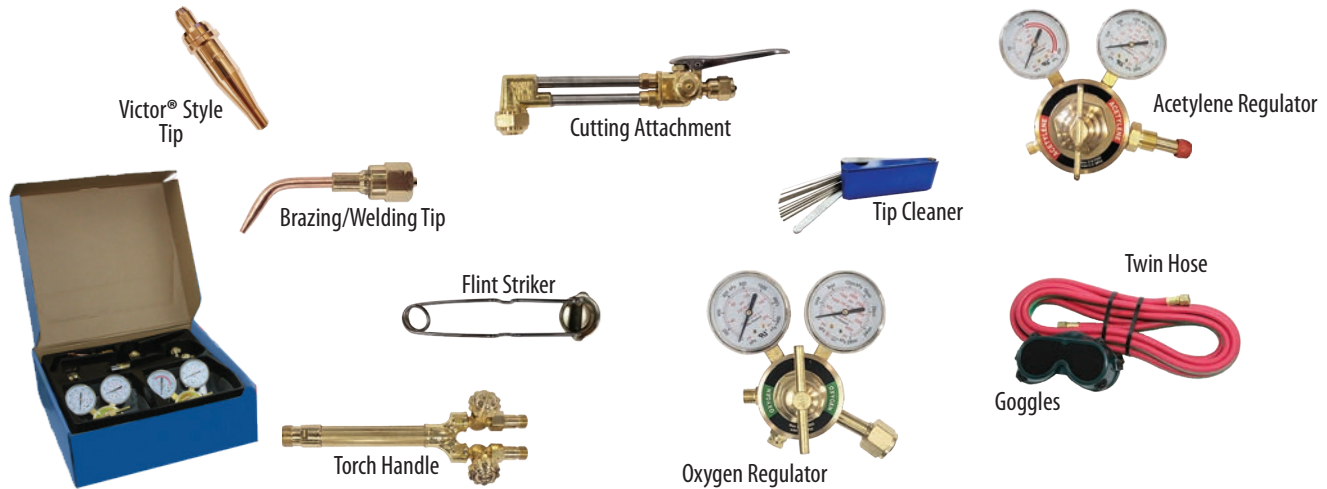

Item #	Style	Includes	Wt. lbs.	Qty.
#70263	350 Series	<ul style="list-style-type: none"> <li>• 12' x 1/4" R-Grade Twin Hose</li> <li>• Standard Goggles</li> <li>• Standard Tip Cleaner</li> <li>• Medium Cutting Attachment</li> <li>• Victor Style Brazing/Welding Assembly W#2</li> <li>• 0-1-101 Size 1 Victor Style Acetylene Cutting Tip</li> <li>• Flint Striker</li> <li>• Medium-duty Torch Handle</li> <li>• 350 Series Acetylene Regulator CGA-510</li> <li>• 350 Series Oxygen Regulator CGA-540</li> </ul>	16.19 lbs.	1
#70266	450 Series	<ul style="list-style-type: none"> <li>• 12' x 1/4" R-Grade Twin Hose</li> <li>• Standard Goggles</li> <li>• Standard Tip Cleaner</li> <li>• Medium Cutting Attachment</li> <li>• Victor Style Brazing/Welding Assembly W#2</li> <li>• 0-1-101 Size 1 Victor Style Acetylene Cutting Tip</li> <li>• Flint Striker</li> <li>• Medium-duty Torch Handle</li> <li>• 450 Series Acetylene Regulator CGA-510</li> <li>• 450 Series Oxygen Regulator CGA-540</li> </ul>	22.00 lbs.	1



**Cut-to-Length Display**



Our Cut-to-Length displays are designed to allow you to mix and match products to suit your needs.

All of our materials are deburred, cleaned, labeled, and color-coded.

Contact your sales representative today for more information!





**Welding Rods**

Alloy	Size	5# Box	10# Box	50# Box	Amperage
6010	1/8"	#70250	#70182	#81652	65-130 AMP
	5/32"	#48576	#70253	-	130-180 AMP
6011	3/32"	#70066	#47666	-	20-75 AMP
	1/8"	#70067	#70164	#70165	75-130 AMP
	5/32"	#70167	#70166	#70168	130-180 AMP
6013	3/32"	#70072	#48534	-	20-75 AMP
	1/8"	#70073	#70169	-	75-130 AMP
	5/32"	-	#48535	-	130-180 AMP
7014	1/8"	-	#48540	-	65-130 AMP
7018	3/32"	#70074	-	-	20-75 AMP
	1/8"	#70075	#70170	#70171	75-130 AMP
	5/32"	-	#48553	#70172	75-130 AMP



**E6010 Arc Welding Rods**

- All position electrode
- Carbon and galvanized steel
- DC Welder and DCEP

**E6013 Arc Welding Rods**

- Mild steel, all purpose, all position electrode
- Best on clean, new metal
- Easy start at low amperage
- Suits AC or DC Machines

**E6011 Arc Welding Rods**

- All purpose, all position
- Great on rusty, dirty metal, and poor fit ups
- Designed for repair and maintenance
- Suits AC or DC Machines

**E7018 Arc Welding Rods**

- Low hydrogen
- Cold rolled steel, high carbon steel, and sulphur steel
- Joins hard to weld steels easily
- Vertical, flat, and fillet welding
- Suits AC or DC Machines

Other Items Available Upon Request



*We want to see your  
DIY projects!  
Send us a photo at  
[sales@springcreekproducts.com](mailto:sales@springcreekproducts.com)  
to strut your stuff, and we will  
send you a free  
Spring Creek™ Products Cap!*

*Check out page 102 for ideas!*

**Welding Wire**

Alloy	Size	2# Roll	10# Roll	11# Roll	33# Roll
Mig Wire (No Flux)	.030"	-	-	#70176	-
	.035"	-	-	#70177	#70178
	.045"	-	-	-	#70179
Flux Wire	.030"	#70080	#70180	-	-
	.035"	#70081	#70181	-	-



# Total Cut®

## Pipe Guides

"Precision Cutting Made Simple"

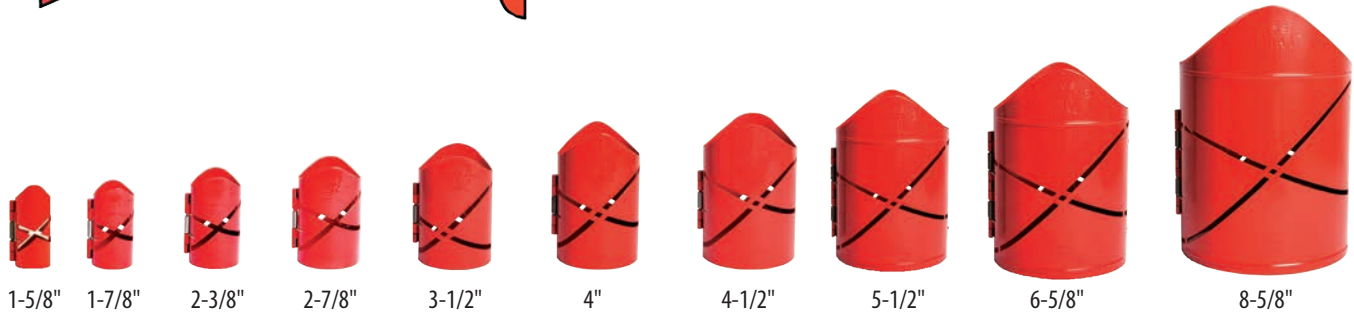

### A Fabricators Best Friend!

Clamps onto pipe with heavy-duty spring, allowing you to mark precisely.  
No magnets to collect metal shavings in your tool box. It doesn't get any easier!

Item #	Size	Finish	Wt. lbs.	QTY (Pieces per case)
#47937	1-5/8"	Powder Coat	0.37 lbs.	12
#47022	1-7/8"	Powder Coat	0.40 lbs.	12
#47023	2-3/8"	Powder Coat	0.55 lbs.	12
#47024	2-7/8"	Powder Coat	0.71 lbs.	12
#47025	3-1/2"	Powder Coat	0.85 lbs.	6
#47716	4"	Powder Coat	1.40 lbs.	6
#47026	4-1/2"	Powder Coat	1.38 lbs.	6
#50131	5-1/2"	Powder Coat	2.25 lbs.	6
#47717	6-5/8"	Powder Coat	3.13 lbs.	6
#47718	8-5/8"	Powder Coat	5.75 lbs.	6
#80968	Kit	Powder Coat	1.66 lbs.	6

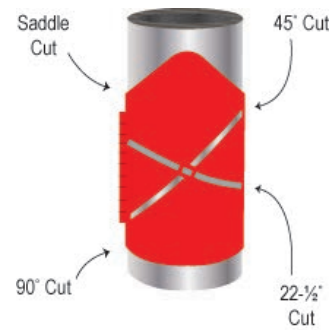

*Now Available!*

Pipe Guide Kit: 1-7/8", 2-3/8", and 2-7/8"

#### Saddle Series Cutting Guide

Item #	Size	Finish	Wt. lbs.	Qty.
#70275	2-3/8"	Powder Coat	0.38 lbs.	12
<i>New</i> #70276	2-7/8"	Powder Coat	0.56 lbs.	12

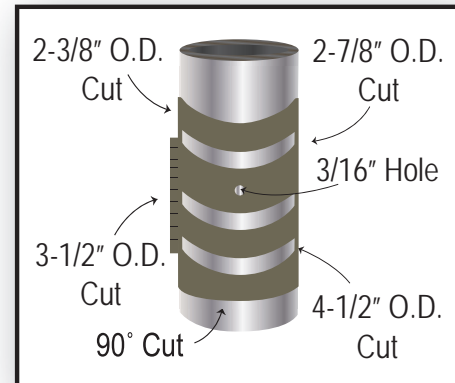

### Round Plates - For Round Tubing

Item #	Outside Diameter	Fits Over	Thickness	Finish	Wt. lbs.	Qty.
#80615	3-1/8"	1.05" O.D.	12ga	Bare	0.19 lbs.	50
#80616	3-1/4"	1-1/4" O.D.	12ga	Bare	0.21 lbs.	49
#80617	3-3/8"	1.315" O.D.	12ga	Bare	0.22 lbs.	50
#80618	3-1/2"	1-1/2" O.D.	12ga	Bare	0.23 lbs.	50
#80619	3-3/4"	1.66" O.D.	12ga	Bare	0.26 lbs.	10
#80620	4"	1.90" O.D.	3/16"	Bare	0.51 lbs.	10
#80621	4-3/8"	2-3/8" O.D.	3/16"	Bare	0.55 lbs.	10
#80622			1/4"	Bare	0.74 lbs.	10
#80623	5-5/8"	2-7/8" O.D.	3/16"	Bare	0.96 lbs.	10
#80624			1/4"	Bare	1.33 lbs.	10

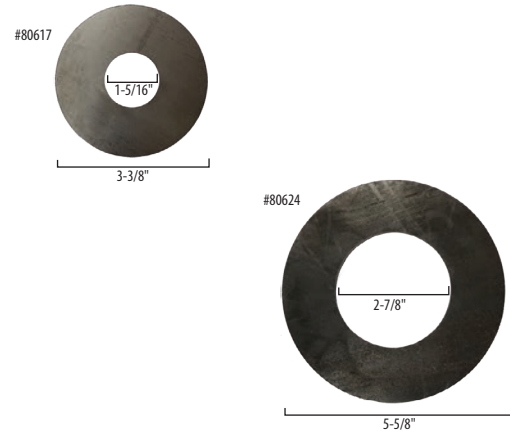

### Round Plates With 3 Holes - For Round Tubing

Item #	Outside Diameter	Fits Over	Hole Size	Thickness	Finish	Wt. lbs.	Qty.
#80517	3-1/8"	1.05" O.D.	0.26"	12ga	Bare	0.19 lbs.	50
#80518	3-1/4"	1-1/4" O.D.	0.26"	12ga	Bare	0.21 lbs.	30
#80519	3-3/8"	1.315" O.D.	0.26"	12ga	Bare	0.22 lbs.	50
#80520	3-1/2"	1-1/2" O.D.	0.316"	12ga	Bare	0.22 lbs.	40
#80521	3-3/4"	1.66" O.D.	0.316"	12ga	Bare	0.24 lbs.	50
#80522	4"	1.90" O.D.	0.316"	3/16"	Bare	0.49 lbs.	10
#80523	4-3/8"	2-3/8" O.D.	0.316"	3/16"	Bare	0.53 lbs.	10
#80524			0.380"	1/4"	Bare	0.66 lbs.	10
#80525	5-5/8"	2-7/8" O.D.	0.380"	3/16"	Bare	0.95 lbs.	10
#80526			1/4"	Bare	1.18 lbs.	10	

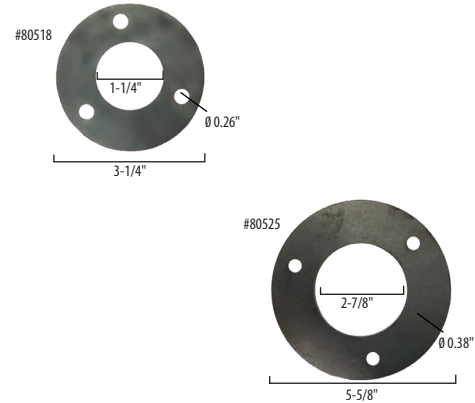

***Sign Up To Order Online!***



It's simple and easy! Place orders, view product information, prices, and invoices.

Contact your sales representative for more information at 866-651-6702

***Check out our website: [www.springcreekproducts.com](http://www.springcreekproducts.com)***

### Round Plates With 4 Holes - For Round Tubing

Item #	Outside Diameter	Fits Over	Hole Size	Thickness	Finish	Wt. lbs.	Qty.
#80527	3-3/4"	1.66" O.D.	0.40"	1/4"	Bare	0.59 lbs.	10
#80528	4"	1.90" O.D.	0.40"	1/4"	Bare	0.61 lbs.	10
#80529	4-3/8"	2-3/8" O.D.	0.40"	1/4"	Bare	0.66 lbs.	10
#80530	5-5/8"	2-7/8" O.D.	0.56"	1/4"	Bare	1.14 lbs.	10
#80531	6-1/4"	3-1/2" O.D.	0.56"	3/8"	Bare	2.07 lbs.	10
#80532	7-1/4"	4-1/2" O.D.	0.56"	3/8"	Bare	2.55 lbs.	10

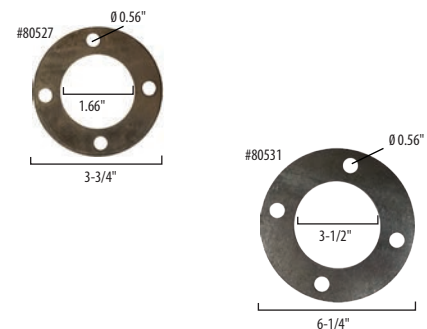

# WELDING WELDING PLATES

## Triangular Plates - Unequal Sides

Item #	Size	Thickness	Finish	Wt. lbs.	Qty.
#80546	1" x 1-13/16"	12ga	Bare	0.02 lbs.	200
#80547	1-1/2" x 2-3/4"	3/16"	Bare	0.12 lbs.	200
#80548	2" x 3-3/4"	3/16"	Bare	0.21 lbs.	100
#80549		1/4"	Bare	0.26 lbs.	100
#80550	2-1/2" x 4-3/4"	1/4"	Bare	0.43 lbs.	40
#80551		3/8"	Bare	0.65 lbs.	40
#80552	3" x 5-3/4"	1/4"	Bare	0.64 lbs.	40
#80553		3/8"	Bare	0.95 lbs.	10
#80554	4" x 7-3/4"	1/4"	Bare	1.08 lbs.	20
#80555		3/8"	Bare	1.69 lbs.	10

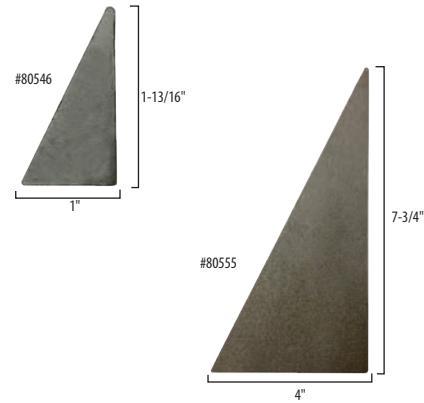

## Triangular Plates - Unequal Sides With Weld Notch

Item #	Size	Thickness	Finish	Wt. lbs.	Qty.
#80569	3/4" x 2"	12ga	Bare	0.02 lbs.	200
#80570	1-1/4" x 2-1/2"	3/16"	Bare	0.12 lbs.	100
#80571	1-3/4" x 4"	3/16"	Bare	0.21 lbs.	50
#80572		1/4"	Bare	0.27 lbs.	40
#80573	2-1/4" x 4-1/2"	1/4"	Bare	0.44 lbs.	40
#80574		3/8"	Bare	0.65 lbs.	40
#80575	2-3/4" x 5-1/2"	1/4"	Bare	0.64 lbs.	40
#80576		3/8"	Bare	0.92 lbs.	10
#80577	3-1/2" x 7-1/2"	1/4"	Bare	1.13 lbs.	20
#80578		3/8"	Bare	1.67 lbs.	10

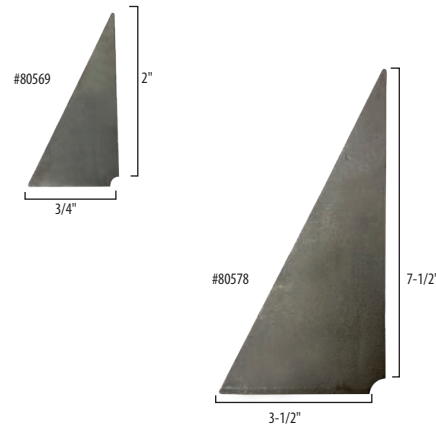

# \$1,000+ Orders Ship For Free!!!



Call your sales representative  
today to see if you qualify!  
**1-866-651-6702**

*Some exclusions apply, offer subject to change without notice.*

*New*

## Gussets

Item #	Type	Size (Diagonal x Base x Height)	Thickness	Finish	Wt. lbs.	Qty.
#81118	(A) 4-Sided With Hole	6-7/8" x 3" x 4"	1/4"	Bare	0.58 lbs.	50
#81120	(B) 4-Sided	5-1/4" x 3-3/16" x 2-13/16"	1/4"	Bare	0.46 lbs.	50
#81119	(C) 5-Sided	3-3/16" x 1-3/8" x 2-3/4"	1/4"	Bare	0.22 lbs.	70

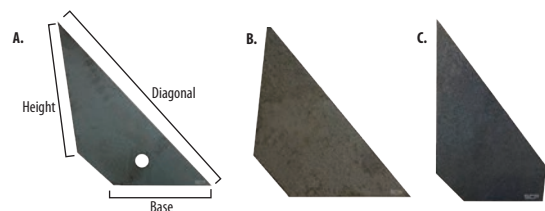



## Gusset Triangle Plates

Item #	Size (Height x Hypotenuse)	Thickness	Finish	Wt. lbs.	Qty.
#49847	2" x 2-3/4"	3/8"	Bare	0.20 lbs.	200
#50023	5-11/16" x 7-7/8"	1/4"	Bare	1.20 lbs.	25

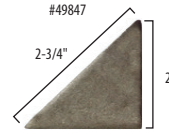

## Triangular Plates - Equal Sides

Item #	Size	Thickness	Finish	Wt. lbs.	Qty.
#80533	2"	3/16"	Bare	0.01 lbs.	50
#80534	2-1/2"	3/16"	Bare	0.16 lbs.	50
#80535	3"	3/16"	Bare	0.24 lbs.	40
#80536		1/4"	Bare	0.31 lbs.	50
#80537	3-1/2"	1/4"	Bare	0.43 lbs.	50
<i>New</i> #81121	4"	1/8"	Bare	0.24 lbs.	100
<i>New</i> #81122		3/16"	Bare	0.39 lbs.	40
#80538		1/4"	Bare	0.58 lbs.	40
#80539	4-1/2"	1/4"	Bare	0.74 lbs.	10
#80540	5"	1/4"	Bare	0.91 lbs.	10
#80541	5-1/2"	1/4"	Bare	1.03 lbs.	10
<i>New</i> #81123	6"	1/8"	Bare	0.52 lbs.	40
<i>New</i> #81124		3/16"	Bare	0.94 lbs.	25
#80542		1/4"	Bare	1.21 lbs.	10
#80543		3/8"	Bare	1.90 lbs.	10
<i>New</i> #81125	8"	1/8"	Bare	0.92 lbs.	40
<i>New</i> #81126		3/16"	Bare	1.61 lbs.	25
#80544		1/4"	Bare	2.18 lbs.	10
#80545		3/8"	Bare	3.39 lbs.	10

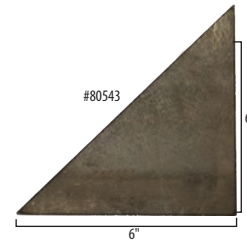

*If you need help with an order, have questions about our products,  
or have an inquiry about setting up an account,  
please contact a member of our team today!*

*We would love to hear from you!  
1-866-651-6702 or [sales@springcreekproducts.com](mailto:sales@springcreekproducts.com)*

## Triangular Plates - Equal Sides With Weld Notch

Item #	Size	Thickness	Finish	Wt. lbs.	Qty.
#80556	2"	3/16"	Bare	0.10 lbs.	50
#80557	2-1/2"	3/16"	Bare	0.16 lbs.	50
#80558	3"	3/16"	Bare	0.23 lbs.	50
#80559		1/4"	Bare	0.28 lbs.	50
#80560	3-1/2"	1/4"	Bare	0.42 lbs.	50
#80561	4"	1/4"	Bare	0.49 lbs.	50
#80562	4-1/2"	1/4"	Bare	0.73 lbs.	10
#80563	5"	1/4"	Bare	0.90 lbs.	10
#80564	5-1/2"	1/4"	Bare	1.01 lbs.	10
#80565	6"	1/4"	Bare	1.14 lbs.	10
#80566		3/8"	Bare	1.88 lbs.	10
#80567	8"	1/4"	Bare	2.18 lbs.	10
#80568		3/8"	Bare	3.38 lbs.	10

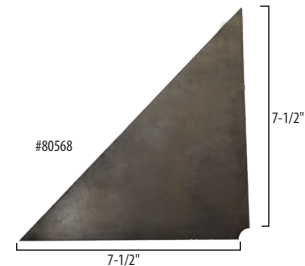

## Square Plates - For Round Tubing

Item #	Outside Square	Fits Over	Thickness	Finish	Wt. lbs.	Qty.
#80601	3"	1.05" O.D.	3/16"	Bare	0.43 lbs.	50
#80602	4"	1-1/4" O.D.	3/16"	Bare	0.78 lbs.	50
#80603		1.315" O.D.		Bare	0.76 lbs.	50
#80604		1-1/2" O.D.		Bare	0.74 lbs.	50
#80605		1.66" O.D.		Bare	0.73 lbs.	10
#80606		1.90" O.D.		Bare	0.70 lbs.	50
#80607	5"	1.90" O.D.	1/4"	Bare	1.54 lbs.	10
#80608		2-3/8" O.D.		Bare	1.45 lbs.	10
#80609		2-7/8" O.D.		Bare	1.30 lbs.	10
#80610	6"	3-1/2" O.D.	1/4"	Bare	1.85 lbs.	10
#80611		4-1/2" O.D.	1/4"	Bare	1.40 lbs.	10
#80612			3/8"	Bare	2.11 lbs.	10
#80613	8"	6-5/8" O.D.	1/4"	Bare	2.13 lbs.	10
#80614			3/8"	Bare	3.04 lbs.	10

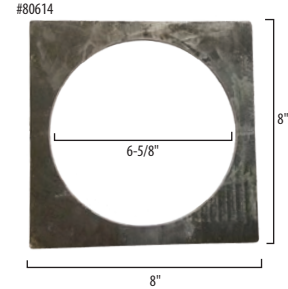
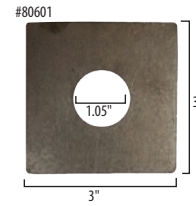

## Glove Display

Our glove display is designed to allow you to mix and match products to suit your needs.

All available items located on page 123 - 124.

Contact your sales representative today for more information!



## Square Plates With Holes - For Round Tubing

Item #	Outside Square	Fits Over	Hole Size	Thickness	Finish	Wt. lbs.	Qty.	
#80503	3"	1.05" O.D.	0.40"	3/16"	Bare	0.40 lbs.	20	
#80504	4"	1-1/4" O.D.	0.40"	3/16"	Bare	0.76 lbs.	20	
#80505		1.315" O.D.		3/16"	Bare	0.73 lbs.	10	
#80506		1-1/2" O.D.		3/16"	Bare	0.73 lbs.	20	
#80507		1.66" O.D.		3/16"	Bare	0.71 lbs.	10	
#80508		1.90" O.D.		3/16"	Bare	0.66 lbs.	10	
#80509		5"		1.90" O.D.	0.40"	1/4"	Bare	1.53 lbs.
#80510	2-3/8" O.D.		1/4"	Bare		1.42 lbs.	20	
#80511	2-7/8" O.D.		1/4"	Bare		1.27 lbs.	10	
#80512	3-1/2" O.D.		0.56"	1/4"		Bare	1.74 lbs.	10
#80513	4-1/2" O.D.			1/4"		Bare	1.30 lbs.	10
#80514	6"	4-1/2" O.D.	0.56"	3/8"	Bare	1.98 lbs.	10	
#80515	8"	6-5/8" O.D.	0.63"	1/4"	Bare	1.88 lbs.	10	
#80516				3/8"	Bare	2.85 lbs.	10	

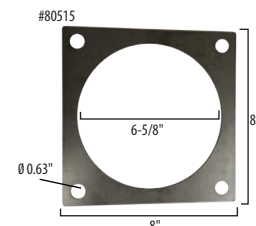
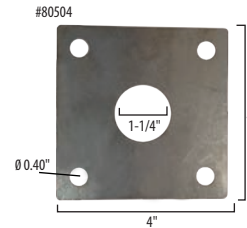

## Square Plates - For Square Tubing

Item #	Outside Square	Fits Over	Thickness	Finish	Wt. lbs.	Qty.	
#80579	3"	1"	3/16"	Bare	0.42 lbs.	20	
#80580	4"	1-1/4"	3/16"	Bare	0.77 lbs.	20	
#80581		1-1/2"	3/16"	Bare	0.73 lbs.	20	
#80587			1/4"	Bare	0.91 lbs.	10	
#80582		2"	3/16"	Bare	0.63 lbs.	20	
#80588			1/4"	Bare	0.78 lbs.	10	
#80583		2-1/2"	3/16"	Bare	0.51 lbs.	50	
#80589			1/4"	Bare	0.64 lbs.	50	
#80584		5"	2"	3/16"	Bare	1.11 lbs.	10
#80590	1/4"			Bare	1.48 lbs.	10	
#80585	2-1/2"		3/16"	Bare	0.98 lbs.	10	
#80591			1/4"	Bare	1.18 lbs.	10	
#80586	3"		3/16"	Bare	0.84 lbs.	10	
#80592			1/4"	Bare	1.11 lbs.	10	
#80593	6"		3"	1/4"	Bare	1.85 lbs.	10
#80595				3/8"	Bare	2.82 lbs.	10
#80594		4"	1/4"	Bare	1.39 lbs.	10	
#80596			3/8"	Bare	2.08 lbs.	10	
#80597	8"	3"	1/4"	Bare	3.84 lbs.	10	
#80599			3/8"	Bare	5.76 lbs.	10	
#80598		4"	1/4"	Bare	3.36 lbs.	10	
#80600			3/8"	Bare	5.06 lbs.	10	

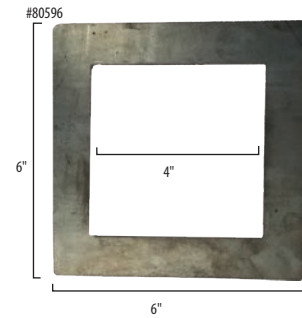
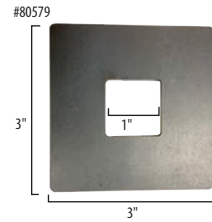

## Square Plates With Holes - For Square Tubing

Item #	Outside Square	Fits Over	Hole Size	Thickness	Finish	Wt. lbs.	Qty.	
#80481	3"	1"	0.40"	3/16"	Bare	0.39 lbs.	50	
#80482	4"	1-1/4"	0.40"	3/16"	Bare	0.74 lbs.	50	
#80483		1-1/2"		3/16"	Bare	0.69 lbs.	50	
#80489				1/4"	Bare	0.86 lbs.	10	
#80484		2"		3/16"	Bare	0.61 lbs.	20	
#80490	1/4"		Bare	0.74 lbs.	10			
#80486	5"	2"	0.40"	3/16"	Bare	1.08 lbs.	10	
#80492			0.56"	1/4"	Bare	1.31 lbs.	10	
#80487		2-1/2"	0.40"	3/16"	Bare	0.96 lbs.	10	
#80493			0.56"	1/4"	Bare	1.15 lbs.	10	
#80488		3"	0.40"	3/16"	Bare	0.81 lbs.	10	
#80494			0.56"	1/4"	Bare	0.97 lbs.	10	
#80495		6"	3"	0.56"	1/4"	Bare	1.69 lbs.	10
#80497				3/8"	Bare	2.73 lbs.	10	
#80499	8"	3"	0.63"	1/4"	Bare	3.56 lbs.	10	
#80501				3/8"	Bare	5.65 lbs.	10	
#80500		4"		1/4"	Bare	3.33 lbs.	10	
#80502				3/8"	Bare	4.94 lbs.	10	

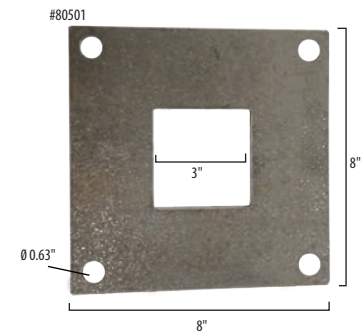
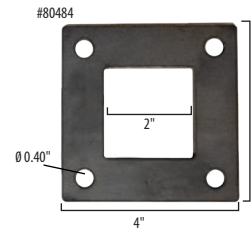

## Square Weld Flanges

Item #	Size (Length x Width)	Thickness	Hole	Finish	Wt. lbs.	Qty.
#49979	4" x 4" (Inner Sq. 1-1/2")	9ga	3/8"	Bare	0.05 lbs.	100
<i>New</i> #81458	5-1/4" x 5-1/4" (Inner Sq. 2")	3/16"	7/16"	Bare	1.16 lbs.	50

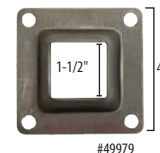

## Welding Tabs

These welding tabs are available in a variety of sizes and styles to fit your needs!

### Single Hole With Rounded Corners

Item #	Size (Height x Width)	Thickness	Hole	Finish	Wt. lbs.	Qty.
#49456	1-1/2" x 1"	1/8"	3/8"	Bare	0.03 lbs.	100
#80379	1-3/4" x 1-7/16"	1/4"	1/2"	Bare	0.14 lbs.	100
#50069	2" x 1-1/4"	3/16"	1/2"	Bare	0.14 lbs.	100
#49455	2-3/8" x 1"	1/8"	3/8"	Bare	0.06 lbs.	100
<i>New</i> #81452	2-3/8" x 2"	3/8"	1-1/8"	Bare	0.34 lbs.	80
#49120	2-3/4" x 1"	3/16"	3/8"	Bare	0.09 lbs.	100
#49121	3-1/2" x 1"	3/16"	3/8"	Bare	0.14 lbs.	100

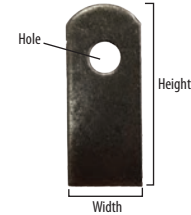

### Single Hole With Square Corners

Item #	Size (Height x Width)	Thickness	Hole	Finish	Wt. lbs.	Qty.
#49124	2-1/2" x 1-1/2"	1/8"	3/8"	Bare	0.09 lbs.	100



### Double Hole

Item #	Size (Height x Width)	Thickness	Hole	Finish	Wt. lbs.	Qty.
#49665	3-1/4" x 1"	3/16"	3/8"	Bare	0.20 lbs.	100
#49926	3-7/8" x 1-1/2"	8ga	3/8"	Bare	0.23 lbs.	180



### Double Hole With Square Corners

Item #	Size (Height x Width)	Thickness	Hole	Finish	Wt. lbs.	Qty.
<i>New</i> #81084	3-7/16" x 1-1/2"	3/16"	3/8"	Bare	0.21 lbs.	100



### Single Oval Hole

Item #	Size (Height x Width)	Thickness	Hole	Finish	Wt. lbs.	Qty.
#49122	2-3/8" x 1"	1/8"	3/4" x 1/4"	Bare	0.05 lbs.	100



*New*

### Square Weld Tabs

Item #	Type	Size (Height x Width)	Thickness	Hole	Finish	Wt. lbs.	Qty.
#81668	(A) Rectangular	7-1/2" x 3"	3/8"	1-1/16"	Bare	2.25 lbs.	20
#81669	(B) Square	2-1/2" x 2-1/2"	3/8"	1-1/16"	Bare	0.50 lbs.	25
#81670	(C) Rounded Square	2-3/4" x 1-1/2"	1/2"	1-1/16"	Bare	0.39 lbs.	70
#81671	(D) Thin Rectangular	3" x 3/8"	3/8"	-	Bare	0.12 lbs.	100

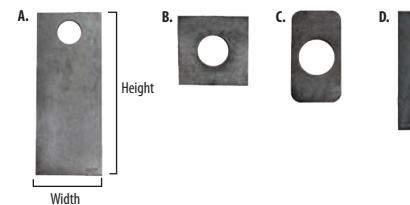



## Single Hole With Side Tabs

Item #	Size (Height x Width)	Thickness	Hole	Finish	Wt. lbs.	Qty.
#49984	2-3/4" x 2"	12ga	3/8"	Bare	0.13 lbs.	230
#49985	3-1/4" x 2"	12ga	3/8"	Bare	0.10 lbs.	200



## Bent Side Tab

Item #	Size (Height x Depth x Width)	Thickness	Hole	Finish	Wt. lbs.	Qty.
#80380	1-13/16" x 1-5/8" x 1"	13ga	3/8"	Bare	0.10 lbs.	100

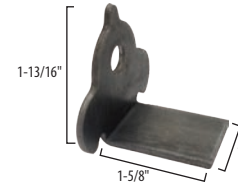

## Single Hole With Bent Tab

Item #	Size (Height x Depth x Width)	Thickness	Hole	Finish	Wt. lbs.	Qty.
#49982	1-1/2" x 1-1/2" x 1-1/2"	9ga	3/8"	Bare	0.16 lbs.	120
#49980	2" x 1-1/2" x 1"	9ga	3/8"	Bare	0.13 lbs.	180
#49981	3-1/8" x 1-1/2" x 1"	9ga	3/8"	Bare	0.16 lbs.	120
#49667	3-1/8" x 1-5/8" x 1-1/4"	3/16"	3/8"	Bare	0.35 lbs.	100
#49983	3-1/2" x 1-1/2" x 1-1/2"	8ga	3/8"	Bare	0.28 lbs.	80

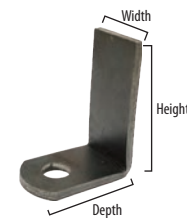

*Looking for additional  
trailer accessories?  
Check out the Trailer Parts  
section on pages 62 - 65.*



## Angle Brackets With Holes

Item #	Size	Hole (Diameter x Number)	Thickness	Finish	Wt. lbs.	Qty.
#49716	(A) 2"	1/4" x 4	1/8"	Bare	0.27 lbs.	60
#50444	(B) 2"	3/16" x 2	1/8"	Powder	0.35 lbs.	25

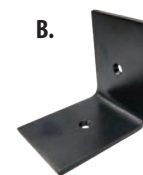
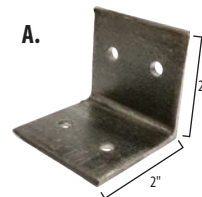

## Angle Brackets

Item #	Size (Length x Width x Height)	Thickness	Finish	Wt. lbs.	Qty.
#47687	3" x 3" x 2"	10ga	Bare	0.43 lbs.	80
#47688	4" x 3" x 4"	10ga	Bare	1.03 lbs.	32
#47689	5" x 3" x 6"	10ga	Bare	1.75 lbs.	20



*New*

## Radius Surface Mount Tabs

Item #	Size (Width x Height)	Hole Diameter	Radius	Fits Tube	Thickness	Finish	Wt. lbs.	Qty.
#81191	1" x 1.15"	0.40"	1/2"	1.05" OD	3/16"	Bare	0.04 lbs.	100
#81192	1" x 1.40"						0.06 lbs.	100
#81193	1" x 1.65"						0.07 lbs.	100
#81194	1" x 1.90"						0.08 lbs.	100
#81195	1" x 2.15"						0.10 lbs.	100
#81196	1" x 2.40"						0.11 lbs.	100
#81197	1" x 1.13"	0.40"	0.63"	1.25" OD	3/16"	Bare	0.04 lbs.	100
#81198	1" x 1.38"						0.06 lbs.	100
#81199	1" x 1.63"						0.07 lbs.	100
#81200	1" x 1.88"						0.08 lbs.	100
#81201	1" x 2.13"						0.10 lbs.	100
#81202	1" x 2.38"						0.11 lbs.	100
#81203	1" x 1.12"	0.40"	0.66"	1.315" OD	3/16"	Bare	0.04 lbs.	100
#81204	1" x 1.37"						0.06 lbs.	100
#81205	1" x 1.62"						0.07 lbs.	100
#81206	1" x 1.87"						0.08 lbs.	100
#81207	1" x 2.12"						0.10 lbs.	100
#81208	1" x 2.37"						0.11 lbs.	100
#81209	1" x 1.10"	0.40"	0.75"	1.50" OD	3/16"	Bare	0.04 lbs.	100
#81210	1" x 1.35"						0.06 lbs.	100
#81211	1" x 1.60"						0.07 lbs.	100
#81212	1" x 1.85"						0.08 lbs.	100
#81213	1" x 2.10"						0.10 lbs.	100
#81214	1" x 2.35"						0.11 lbs.	100
#81215	1" x 1.09"	0.40"	0.83"	1.66" OD	3/16"	Bare	0.04 lbs.	100
#81216	1" x 1.34"						0.06 lbs.	100
#81217	1" x 1.59"						0.07 lbs.	100
#81218	1" x 1.84"						0.08 lbs.	100
#81219	1" x 2.09"						0.10 lbs.	100
#81220	1" x 2.34"						0.11 lbs.	100
#81221	1" x 1.08"	0.40"	0.95"	1.90" OD	3/16"	Bare	0.04 lbs.	100
#81222	1" x 1.33"						0.06 lbs.	100
#81223	1" x 1.58"						0.07 lbs.	100
#81224	1" x 1.83"						0.08 lbs.	100
#81225	1" x 2.08"						0.10 lbs.	100
#81226	1" x 2.33"						0.11 lbs.	100
#81227	1.31" x 1.62"	0.53"	0.75"	1.50" OD	3/16"	Bare	0.08 lbs.	100
#81228	1.31" x 1.87"						0.10 lbs.	100
#81229	1.31" x 2.12"						0.12 lbs.	100
#81230	1.31" x 2.37"						0.13 lbs.	100
#81231	1.31" x 2.62"						0.15 lbs.	100



New

**Radius Surface Mount Tabs**

Item #	Size (Width x Height)	Hole Diameter	Radius	Fits Tube	Thickness	Finish	Wt. lbs.	Qty.
#81232	1.31" x 1.60"	0.53"	0.83"	1.66" OD	3/16"	Bare	0.08 lbs.	100
#81233	1.31" x 1.85"						0.10 lbs.	100
#81234	1.31" x 2.10"						0.12 lbs.	100
#81235	1.31" x 2.35"						0.13 lbs.	100
#81236	1.31" x 2.60"						0.15 lbs.	100
#81237	1.31" x 1.57"	0.53"	0.95"	1.90" OD	3/16"	Bare	0.08 lbs.	100
#81238	1.31" x 1.82"						0.10 lbs.	100
#81239	1.31" x 2.07"						0.12 lbs.	100
#81240	1.31" x 2.32"						0.13 lbs.	100
#81241	1.31" x 2.57"						0.15 lbs.	100
#81242	1.31" x 1.54"	0.53"	1.19"	2.375" OD	3/16"	Bare	0.08 lbs.	100
#81243	1.31" x 1.79"						0.10 lbs.	100
#81244	1.31" x 2.04"						0.12 lbs.	100
#81245	1.31" x 2.29"						0.13 lbs.	100
#81246	1.31" x 2.54"						0.15 lbs.	100
#81247	1.31" x 1.51"	0.53"	1.44"	2.875" OD	3/16"	Bare	0.08 lbs.	100
#81248	1.31" x 1.76"						0.10 lbs.	100
#81249	1.31" x 2.01"						0.11 lbs.	100
#81250	1.31" x 2.26"						0.13 lbs.	100
#81251	1.31" x 2.51"						0.15 lbs.	100
#81252	1.58" x 2.15"	0.63"	0.75"	1.50" OD	3/16"	Bare	0.13 lbs.	100
#81253	1.58" x 2.65"						0.17 lbs.	100
#81254	1.58" x 2.90"						0.19 lbs.	100
#81255	1.58" x 2.40"						0.15 lbs.	100
#81256	1.58" x 2.10"	0.63"	0.83"	1.66" OD	3/16"	Bare	0.13 lbs.	100
#81257	1.58" x 2.35"						0.15 lbs.	100
#81258	1.58" x 2.60"						0.17 lbs.	100
#81259	1.58" x 2.85"						0.19 lbs.	100
#81260	1.58" x 2.05"	0.63"	0.95"	1.90" OD	3/16"	Bare	0.13 lbs.	100
#81261	1.58" x 2.30"						0.15 lbs.	100
#81262	1.58" x 2.55"						0.17 lbs.	100
#81263	1.58" x 2.80"						0.19 lbs.	100
#81264	1.58" x 1.99"	0.63"	1.19"	2.375" OD	3/16"	Bare	0.13 lbs.	100
#81265	1.58" x 2.24"						0.15 lbs.	100
#81266	1.58" x 2.49"						0.17 lbs.	100
#81267	1.58" x 2.74"						0.19 lbs.	100
#81268	1.58" x 1.95"	0.63"	1.44"	2.875" OD	3/16"	Bare	0.13 lbs.	100
#81269	1.58" x 2.20"						0.15 lbs.	100
#81270	1.58" x 2.45"						0.17 lbs.	100
#81271	1.58" x 2.70"						0.19 lbs.	100



*New*

## Triangular Radius Surface Mount Tabs

Item #	Size (Width x Height)	Hole Diameter	Radius	Fits Tube	Thickness	Finish	Wt. lbs.	Qty.
#81272	1.50" x 1.43"	0.40"	0.63"	1.25" OD	3/16"	Bare	0.06 lbs.	100
#81273	1.50" x 1.68"						0.08 lbs.	100
#81274	1.50" x 1.93"						0.09 lbs.	100
#81275	1.50" x 2.18"						0.11 lbs.	100
#81276	1.50" x 2.43"						0.12 lbs.	100
#81277	1.50" x 2.368"						0.14 lbs.	100
#81278	1.50" x 2.93"						0.16 lbs.	100
<hr/>								
#81279	1.50" x 1.39"	0.40"	0.66"	1.315" OD	3/16"	Bare	0.06 lbs.	100
#81280	1.50" x 1.64"						0.08 lbs.	100
#81281	1.50" x 1.89"						0.09 lbs.	100
#81282	1.50" x 2.14"						0.11 lbs.	100
#81283	1.50" x 2.39"						0.12 lbs.	100
#81284	1.50" x 2.64"						0.14 lbs.	100
#81285	1.50" x 2.89"						0.16 lbs.	100
<hr/>								
#81286	1.50" x 1.31"	0.40"	0.75"	1.50" OD	3/16"	Bare	0.06 lbs.	100
#81287	1.50" x 1.56"						0.07 lbs.	100
#81288	1.50" x 1.81"						0.09 lbs.	100
#81289	1.50" x 2.06"						0.11 lbs.	100
#81290	1.50" x 2.31"						0.12 lbs.	100
#81291	1.50" x 2.56"						0.14 lbs.	100
#81292	1.50" x 2.81"						0.16 lbs.	100
<hr/>								
#81293	1.50" x 1.27"	0.40"	0.83"	1.66" OD	3/16"	Bare	0.06 lbs.	100
#81294	1.50" x 1.52"						0.07 lbs.	100
#81295	1.50" x 1.77"						0.09 lbs.	100
#81296	1.50" x 2.02"						0.11 lbs.	100
#81297	1.50" x 2.27"						0.12 lbs.	100
#81298	1.50" x 2.52"						0.14 lbs.	100
#81299	1.50" x 2.77"						0.15 lbs.	100
<hr/>								
#81300	1.50" x 1.23"	0.40"	0.95"	1.90" OD	3/16"	Bare	0.06 lbs.	100
#81301	1.50" x 1.48"						0.07 lbs.	100
#81302	1.50" x 1.73"						0.09 lbs.	100
#81303	1.50" x 1.98"						0.10 lbs.	100
#81304	1.50" x 2.23"						0.12 lbs.	100
#81305	1.50" x 2.48"						0.14 lbs.	100
#81306	1.50" x 2.73"						0.15 lbs.	100
<hr/>								
#81307	1.75" x 1.93"	0.53"	0.75"	1.50" OD	3/16"	Bare	0.10 lbs.	100
#81308	1.75" x 2.18"						0.12 lbs.	100
#81309	1.75" x 2.43"						0.14 lbs.	100
#81310	1.75" x 2.68"						0.16 lbs.	100
#81311	1.75" x 2.93"						0.18 lbs.	100
#81312	1.75" x 3.18"						0.20 lbs.	100
<hr/>								
#81313	1.75" x 1.84"	0.53"	0.83"	1.66" OD	3/16"	Bare	0.10 lbs.	100
#81314	1.75" x 2.09"						0.12 lbs.	100
#81315	1.75" x 2.34"						0.14 lbs.	100

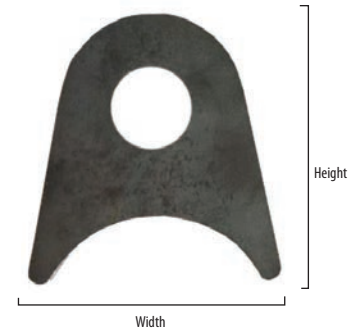



New

**Triangular Radius Surface Mount Tabs**

Item #	Size (Width x Height)	Hole Diameter	Radius	Fits Tube	Thickness	Finish	Wt. lbs.	Qty.
#81316	1.75" x 2.59"	0.53"	0.83"	1.66" OD	3/16"	Bare	0.16 lbs.	100
#81317	1.75" x 2.84"						0.18 lbs.	100
#81318	1.75" x 3.09"						0.20 lbs.	100
#81319	1.75" x 1.76"	0.53"	0.95"	1.90" OD	3/16"	Bare	0.10 lbs.	100
#81320	1.75" x 2.01"						0.12 lbs.	100
#81321	1.75" x 2.26"						0.14 lbs.	100
#81322	1.75" x 2.51"						0.16 lbs.	100
#81323	1.75" x 2.76"						0.18 lbs.	100
#81324	1.75" x 3.01"						0.20 lbs.	100
#81325	1.75" x 1.67"	0.53"	1.19"	2.375" OD	3/16"	Bare	0.10 lbs.	100
#81326	1.75" x 1.92"						0.12 lbs.	100
#81327	1.75" x 2.17"						0.14 lbs.	100
#81328	1.75" x 2.42"						0.16 lbs.	100
#81329	1.75" x 2.67"						0.18 lbs.	100
#81330	1.75" x 2.92"						0.20 lbs.	100
#81331	1.75" x 1.62"	0.53"	1.44"	2.875" OD	3/16"	Bare	0.10 lbs.	100
#81332	1.75" x 1.87"						0.11 lbs.	100
#81333	1.75" x 2.12"						0.13 lbs.	100
#81334	1.75" x 2.37"						0.15 lbs.	100
#81335	1.75" x 2.62"						0.17 lbs.	100
#81336	1.75" x 2.87"						0.20 lbs.	100
#81337	2.00" x 2.28"	0.63"	0.83"	1.66" OD	3/16"	Bare	0.13 lbs.	100
#81338	2.00" x 2.53"						0.15 lbs.	100
#81339	2.00" x 2.78"						0.18 lbs.	100
#81340	2.00" x 3.03"						0.20 lbs.	100
#81341	2.00" x 3.28"						0.22 lbs.	100
#81342	2.00" x 3.53"						0.25 lbs.	100
#81343	2.00" x 2.06"	0.63"	0.95"	1.90" OD	3/16"	Bare	0.12 lbs.	100
#81344	2.00" x 2.31"						0.15 lbs.	100
#81345	2.00" x 2.56"						0.17 lbs.	100
#81346	2.00" x 2.81"						0.20 lbs.	100
#81347	2.00" x 3.06"						0.22 lbs.	100
#81348	2.00" x 3.31"						0.24 lbs.	100
#81349	2.00" x 1.91"	0.63"	1.19"	2.375" OD	3/16"	Bare	0.12 lbs.	100
#81350	2.00" x 2.16"						0.14 lbs.	100
#81351	2.00" x 2.41"						0.17 lbs.	100
#81352	2.00" x 2.66"						0.20 lbs.	100
#81353	2.00" x 2.91"						0.22 lbs.	100
#81354	2.00" x 3.16"						0.24 lbs.	100
#81355	2.00" x 1.83"	0.63"	1.44"	2.875" OD	3/16"	Bare	0.12 lbs.	100
#81356	2.00" x 2.08"						0.14 lbs.	100
#81357	2.00" x 2.33"						0.17 lbs.	100
#81358	2.00" x 2.58"						0.20 lbs.	100
#81359	2.00" x 2.83"						0.21 lbs.	100
#81433	2.50" x 2.25"						0.99"	1.44"

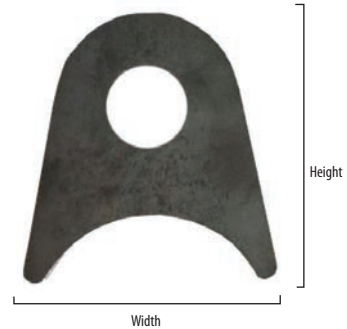

# WELDING WELDING TABS

*New*

## Flat Surface Mount Tabs

Item #	Size (Width x Height)	Hole Diameter	Thickness	Finish	Wt. lbs.	Qty.
#81153	1" x 1"	0.40"	3/16"	Bare	0.04 lbs.	100
#81154	1" x 1.25"				0.05 lbs.	100
#81155	1" x 1.50"				0.06 lbs.	100
#81156	1" x 1.75"				0.08 lbs.	100
#81157	1" x 2"				0.09 lbs.	100
#81158	1" x 2.25"				0.11 lbs.	100
#81159	1" x 2.50"				0.12 lbs.	100
#81160	1.31" x 1.38"	0.53"	3/16"	Bare	0.07 lbs.	100
#81161	1.31" x 1.63"				0.09 lbs.	100
#81162	1.31" x 1.88"				0.11 lbs.	100
#81163	1.31" x 2.13"				0.12 lbs.	100
#81164	1.31" x 2.38"				0.14 lbs.	100
#81165	1.31" x 2.63"				0.16 lbs.	100
#81166	1.31" x 2.88"				0.18 lbs.	100
#81167	1.63" x 1.75"	0.65"	3/16"	Bare	0.12 lbs.	100
#81168	1.63" x 2"				0.14 lbs.	100
#81169	1.63" x 2.25"				0.16 lbs.	100
#81170	1.63" x 2.50"				0.18 lbs.	100
#81171	1.63" x 2.75"				0.20 lbs.	100
#81172	1.63" x 3"				0.22 lbs.	100
#81432	2.50" x 2.33"				0.929"	1/4"

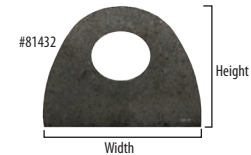

*New*

## Triangular Flat Surface Mount Tabs

Item #	Size (Width x Height)	Hole Diameter	Thickness	Finish	Wt. lbs.	Qty.
#81173	1.50" x 1"	0.40"	3/16"	Bare	0.05 lbs.	100
#81174	1.50" x 1.25"				0.06 lbs.	100
#81175	1.50" x 1.50"				0.08 lbs.	100
#81176	1.50" x 1.75"				0.10 lbs.	100
#81177	1.50" x 2"				0.12 lbs.	100
#81178	1.50" x 2.25"				0.13 lbs.	100
#81179	1.50" x 2.50"				0.15 lbs.	100
#81180	2" x 1.41"	0.53"	3/16"	Bare	0.10 lbs.	100
#81181	2" x 1.66"				0.12 lbs.	100
#81182	2" x 1.91"				0.14 lbs.	100
#81183	2" x 2.16"				0.16 lbs.	100
#81184	2" x 2.41"				0.18 lbs.	100
#81185	2" x 2.66"				0.21 lbs.	100
#81186	2.50" x 1.79"				0.63"	3/16"
#81187	2.50" x 2.04"	0.18 lbs.	100			
#81188	2.50" x 2.29"	0.21 lbs.	100			
#81189	2.50" x 2.54"	0.23 lbs.	100			
#81190	2.50" x 2.79"	0.26 lbs.	100			

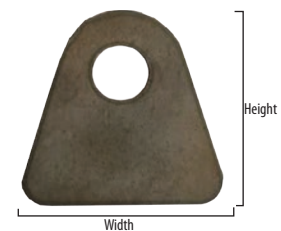

## Spring Creek™ Products

Check out some of our customers' projects!  
Share your projects with us at [sales@springcreekproducts.com](mailto:sales@springcreekproducts.com)!



Installing pipe fence is easy with our saddle cut pipe guides and cable clips!



Keep those pesky critters out of your garden! We have the hinges, latches, and post caps you need!



Our variety of hinges, latches, and post caps are perfect for building gates or fences for your property!



Get creative with our tank heads, expanded metal, and cut to length section to build your backyard fire pit!



# WELDING CUT-TO-LENGTH PRODUCTS

## Threaded Rod - Grade A

Item #	Size	Length	Finish	Wt. lbs.	Qty.
#80829	1/4"	3'	Zinc	0.37 lbs.	1
#80825	3/8"	3'	Zinc	0.88 lbs.	1
#80828	1/2"	3'	Zinc	1.60 lbs.	1
#80824	5/8"	3'	Zinc	2.53 lbs.	1
#80827	3/4"	3'	Zinc	3.72 lbs.	1
#80826	7/8"	3'	Zinc	5.13 lbs.	1
#80830	1"	3'	Zinc	6.72 lbs.	1

Item #	Size	Length	Finish	Wt. lbs.	Qty.
#50598	1/4"	6'	Zinc	0.73 lbs.	1
#50601	3/8"	6'	Zinc	1.76 lbs.	1
#50604	1/2"	6'	Zinc	3.20 lbs.	1
#50607	5/8"	6'	Zinc	5.06 lbs.	1
#80147	3/4"	6'	Zinc	7.44 lbs.	1
#80148	7/8"	6'	Zinc	10.26 lbs.	1
#80149	1"	6'	Zinc	13.44 lbs.	1

Item #	Size	Length	Finish	Wt. lbs.	Qty.
#50597	1/4"	4'	Zinc	0.49 lbs.	1
#50600	3/8"	4'	Zinc	1.17 lbs.	1
#50603	1/2"	4'	Zinc	2.13 lbs.	1
#50606	5/8"	4'	Zinc	3.37 lbs.	1
#80144	3/4"	4'	Zinc	4.96 lbs.	1
#80145	7/8"	4'	Zinc	6.84 lbs.	1
#80146	1"	4'	Zinc	8.96 lbs.	1

Item #	Size	Length	Finish	Wt. lbs.	Qty.
#50599	1/4"	10'	Zinc	1.22 lbs.	1
#50602	3/8"	10'	Zinc	2.93 lbs.	1
#50605	1/2"	10'	Zinc	5.33 lbs.	1
#50608	5/8"	10'	Zinc	8.43 lbs.	1
#50671	3/4"	10'	Zinc	12.35 lbs.	1
#50672	7/8"	10'	Zinc	17.05 lbs.	1
#50673	1"	10'	Zinc	22.31 lbs.	1

Free Freight Does Not Apply to 10' Pieces



## Round Bar - Cold Rolled

Item #	Size	Length	Finish	Wt. lbs.	Qty.
#48304	3/8"	2'	Bare	0.75 lbs.	1
#48306	3/8"	4'	Bare	1.50 lbs.	1
#48307	1/2"	2'	Bare	1.31 lbs.	1
#48309	1/2"	4'	Bare	2.62 lbs.	1
#48310	3/4"	2'	Bare	3.00 lbs.	1
#48312	3/4"	4'	Bare	6.00 lbs.	1
#80800	7/8"	2'	Bare	4.00 lbs.	1

## Round Bar - Hot Rolled

Item #	Size	Length	Finish	Wt. lbs.	Qty.
#48313	3/8"	2'	Bare	0.75 lbs.	1
#48315	3/8"	4'	Bare	1.50 lbs.	1
#48316	1/2"	2'	Bare	1.34 lbs.	1
#48318	1/2"	4'	Bare	2.68 lbs.	1
#48319	3/4"	2'	Bare	3.00 lbs.	1
#48321	3/4"	4'	Bare	6.00 lbs.	1

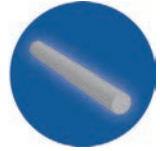

## Round Tubing- 14ga

Item #	Size	Length	Finish	Wt. lbs.	Qty.
#48352	1.25" O.D.	2'	Bare	1.81 lbs.	1
#48354	1.25" O.D.	4'	Bare	3.62 lbs.	1
#48355	1.50" O.D.	2'	Bare	2.20 lbs.	1
#48357	1.50" O.D.	4'	Bare	4.39 lbs.	1

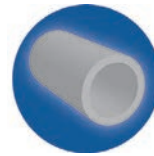

## Expanded Metal

Item #	Size	Length	Finish	Wt. lbs.	Qty.
#47904	3/4" x #9	12" x 24"	Bare	3.30 lbs.	2
#47905	1/2" x #13	12" x 24"	Bare	3.30 lbs.	2



## Rebar - Grade 60

Item #	Size	Length	Finish	Wt. lbs.	Qty.
#48358	1/2"	2'	Bare	1.34 lbs.	10
#48360	1/2"	4'	Bare	2.67 lbs.	10

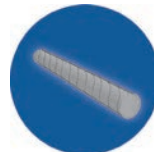



**Square Tubing - 16ga**

Item #	Size	Length	Finish	Wt. lbs.	Qty.
#48322	0.50" x 0.50"	2'	Bare	0.73 lbs.	1
#48324	0.50" x 0.50"	4'	Bare	1.46 lbs.	1
#48325	0.75" x 0.75"	2'	Bare	1.15 lbs.	1
#48327	0.75" x 0.75"	4'	Bare	2.31 lbs.	1
#48328	1.00" x 1.00"	2'	Bare	1.58 lbs.	1
#48330	1.00" x 1.00"	4'	Bare	3.16 lbs.	1
#48331	1.25" x 1.25"	2'	Bare	2.07 lbs.	1
#48333	1.25" x 1.25"	4'	Bare	4.14 lbs.	1
#48334	1.50" x 1.50"	2'	Bare	2.44 lbs.	1
#48336	1.50" x 1.50"	4'	Bare	4.88 lbs.	1

**Square Tubing - 11ga**

Item #	Size	Length	Finish	Wt. lbs.	Qty.
#48337	1.00" x 1.00"	2'	Bare	2.80 lbs.	1
#48339	1.00" x 1.00"	4'	Bare	5.60 lbs.	1
#48340	1.25" x 1.25"	2'	Bare	3.58 lbs.	1
#48342	1.25" x 1.25"	4'	Bare	7.16 lbs.	1
#48343	1.50" x 1.50"	2'	Bare	4.36 lbs.	1
#48345	1.50" x 1.50"	4'	Bare	8.72 lbs.	1

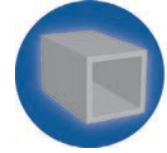

**Square Bar - Cold Rolled**

Item #	Size	Length	Finish	Wt. lbs.	Qty.
#48295	3/8"	2'	Bare	0.96 lbs.	1
#48297	3/8"	4'	Bare	1.91 lbs.	1
#48298	1/2"	2'	Bare	1.66 lbs.	1
#48300	1/2"	4'	Bare	3.40 lbs.	1
#48301	3/4"	2'	Bare	3.77 lbs.	1
#48303	3/4"	4'	Bare	7.65 lbs.	1

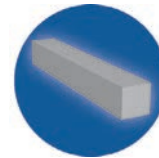

**Rectangular Tubing - 14ga**

Item #	Size	Length	Finish	Wt. lbs.	Qty.
#48346	2" x 1"	2'	Bare	2.83 lbs.	1
#48348	2" x 1"	4'	Bare	5.67 lbs.	1

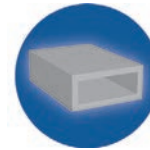

**Flat Bar - 1/8"**

Item #	Size	Length	Finish	Wt. lbs.	Qty.
#48271	1.00"	2'	Bare	0.85 lbs.	1
#48273	1.00"	4'	Bare	1.70 lbs.	1
#48274	1.50"	2'	Bare	1.28 lbs.	1
#48276	1.50"	4'	Bare	2.55 lbs.	1
#48277	2.00"	2'	Bare	1.70 lbs.	1
#48279	2.00"	4'	Bare	3.40 lbs.	1
#48280	3.00"	2'	Bare	2.55 lbs.	1
#48282	3.00"	4'	Bare	5.10 lbs.	1

**Flat Bar - 1/4"**

Item #	Size	Length	Finish	Wt. lbs.	Qty.
#48283	1.00"	2'	Bare	1.70 lbs.	1
#48285	1.00"	4'	Bare	3.40 lbs.	1
#48286	1.50"	2'	Bare	2.55 lbs.	1
#48288	1.50"	4'	Bare	5.10 lbs.	1
#48289	2.00"	2'	Bare	3.40 lbs.	1
#48291	2.00"	4'	Bare	6.80 lbs.	1
#48292	3.00"	2'	Bare	5.10 lbs.	1
#48294	3.00"	4'	Bare	10.20 lbs.	1

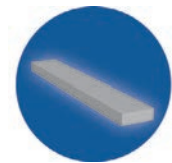

**Visit us at**  
[www.springcreekproducts.com](http://www.springcreekproducts.com)

**Angle Iron - 1/8"**

Item #	Size	Length	Finish	Wt. lbs.	Qty.
#48247	1.00" x 1.00"	2'	Bare	1.60 lbs.	1
#48249	1.00" x 1.00"	4'	Bare	3.20 lbs.	1
#48250	1.25" x 1.25"	2'	Bare	2.02 lbs.	1
#48252	1.25" x 1.25"	4'	Bare	4.04 lbs.	1
#48253	1.50" x 1.50"	2'	Bare	2.46 lbs.	1
#48255	1.50" x 1.50"	4'	Bare	4.92 lbs.	1

**Angle Iron - 3/16"**

Item #	Size	Length	Finish	Wt. lbs.	Qty.
#48259	1.00" x 1.00"	2'	Bare	2.32 lbs.	1
#48261	1.00" x 1.00"	4'	Bare	4.64 lbs.	1
#48262	1.25" x 1.25"	2'	Bare	2.96 lbs.	1
#48264	1.25" x 1.25"	4'	Bare	5.92 lbs.	1
#48265	1.50" x 1.50"	2'	Bare	3.60 lbs.	1
#48267	1.50" x 1.50"	4'	Bare	7.20 lbs.	1

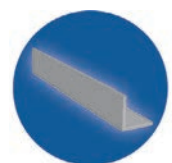

**T27 Zirconia Flap Discs**

Ferrous metals, steel, structural steel, rebar, pipe, bar stock

Item #	Diameter x Width x Arbor	Density	Grit	Max RPM	Wt. lbs.	Qty.
#70155	4-1/2" x 7/8"	Standard	24	13,300	0.15 lbs.	10
#70156	4-1/2" x 7/8"	Standard	40	13,300	0.15 lbs.	10
#70157	4-1/2" x 7/8"	Standard	60	13,300	0.15 lbs.	10
#70158	4-1/2" x 7/8"	Standard	80	13,300	0.15 lbs.	10
#70159	4-1/2" x 7/8"	Standard	120	13,300	0.15 lbs.	10



**T29 Zirconia Flap Discs**

Ferrous, non ferrous metals, grinding, blending, finishing

Item #	Diameter x Width	Density	Grit	Max RPM	Wt. lbs.	Qty.
#70139	4-1/2" x 7/8"	High	40	13,300	0.30 lbs.	10
#70140	4-1/2" x 7/8"	Standard	24	13,300	0.30 lbs.	10
#70141	4-1/2" x 7/8"	Standard	36	13,300	0.30 lbs.	10
#70142	4-1/2" x 7/8"	Standard	40	13,300	0.30 lbs.	10
#70143	4-1/2" x 7/8"	Standard	60	13,300	0.30 lbs.	10
#70144	4-1/2" x 7/8"	Standard	80	13,300	0.30 lbs.	10
#70145	4-1/2" x 7/8"	Standard	120	13,300	0.30 lbs.	10
#70146	4-1/2" x 5/8"-11	High	24	13,300	0.55 lbs.	10 *
#70147	4-1/2" x 5/8"-11	High	36	13,300	0.55 lbs.	10 *
#70148	4-1/2" x 5/8"-11	High	40	13,300	0.55 lbs.	10 *
#70149	4-1/2" x 5/8"-11	High	60	13,300	0.55 lbs.	10 *
#70150	4-1/2" x 5/8"-11	High	80	13,300	0.55 lbs.	10 *
#70151	4-1/2" x 5/8"-11	High	120	13,300	0.55 lbs.	10 *
#70152	4-1/2" x 5/8"-11	Standard	120	13,300	0.55 lbs.	10 *
#70153	5" x 5/8"-11	High	40	12,200	0.55 lbs.	10 *
#70154	5" x 5/8"-11	High	60	12,200	0.55 lbs.	10 *



\*With Hub

**Trimmable Type 27 Zirconia Flap Discs**

Item #	Diameter x Width x Arbor	Density	Grit	Max RPM	Wt. lbs.	Qty.
#70124	4-1/2" x 5/8"-11	High	36	13,300	0.30 lbs.	10
#70125	4-1/2" x 5/8"-11	High	40	13,300	0.30 lbs.	10
#70126	4-1/2" x 5/8"-11	High	60	13,300	0.30 lbs.	10
#70127	4-1/2" x 5/8"-11	High	80	13,300	0.30 lbs.	10
#70128	4-1/2" x 5/8"-11	High	120	13,300	0.30 lbs.	10



**Trimmable Type 29 Zirconia Flap Discs**

Item #	Diameter x Width x Arbor	Density	Grit	Max RPM	Wt. lbs.	Qty.
#70129	4-1/2" x 5/8"-11	High	36	13,300	0.35 lbs.	10
#70130	4-1/2" x 5/8"-11	High	40	13,300	0.35 lbs.	10
#70131	4-1/2" x 5/8"-11	High	60	13,300	0.30 lbs.	10
#70132	4-1/2" x 5/8"-11	High	80	13,300	0.30 lbs.	10
#70133	4-1/2" x 5/8"-11	High	120	13,300	0.30 lbs.	10
#70134	4-1/2" x 5/8"-11	Standard	36	13,300	0.25 lbs.	10
#70135	4-1/2" x 5/8"-11	Standard	40	13,300	0.25 lbs.	10
#70136	4-1/2" x 5/8"-11	Standard	60	13,300	0.25 lbs.	10
#70137	4-1/2" x 5/8"-11	Standard	80	13,300	0.25 lbs.	10
#70138	4-1/2" x 5/8"-11	Standard	120	13,300	0.25 lbs.	10



**Type 27 Depressed Center Grinding Wheels - Single Grit**

Ferrous metals, structural steel, rebar, pipe, bar stock, welds

Item #	Diameter x Width x Arbor	Max RPM	Wt. lbs.	Qty.
#70104	4-1/2" x 1/4" x 7/8"	13,300	0.35 lbs.	25
#70105	4-1/2" x 1/4" x 5/8"-11	13,300	0.55 lbs.	20 *
#70106	5" x 1/4" x 7/8"	12,200	0.40 lbs.	25
#70107	5" x 1/4" x 5/8"-11	12,200	0.65 lbs.	20 *
#70108	7" x 1/4" x 7/8"	8,500	0.85 lbs.	20
#70109	7" x 1/4" x 5/8"-11	8,500	1.20 lbs.	10 *

\*With Hub



**Type 27 Depressed Center Grinding Wheels - Dual Grit**

Ferrous metals, structural steel, rebar, pipe, bar stock, welds

Item #	Diameter x Width x Arbor	Max RPM	Wt. lbs.	Qty.
#70092	4-1/2" x 1/4" x 7/8"	13,300	0.34 lbs.	25
#70093	4-1/2" x 1/4" x 5/8"-11	13,300	0.55 lbs.	20 *
#70094	6" x 1/4" x 5/8"-11	10,200	0.70 lbs.	10 *
#70095	7" x 1/4" x 7/8"	8,500	0.84 lbs.	20
#70096	7" x 1/4" x 5/8"-11	8,500	1.10 lbs.	10 *

\*With Hub

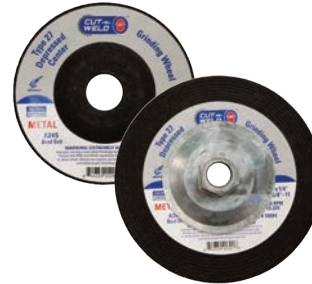

**T27 Depressed Center Pipe Cutting And Grinding Wheels - Single Grit**

Ferrous metals, structural steel, rebar, pipe, bar stock, welds

Item #	Diameter x Width x Arbor	Max RPM	Wt. lbs.	Qty.
#70097	4-1/2" x 1/8" x 7/8"	13,300	0.19 lbs.	25
#70098	4-1/2" x 1/8" x 5/8"-11	13,300	0.40 lbs.	20 *
#70099	5" x 1/8" x 7/8"	12,200	0.32 lbs.	25
#70100	5" x 1/8" x 5/8"-11	12,200	0.60 lbs.	20 *

\*With Hub



**Carbo White™ Grind Wheel**

Item #	Diameter x Width x Arbor	Type	Wt. lbs.	Qty.
#47779	4-1/2" x 1/4" x 7/8"	No Hub	0.94 lbs.	20



**Type 1 Low Horsepower Chop Saw Wheels**

Double Reinforce: cut thin wall tube, light-gauge ferrous metals, thin merchant bars  
Center Reinforce: ferrous metals, structural steel, small merchant bars, steel tubing

Item #	Reinforce Type	Diameter x Width x Arbor	Max RPM	Wt. lbs.	Qty.
#70090	Double	14" x 3/32" x 1"	4,400	1.40 lbs.	10
#70091	Center	14" x 7/64" x 1"	4,400	1.50 lbs.	10



**Type 1 Portable Circular Saw Wheels**

Ferrous metals, rebar, bar stock

Item #	Reinforce Type	Diameter x Width x Arbor	Max RPM	Wt. lbs.	Qty.
#70113	Double	7" x 1/8" x 5/8"	8,700	0.04 lbs.	25



**Stationary Saw Cut-Off Wheels, Double Reinforced**

Ferrous metals, steel, structural steel, rebar, bar stock

Item #	Diameter x Width x Arbor	Max RPM	Wt. lbs.	Qty.
#70120	16" x 1/8" x 1"	3,800	1.40 lbs.	10
#70121	16" x 5/32" x 1"	3,800	2.72 lbs.	10
#70122	18" x 5/32" x 1"	3,400	3.16 lbs.	5
#70123	20" x 5/32" x 1"	3,000	4.40 lbs.	5



**Mercer® Ceraflame 2**

Item #	Diameter x Arbor	Grit	Wt. lbs.	Qty.
#80039	4-1/2" x 7/8"	60	0.01 lbs.	20



**Stringer Bead Wire Wheel**

Item #	Diameter x Width x Arbor	Max RPM	Wt. lbs.	Qty.
#70205	4" x 3/16" x 5/8"-11	20,000	0.50 lbs.	6



*New*

**Stringer Bead Wire Wheel**

Item #	Diameter x Width x Arbor	Max RPM	Finish	Wt. lbs.	Qty.
#81459	4" x 5/16" x 5/8"-11	20,000	Stainless	0.40 lbs.	12
#81608	4" x 5/16" x 5/8" - 11	20,000	Bare	0.40 lbs.	12
#81460	6" x 5/16" x 5/8" - 11	12,000	Bare	0.88 lbs.	10
#81461	6" x 5/16" x 5/8" - 11	12,000	Stainless	0.88 lbs.	10
#81462	7" x 5/16" x 5/8" - 11	9,000	Bare	1.33 lbs.	10
#81463	7" x 5/16" x 5/8" - 11	9,000	Stainless	1.66 lbs.	10



#81459



#81462

**Knot Wire Wheel - Standard Twist**

Item #	Diameter x Width x Arbor	Max RPM	Wt. lbs.	Qty.
#70202	4" x 1/2" x 5/8"-11	20,000	0.67 lbs.	6



**Knot Cup Brush**

Item #	Type	Diameter x Width x Arbor	Max RPM	Wt. lbs.	Qty.
#70204	Knot	2-3/4" x 5/8"-11	14,000	0.66 lbs.	6
#70206	Crimped	2-3/4" x 5/8"-11	12,500	1.50 lbs.	12



#70204



#70206

**Crimped Wire Wheel**

Item #	Diameter x Width x Arbor	Max RPM	Wt. lbs.	Qty.
#70203	4" x 1/2" x 5/8"-11	12,500	0.50 lbs.	6





**Type 1 Cut-Off Wheels**

Alloy, rebar, metal tubing, light-gauge metals

Item #	Reinforce Type	Diameter x Width x Arbor	Max RPM	Wt. lbs.	Qty.
#70101	Double	4.5" x .045" x 7/8"	13,300	0.07 lbs.	50
#70102	Double	5" x .045" x 7/8"	12,200	0.12 lbs.	25
#70103	Double	6" x 1/16" x 7/8"	10,200	0.16 lbs.	25



**Type 27 Depressed Center Cut-Off Wheels**

Alloy, rebar, metal tubing, light-gauge metals

Item #	Reinforce Type	Diameter x Width x Arbor	Max RPM	Wt. lbs.	Qty.
#70111	Double	4.5" x .045" x 5/8"-11	13,300	0.12 lbs.	20 *
#70112	Double	4.5" x .045" x 7/8"	13,300	0.07 lbs.	50
#70110	Double	6" x .045" x 7/8"	10,200	0.15 lbs.	25



\*With Hub

**Mercer® ZSpeed T1 Cut-Off Wheels**

Item #	Diameter x Width x Arbor	Max RPM	Wt. lbs.	Qty.
#80017	4-1/2" x .045 x 7/8"	13,300	1.00 lbs.	50
#80018	5" x .045 x 7/8"	12,200	1.00 lbs.	25
#80019	6" x .045 x 7/8"	10,200	1.00 lbs.	25



**Mercer® ZSpeed T27 Cut-Off Wheels**

Item #	Diameter x Width x Arbor	Max RPM	Wt. lbs.	Qty.
#80020	4-1/2" x .045 x 7/8"	13,300	1.00 lbs.	50
#80021	4-1/2" x .045 x 5/8"-11	13,300	1.00 lbs.	20
#80022	5" x .045 x 7/8"	12,200	1.00 lbs.	25
#80023	5" x .045" x 5/8"-11	12,200	1.00 lbs.	20
#80024	6" x .045 x 7/8"	8,500	1.00 lbs.	25
#80025	6" x .045 x 5/8"-11	8,500	1.00 lbs.	10



**Type 1 High Speed Cut-Off Wheels**

Ferrous metals, structural steel, thin rebar, thin iron pipe, bar stock, light-gauge steel

Item #	Reinforce Type	Diameter x Width x Arbor	Grit	Max RPM	Wt. lbs.	Qty.
#70114	Double	3" x 1/16" x 3/8"	M	25,000	0.05 lbs.	100
#70115	Double	3" x 1/16" x 3/8"	C	25,000	0.05 lbs.	100
#70116	Double	4-1/2" x 1/16" x 7/8"	C	13,300	1.00 lbs.	50



**Type 1 High Speed Cut-Off Wheels For Portable Gas Saws**

Ferrous metals, structural steel, rebar, bar stock, steel decking

Item #	Reinforce Type	Diameter x Width x Arbor	Max RPM	Wt. lbs.	Qty.
#70117	Double	12" x 1/8"(5/32) x 20mm	6,300	1.53 lbs.	10
#70118	Double	14" x 1/8"(5/32) x 1"	5,400	2.10 lbs.	10
#70119	Double	14" x 1/8"(5/32) x 20mm	5,460	2.10 lbs.	10



TOOLS  
SAWS / BLADES

**Metal Devil® 7" Metal-Cutting Circular Saw**

11 amps, 1080 watts, 3500 RPM

Item #	Wt. lbs.	Qty.
#47948	16.00 lbs.	1

Free Freight Does Not Apply



**Metal Devil®**

**Metal Devil® 9" Metal-Cutting Circular Saw**

15 amps, 1800 watts, 2500 RPM

Item #	Wt. lbs.	Qty.
#47949	24.00 lbs.	1

Free Freight Does Not Apply



**Metal Devil®**

**Metal Devil® 14" Metal-Cutting Circular Saw**

15 amps, 1800 watts, 1300 RPM

Item #	Wt. lbs.	Qty.
#47950	55.00 lbs.	1

Free Freight Does Not Apply



**Metal Devil®**

**Metal Devil® Cutting Blades**

Item #	Size	Tooth	Arbor	Type	Fits	Wt. lbs.	Qty.
#47951	7"	40	20 mm	Steel	#47948	1.00 lbs.	1
#48029	7-1/4"	48	5/8" KO	Steel	#47948	1.00 lbs.	1



**Metal Devil®**

**Metal Devil® Cutting Blade**

Item #	Size	Tooth	Arbor	Wt. lbs.	Qty.
#48362	8"	48	5/8"	1.10 lbs.	1



**Metal Devil®**

**Metal Devil® Cutting Blade**

Item #	Size	Tooth	Arbor	Type	Fits	Wt. lbs.	Qty.
#47952	9"	48	1"	Steel	#47949	2.50 lbs.	1



**Metal Devil®**

**Metal Devil® Cutting Blade**

Item #	Size	Tooth	Arbor	Type	Fits	Wt. lbs.	Qty.
#47953	14"	66	1"	Steel	#47950	4.50 lbs.	1



**Metal Devil®**

**RZR Cermet Steel Blades**

Item #	Size	Teeth	Max RPM	Wt. lbs.	Qty.
#80899	5-3/8" x 20mm	26	6,000	0.35 lbs.	1
#80900	6-1/2" x 5/8"	32	6,000	0.55 lbs.	1
#80901	7" x 20mm	36	5,800	0.70 lbs.	1
#80790	7-1/4" x 5/8"	36	5,800	0.79 lbs.	1
#80902	7-1/4" x 20mm	36	5,800	0.75 lbs.	1
#80903	8" x 5/8"	40	4,500	1.05 lbs.	1
#80904	9" x 1"	44	3,500	1.50 lbs.	1
#80905	12" x 1"	54	1,700	2.70 lbs.	1
#80787	14" x 1"	64	1,500	3.29 lbs.	1



**Mercer® Steel Thunder Carbide Blades**

Item #	Size	Teeth	Max RPM	Wt. lbs.	Qty.
#80283	7-1/4" x 5/8"	36	5,800	0.86 lbs.	5
#80284	8" x 5/8"	48	5,800	1.06 lbs.	5
#80285	9" x 1"	48	5,800	1.42 lbs.	5
#80286	14" x 1"	72	1,800	2.01 lbs.	5



## Welding Displays

**Our welding display is a perfect addition  
for your showroom!  
Available in 4 foot, 8 foot, or 12 foot sections.**

**This display comes with welding accessories,  
tools and safety gear. Everything your customer needs!**



Contact a sales representative today for more details.

# TOOLS DRILL BITS

## Mechanics Length Drill Bits - Brute XL28

Single / Clamshell				Bulk			
Item #	Size	Wt. lbs.	Qty.	Item #	Size	Wt. lbs.	Qty.
#80938	1/16	0.06 lbs.	1	#80909	1/16	0.04 lbs.	12
#80939	5/64	0.06 lbs.	1	#80910	5/64	0.06 lbs.	12
#80940	3/32	0.06 lbs.	1	#80911	3/32	0.07 lbs.	12
#80941	7/64	0.07 lbs.	1	#80912	7/64	0.09 lbs.	12
#80942	1/8	0.07 lbs.	1	#80913	1/8	0.10 lbs.	12
#80943	9/64	0.08 lbs.	1	#80914	9/64	0.13 lbs.	12
#80944	5/32	0.08 lbs.	1	#80915	5/32	0.17 lbs.	12
#80945	11/64	0.07 lbs.	1	#80916	11/64	0.21 lbs.	12
#80946	3/16	0.07 lbs.	1	#80917	3/16	0.25 lbs.	12
#80947	13/64	0.07 lbs.	1	#80918	13/64	0.29 lbs.	12
#80948	7/32	0.09 lbs.	1	#80919	7/32	0.30 lbs.	12
#80949	15/64	0.09 lbs.	1	#80920	15/64	0.35 lbs.	12
#80950	1/4	0.09 lbs.	1	#80921	1/4	0.40 lbs.	12
#80951	17/64	0.10 lbs.	1	#80922	17/64	0.50 lbs.	12
#80952	9/32	0.10 lbs.	2	#80923	9/32	0.60 lbs.	12
#80953	19/64	0.11 lbs.	1	#80924	19/64	0.40 lbs.	6
#80954	5/16	0.12 lbs.	1	#80925	5/16	0.35 lbs.	6
#80955	21/64	0.13 lbs.	1	#80926	21/64	0.48 lbs.	6
#80956	11/32	0.13 lbs.	1	#80927	11/32	0.54 lbs.	6
#80957	23/64	0.14 lbs.	1	#80928	23/64	0.50 lbs.	6
#80958	3/8	0.12 lbs.	1	#80929	3/8	0.64 lbs.	6
#80959	25/64	0.16 lbs.	1	#80930	25/64	0.12 lbs.	6
#80960	13/32	0.18 lbs.	1	#80931	13/32	0.78 lbs.	6
#80961	27/64	0.18 lbs.	1	#80932	27/64	0.80 lbs.	6
#80962	7/16	0.19 lbs.	1	#80933	7/16	0.85 lbs.	6
#80963	29/64	0.20 lbs.	1	#80934	29/64	0.85 lbs.	6
#80964	15/32	0.26 lbs.	1	#80935	15/32	1.05 lbs.	6
#80965	31/64	0.23 lbs.	1	#80936	31/64	1.10 lbs.	6
#80966	1/2	0.24 lbs.	1	#80937	1/2	1.18 lbs.	6



## Twister-XL28 Bits

Item #	Wt. lbs.	Qty.
#80848	2.31 lbs.	1



## Silver & Deming Drill Bit - Brute XL12

Item #	Size	Wt. lbs.	Qty.
<i>New</i> #81620	3/4"	0.44 lbs.	1





**Combination Drill And Tap Bits**

Item #	Size	Wt. lbs.	Qty.
#80832	6 - 32	0.06 lbs.	1
#80833	8 - 32	0.07 lbs.	1
#80834	10 - 24	0.07 lbs.	1
#80835	10 - 32	0.07 lbs.	1
#80836	12 - 24	0.07 lbs.	1
#80837	1/4 - 20	0.07 lbs.	1
#80838	1/4 - 28	0.07 lbs.	1
#80839	5/16 - 18	0.08 lbs.	1
#80840	5/16 - 24	0.08 lbs.	1
#80841	3/8 - 16	0.11 lbs.	1
#80842	3/8 - 24	0.12 lbs.	1
#80843	7/16 - 14	0.13 lbs.	1
#80844	7/16 - 20	0.13 lbs.	1
#80845	1/2 - 13	0.14 lbs.	1
#80846	1/2 - 20	0.14 lbs.	1



**Rotary Hammer Bits - SDS Plus**

Item #	Size	Wt. lbs.	Qty.
#80873	3/16" x 4" x 6"	0.10 lbs.	1
#80874	1/4" x 2" x 4"	0.10 lbs.	1
#80875	1/4" x 4" x 6"	0.11 lbs.	1
#80876	1/4" x 6" x 8"	0.10 lbs.	1
#80877	5/16" x 4" x 6"	0.13 lbs.	1
#80878	3/8" x 4" x 6"	0.16 lbs.	1
#80879	3/8" x 10" x 12"	0.25 lbs.	1
#80880	1/2" x 4" x 6"	0.18 lbs.	1
#80881	1/2" x 10" x 12"	0.35 lbs.	1
#80882	5/8" x 6" x 8"	0.30 lbs.	1
#80883	5/8" x 10" x 12"	0.45 lbs.	1
#80884	3/4" x 6" x 8"	0.40 lbs.	1
#80885	3/4" x 10" x 12"	0.75 lbs.	1
#80886	7/8" x 6" x 8"	0.55 lbs.	1
#80887	7/8" x 10" x 12"	0.95 lbs.	1
#80888	1" x 8" x 10"	1.00 lbs.	1



**Rotary Percussion Masonry Drill Bits**

Item #	Size	Wt. lbs.	Qty.
<i>New</i> #81147	1/4" x 6"	0.10 lbs.	1
<i>New</i> #81148	1/2" x 1/4" x 6"	0.16 lbs.	1



**Rotary Hammer Bits With Stop**

Item #	Size	Wt. lbs.	Qty.
#80895	3/8" x 1-1/16"	0.20 lbs.	1
#80896	1/2" x 13/16"	0.25 lbs.	1
#80897	5/8" x 1-1/16"	0.30 lbs.	1
#80898	5/8" x 2-1/16"	0.35 lbs.	1

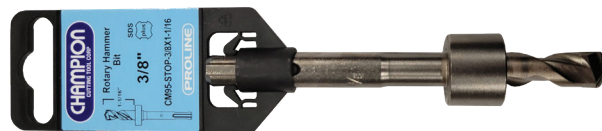

**Rotary Rebar Cutters**

Item #	Size	Wt. lbs.	Qty.
#80889	1/2"	0.70 lbs.	1
#80890	5/8"	0.90 lbs.	1
#80891	3/4"	1.25 lbs.	1
#80892	7/8"	1.20 lbs.	1
#80893	1"	1.35 lbs.	1
#80894	1-1/8"	1.55 lbs.	1



**Annular Cutter Bits**

Item #	Size (Diameter x Depth)	Wt. lbs.	Qty.
#80851	7/16" x 2"	0.20 lbs.	1
#80852	1/2" x 2"	0.25 lbs.	1
#80853	9/16" x 2"	0.25 lbs.	1
#80854	5/8" x 2"	0.30 lbs.	1
#80855	11/16" x 2"	0.30 lbs.	1
#80856	3/4" x 2"	0.30 lbs.	1
#80857	13/16" x 2"	0.40 lbs.	1
#80858	7/8" x 2"	0.40 lbs.	1
<i>New</i> #81651	15/16" x 1"	0.27 lbs.	1
#80859	15/16" x 2"	0.50 lbs.	1
#80860	1" x 2"	0.35 lbs.	1
#80861	1-1/16" x 2"	0.45 lbs.	1
#80862	1-1/4" x 2"	0.50 lbs.	1
#80863	1-1/2" x 2"	0.60 lbs.	1
#80864	2" x 2"	0.85 lbs.	1



**Carbide Tipped Hole Cutter Set**

Item #	Kit Includes	Wt. lbs.	Qty.
<i>New</i> #81427	9/16" 11/16" 13/16" 15/16" 1-1/16"	2.28 lbs.	1



**Tap And Die Kit**

Item #	Kit Includes	Wt. lbs.	Qty.
#80847	17 Machine Screws 17 Fractional Taps 1 Die stock 2 Tap Wrenches 1 Thread Pitch Gauge 1 Screwdriver	3.35 lbs.	1



**Step Reamer Set**

Item #	Wt. lbs.	Qty.
#80849	1.55 lbs.	1



**Maintenance Reamers Drill Bit - Brute SA80**

Item #	Size	Wt. lbs.	Qty.
<i>New</i> #81664	11/16"	0.37 lbs.	1
<i>New</i> #81665	15/16"	0.74 lbs.	1



**Hex Step Drill Bits - 1/4" Shank**

Item #	Type	Steps	Wt. lbs.	Qty.
#80865	HEX 1	13 - 1/8" to 1/2"	0.10 lbs.	1
#80866	HEX 13	13 - 1/4" to 1-1/8"	0.25 lbs.	1
#80867	HEX 3	9 - 1/4" to 3/4"	0.15 lbs.	1
#80868	HEX 4	12 - 3/16" to 7/8"	0.15 lbs.	1



**Magnetic Drill Presses**

Item #	Type	Wt. lbs.	Qty.
#80850	MiniBrute	37.30 lbs.	1
#80967	MightiBrute	42.30 lbs.	1



**Brutelube Cutting Fluid**

Item #	Size	Wt. lbs.	Qty.
<i>New</i> #81609	4oz	0.24 lbs.	12



**Brutelube Wax Lubricant**

Item #	Size	Wt. lbs.	Qty.
<i>New</i> #81610	2oz	0.18 lbs.	24



**Magnetic Hex Nutsetters**

Item #	Size	Wt. lbs.	Qty.
#80079	1/4"	0.05 lbs.	100
#80080	5/16"	0.06 lbs.	100
#80081	3/8"	0.08 lbs.	100



**Punch Set - Numbers**

Item #	Wt. lbs.	Qty.
#50469	0.80 lbs.	5



TOOLS  
**JACK STANDS**

**Sumner® Fold-A-Jack Pipe Stand**

Item #	Type	Weight Capacity	Height	Wt. lbs.	Qty.
#80052	Hi Jack	2,500	49"	25.0 lbs.	1



**Spring Creek™ Products Foldable Jack Stands**

Item #	Height	Weight Capacity	Wt. lbs.	Qty.
#80165	21" - 36"	2,500	17.40 lbs.	1
#80458	33" to 47"	2,500	24.10 lbs.	1



**Spring Creek™ Products Jack Stand**

Item #	Height	Weight Capacity	Wt. lbs.	Qty.
#80202	30" to 36"	2,500	25.24 lbs.	1



**Roller Head Attachment**

Item #	Accommodates Pipe	Weight Capacity	Fits Stand	Wt. lbs.	Qty.
#80203	1-1/4" to 24"	2,000	#80458	9.68 lbs.	1



**Roller Head Wheel Attachment**

Item #	Wt. lbs.	Qty.
#80801	8.64 lbs.	1



**Ball Transfer Head Attachment**

Item #	Weight Capacity	Wt. lbs.	Qty.
#80204	1,000	5.57 lbs.	1



**Extended "V" Head Attachment**

Item #	Fits Stand	Wt. lbs.	Qty.
#80802	#80458	11.36 lbs.	1





**Spring Creek™ Tape Measures**

Item #	Size	Type	Fraction	Wt. lbs.	Qty.
#47898	25' x 1"	Magnet	No	0.66 lbs.	6
#47899	25' x 1"	No Magnet - Rubber Coated	Yes	0.66 lbs.	6
#47900	33' x 1"	Magnet	No	0.77 lbs.	6
#47901	33' x 1"	No Magnet - Rubber Coated	Yes	0.77 lbs.	6



Magnet Style



Durable, non-slip, rubber coated ABS case for easy grip.

*New*

**Ruler With Conversion Chart**

Item #	Size	Finish	Wt. lbs.	Qty.
#81631	6"	Stainless	0.25 lbs.	100
#81632	12"	Stainless	0.26 lbs.	100
#81633	24"	Stainless	0.27 lbs.	100

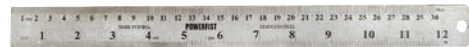

**Framing Square**

Item #	Type	Size	Wt. lbs.	Qty.
<i>New</i> #81081	Steel	16" x 24"	1.39 lbs.	1



*New*

**Speed Squares**

Item #	Type	Size	Wt. lbs.	Qty.
#81067	(A) Aluminum	12"	1.03 lbs.	6
#81080	(B) Plastic	7"	0.20 lbs.	125
#81068	(B) Plastic	12"	0.61 lbs.	50

A.

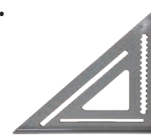

B.



**Sheet Metal Gauge**

Item #	Gauges	Finish	Wt. lbs.	Qty.
#50446	0-36	Stainless Steel	0.10 lbs.	25



**Welding Fillet Gauge**

Item #	Finish	Wt. lbs.	Qty.
#50445	Stainless Steel	0.35 lbs.	10



**Post Level**

Item #	Size	Finish	Wt. lbs.	Qty.
#80336	9"	Plastic	0.15 lbs.	1



**Line Level - Multi Pitch & Standard**

Item #	Wt. lbs.	Qty.
<i>New</i> #81066	0.04 lbs.	100



# TOOLS HAND TOOLS

## Malco® Turbo Shear Heavy-Duty

Item #	Type	Model #	Wt. lbs.	Qty.
#47853	Turbo Shear	TSHD	2.60 lbs.	4
#49148	Replacement Blades	TSHDRB	2.60 lbs.	1



## Malco® Fencing Pliers

Item #	Size	Model #	Wt. lbs.	Qty.
#49154	8"	FP1	1.00 lbs.	4
#49155	10"	FP2	1.00 lbs.	4



## 6-in-1 Screwdriver

Item #	Wt. lbs.	Qty.
#48164	0.27 lbs.	12



## Locking "C" Clamps

Item #	Size	Swivel	Wt. lbs.	Qty.
#70055	6"	No	1.62 lbs.	6
#80327	6"	Yes	0.62 lbs.	1 *



## Tinner Snips

Item #	Size	Wt. lbs.	Qty.
#80334	10"	1.40 lbs.	1
#80335	12"	2.10 lbs.	1



## Lock Jaw Pliers

Item #	Size	Wt. lbs.	Qty.
#80333	10"	1.00 lbs.	1



## Fence Pliers

Item #	Size	Wt. lbs.	Qty.
#80332	10"	1.00 lbs.	1



## Aviation Snips

Item #	Style	Color	Wt. lbs.	Qty.
#80133	Right	Green	0.88 lbs.	6
#80134	Left	Red	0.88 lbs.	6



T-Post Driver



Wire Gripper



Fence Stretcher

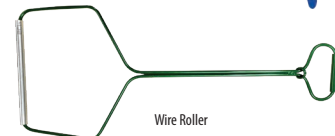

Wire Roller

Looking for additional tools?  
Check out the Fencing Tools  
section on page 30.

**Magnetic Pick Up Tool**

Item #	Wt. lbs.	Qty.
#50188	0.10 lbs.	36



**\$1,000+ Orders Ship For Free!!!!**



**Call your sales representative  
today to see if you qualify!  
1-866-651-6702**

*Some exclusions apply, offer subject to change without notice.*

**String And Reel - Pink**

Item #	Wt. lbs.	Qty.
#50587	0.58 lbs.	15



**Chalk Line With String Reel**

Item #	Wt. lbs.	Qty.
#80704	0.67 lbs.	12



**RevMark™ QuickDraw Markers**

Item #	Color	Box Style	Wt. lbs.	Qty.
#50647	Assorted	Display	0.35 lbs.	27
#50648	White	Display	0.35 lbs.	27
#80177	White	Replacement	0.01 lbs.	12



# TOOLS HAND TOOLS

## Adjust-O™ Magnet Squares

Item #	Size (Height x Width)	Wt. lbs.	Qty.
#80744	4-3/8" x 3-3/4"	1.01 lbs.	1
#80745	5-7/8" x 5-1/8"	2.15 lbs.	1



## Mini Magnet

Item #	Size (Height x Width)	Wt. lbs.	Qty.
#80743	2-5/16" x 2"	0.74 lbs.	1



## Inside/Outside Magnets

Item #	Type	Size (Height x Width)	Wt. lbs.	Qty.
#80741	Original	6-1/2" x 4-3/8"	1.70 lbs.	1
#80740	Adjustable	3-15/16" x 5-15/16"	1.70 lbs.	1



Original



Adjustable



## Magnetic Grasshopper

Item #	Wt. lbs.	Qty.
#80732	0.76 lbs.	1



## Portable Magvise

Item #	Wt. lbs.	Qty.
#80763	1.66 lbs.	1



## Grounding Magnetics

Item #	AMP	Wt. lbs.	Qty.
#80736	300	1.14 lbs.	1
#80737	500	1.67 lbs.	1



## Ground Hog Pliers

Item #	Wt. lbs.	Qty.
#80738	2.63 lbs.	1



## Locking C-Clamps - Round Tip

Item #	Size	Opening	Wt. lbs.	Qty.
#80752	7"	2-3/16"	0.59 lbs.	1
#80750	11-7/8"	4"	2.09 lbs.	1



## Locking C-Clamps - Swivel Tip

Item #	Size	Opening	Wt. lbs.	Qty.
#80753	7-3/8"	2-3/16"	0.65 lbs.	1
#80751	12-1/4"	4"	2.24 lbs.	1





**Utility Clamp Accessory Packs**

Item #	Fits (Clamp Models)	Wt. lbs.	Qty.
#80764	UE, UF, UG	0.57 lbs.	1
#80765	UM, UP	0.91 lbs.	1



**Utility Clamps**

Item #	Size (Opening x Thickness)	Clamp Pressure	Stop	Wt. lbs.	Qty.
#80754	4-1/2" x 5/8"	500 lbs.	Ring	1.03 lbs.	1
#80755	6-1/2" x 5/8"	500 lbs.	Ring	1.11 lbs.	1
#80756	8-1/2" x 5/8"	500 lbs.	Ring	1.19 lbs.	1
#80757	6-1/2" x 7/8"	1,000 lbs.	Spring	2.48 lbs.	1
#80758	12-1/2" x 1"	1,200 lbs.	Spring	4.14 lbs.	1



**Utility Clamp Kit**

Item #	Size (Opening x Thickness)	Clamp Pressure	Stop	Wt. lbs.	Qty.
#80759	8-1/2" x 1"	1,200 lbs.	Spring	3.60 lbs.	1



**Heavy-Duty Utility Clamps**

Item #	Size (Opening)	Wt. lbs.	Qty.
#80760	10-1/2"	6.12 lbs.	1
#80761	12-1/2"	6.75 lbs.	1
#80762	20-1/2"	8.38 lbs.	1



**Magtabs**

Item #	Style	Size (Height x Width)	Wt. lbs.	Qty.
#80739	Standard	2-1/2" x 3-13/16"	0.46 lbs.	1
#80742	Jumbo	4" x 5-3/16"	1.28 lbs.	1



**Magnetic V-Pads Kit**

Item #	Wt. lbs.	Qty.
#80746	0.91 lbs.	1



**Adjustable Pipe Pliers**

Item #	Size	Fits Pipe	Wt. lbs.	Qty.
#80748	9"	1" - 2"	0.93 lbs.	1
#80747	14-1/4"	1-1/2" - 2/1-2"	2.67 lbs.	1



**Mig Pliers**

Item #	Size	Wt. lbs.	Qty.
#80749	9-1/2"	0.74 lbs.	1



**Black Knives**

Item #	Size	Coating	Handle	Wt. lbs.	Qty.
#48636	(A) 4-1/2"	Black	Stainless Steel	0.38 lbs.	10
#48637	(B) 4-1/2"	Black	Stainless Steel	0.35 lbs.	10
#48638	(C) 4-1/2"	Black	Stainless Steel	0.35 lbs.	10
#48640	(D) 4-1/2"	Black	Stainless Steel	0.30 lbs.	10

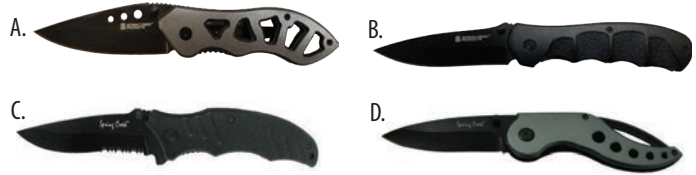

**Pakkawood Inlay Knives**

Item #	Size	Coating	Handle	Wt. lbs.	Qty.
#48647	(A) 4-1/2"	Satin	Stainless	0.32 lbs.	10
#48648	(B) 4-1/2"	Satin	Stainless	0.32 lbs.	10
#48649	(C) 4-1/2"	Satin	Stainless	0.32 lbs.	10
#48650	(D) 4-1/2"	Satin	Light burl wood	0.32 lbs.	10
#48651	(E) 4-1/2"	Satin	Light burl wood	0.32 lbs.	10



**Camo Knives**

Item #	Size	Coating	Handle	Wt. lbs.	Qty.
#48641	(A) 4-1/2"	Camo	Stainless Steel	0.32 lbs.	10
#48642	(B) 4"	Black	Stainless Steel	0.28 lbs.	10
#48643	(C) 4-1/2"	Black	Stainless Steel	0.30 lbs.	10
#48644	(D) 4-1/2"	Black	Stainless Steel	0.30 lbs.	10
#48645	(E) 5"	Camo	Stainless Steel	0.30 lbs.	10
#48646	(F) 4-1/2"	Black	Stainless Steel	0.32 lbs.	10

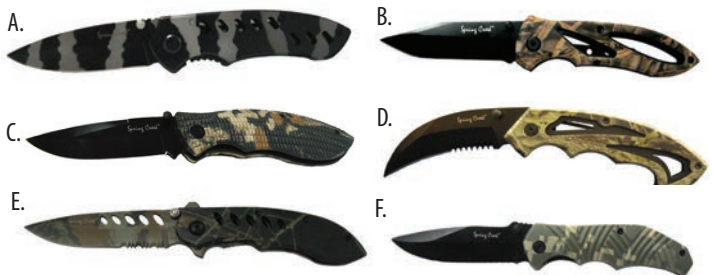

**Hunting Knife**

Item #	Size	Finish	Wt. lbs.	Qty.
#48652	8.85"	Stainless Steel	0.50 lbs.	1



**NEW ARRIVALS**  
*Shop Now*

See the newest additions on our website,  
[www.springcreekproducts.com](http://www.springcreekproducts.com)



**Multi-Tools**

Item #	Size	Type	Includes	Wt. lbs.	Qty.
#48633	(A) 3.2" - Black	4 in 1	Pliers, knife blade, bottle opener, carabiner	0.23 lbs.	12
#48634	(B) 3.8" - Metallic Gray	9 in 1	Pliers, screwdriver, knife blade, file, saws, bottle opener	0.58 lbs.	6
#48635	(C) 4.1" - Black	9 in 1	Pliers, screwdriver, knife blade, file, saws, bottle opener	0.63 lbs.	6

**Lightweight Safety Glasses**

Item #	Wt. lbs.	Qty.
#70190	0.07 lbs.	6



**Octane™ Safety Glasses**

Item #	Lens	Temple/Frame	Wt. lbs.	Qty.
#50024	Clear	Black	0.08 lbs.	12
#50025	Smoked	Black	0.08 lbs.	12
#50227	Smoked	Camo	0.08 lbs.	12



**Inhibitor® NXT Safety Glasses**

Item #	Lens	Temple/Frame	Wt. lbs.	Qty.
#50229	Clear	Clear	0.04 lbs.	12



**Commandos® Safety Glasses**

Item #	Lens	Temple/Frame	Wt. lbs.	Qty.
#50231	Clear	Black	0.04 lbs.	12
#50232	Gray	Black	0.04 lbs.	12
#50233	Camo	Amber	0.04 lbs.	12



**Boas® Safety Glasses**

Item #	Lens	Temple/Frame	Wt. lbs.	Qty.
#49435	Clear	Smoke/Clear	0.07 lbs.	12
#49436	Clear	Clear/Clear	0.07 lbs.	12
#49437	Smoked	Smoke/Smoke	0.07 lbs.	12



**SG-204-51 Safety Goggles**

Item #	Wt. lbs.	Qty.
#47961	0.19 lbs.	20



**Disposable Face Mask**

Item #	Wt. lbs.	Qty.
#80418	0.42 lbs.	50



**Face Shield – 8" x 12" Visor**

Item #	Wt. lbs.	Qty.
#47963	0.53 lbs.	1



**Ear Plugs**

Item #	Type	Wt. lbs.	Qty.
#47995	No Cord	0.004 lbs.	200
#47996	Corded	0.005 lbs.	200



**Ear Muff - Lightweight**

Item #	Wt. lbs.	Qty.
#47989	0.35 lbs.	12



**Premium Work Glove Double Palm 11"**

Grade A-B leather, Kevlar® stitching

Item #	Size	Wt. lbs.	Qty. (Pairs)
#50541	Medium	0.54 lbs.	12
#49686	Large	0.57 lbs.	12
#50542	X-Large	0.58 lbs.	12



**Goat Skin Glove 10-1/2"**

Grade A goat skin, Kevlar® stitching

Item #	Style	Size	Wt. lbs.	Qty. (Pairs)
#50104	3M Insulated	X-Large	0.42 lbs.	12
#50115	Non-Insulated	X-Large	0.33 lbs.	12



**Econo Work Glove Single Palm 10-1/2"**

Grade B-C leather

Item #	Wt. lbs.	Qty. (Pairs)
#49687	0.49 lbs.	12



**Oil Field Glove Double Palm 18 oz.**

Item #	Wt. lbs.	Qty. (Pairs)
#48663	0.19 lbs.	12



*New*

**Driver Gloves - Palm Lined**

Item #	Size	Wt. lbs.	Qty. (Pairs)
#81367	Medium	0.27 lbs.	12
#81360	Large	0.31 lbs.	12
#81152	X-Large	0.39 lbs.	12



*New*

**Mechanics Glove - Top Grain**

Item #	Size	Wt. lbs.	Qty. (Pairs)
#81495	Medium	0.21 lbs.	12
#81496	Large	0.24 lbs.	12
#81497	X-Large	0.25 lbs.	12
#81498	XX-Large	0.27 lbs.	12



*New*

**Mechanics Glove - Superior**

Item #	Size	Wt. lbs.	Qty. (Pairs)
#81604	Medium	0.24 lbs.	12
#81605	Large	0.25 lbs.	12
#81606	X-Large	0.28 lbs.	12
#81607	XX-Large	0.30 lbs.	12



*New*

**Premium Drive Glove - Super**

Item #	Size	Wt. lbs.	Qty. (Pairs)
#81660	Medium	0.18 lbs.	12
#81661	Large	0.18 lbs.	12
#81662	X-Large	0.19 lbs.	12
#81663	XX-Large	0.18 lbs.	12





### Premium Welding Glove 16"

Grade A leather, Kevlar® stitching

Item #	Size	Wt. lbs.	Qty. (Pairs)
#49685	Large	1.19 lbs.	10



### Premium Welding Glove 14"

Grade A leather, Kevlar® stitching

Item #	Size	Wt. lbs.	Qty. (Pairs)
#49694	Large	0.67 lbs.	10



### Econo Welding Glove 14"

Grade B-C leather

Item #	Size	Wt. lbs.	Qty. (Pairs)
#49695	Large	0.67 lbs.	10



### Econo Mig Welding Glove 12"

Grade A-B leather

Item #	Size	Wt. lbs.	Qty. (Pairs)
#49688	Large	0.54 lbs.	10



### Mig Welding Gloves

Kevlar® stitching

Item #	Style	Size	Wt. lbs.	Qty. (Pairs)
#81139	Fleece Lined	Large	0.63 lbs.	12
#81140	Fleece Lined	X-Large	0.70 lbs.	12
<i>New</i> #81639	-	Medium	0.37 lbs.	12
#81141	-	Large	0.36 lbs.	12
#81142	-	X-Large	0.39 lbs.	12



Fleece Lined



No Lining

### Stick Welding Gloves

Kevlar® stitching

Item #	Style	Size	Wt. lbs.	Qty. (Pairs)
#81133	Gold Grain	Large	0.64 lbs.	12
#81134	Gold Grain	X-Large	0.78 lbs.	12
#81135	Pearl Grain	Large	0.68 lbs.	12
#81136	Pearl Grain	X-Large	0.79 lbs.	12



### Tig Welding Gloves

Kevlar® stitching

Item #	Size	Wt. lbs.	Qty. (Pairs)
#81137	Large	0.28 lbs.	12
#81138	X-Large	0.30 lbs.	12



### Driver Gloves

Item #	Size	Wt. lbs.	Qty. (Pairs)
#81129	Medium	0.27 lbs.	12
#81130	Large	0.29 lbs.	12
#81131	X-Large	0.36 lbs.	12
#81132	XX-Large	0.37 lbs.	12



### Spring Creek™ Pigskin Leather Driving Glove

Item #	Size	Wt. lbs.	Qty. (Pairs)
#50539	Medium	0.33 lbs.	12
#47816	Large	0.28 lbs.	12
#50540	X-Large	0.28 lbs.	12



*New*

**Dock Bumpers**

Item #	Size	Wt. lbs.	Qty.
#81558	10" x 14"	37.00 lbs.	1
#81559	26" x 5"	30.50 lbs.	1

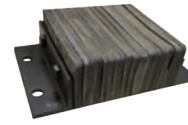

**Shop And Towel Rack**

Item #	Size (Length x Width x Height)	Finish	Wt. lbs.	Qty.
#80234	20" x 4" x 11"	Painted	2.40 lbs.	1



**High-Pressure Spray Gun**

Item #	Size	Wt. lbs.	Qty.
#50016	1 Quart	2.30 lbs.	10



***Sign Up To Order Online!***



It's simple and easy! Place orders, view product information, prices, and invoices.  
Contact your sales representative for more information at 866-651-6702

***Check out the website: [www.springcreekproducts.com](http://www.springcreekproducts.com)***

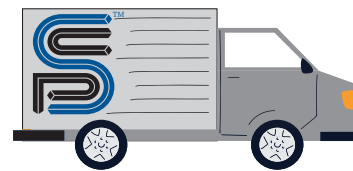

**Steel Strapping**

Item #	Size	Strength	WLL	Wt. lbs.	Pallet
#49219	3/4"	.025" high	2,770 lbs.	100 lbs.	13



**Steel Strap Clips**

Item #	Size	Wt. lbs.	Qty.
#48089	3/4"	0.01 lbs.	250



**Torque Stretch Film**

Item #	Size	Wt. lbs.	Qty.
#49383	18" x 1,500'	5.20 lbs.	4





All these items do not qualify for free freight.

**Ready Hour - 1 Week Food Supply**

Item #	Contains	Wt. lbs.	Qty.
<i>New</i> #81595	Cheesy Broccoli & Rice Soup Creamy Chicken Flavor Rice Homestyle Potato Soup Long Grain White Rice Mac & Cheese Maple Grove Oatmeal Orange Energy Drink Strawberry Creamy Wheat	10.1 lbs.	1



**Ready Hour - 4 Week Food Supply**

Item #	Contains	Wt. lbs.	Qty.
<i>New</i> #81596	Banana Chips Buttermilk Pancakes Cheesy Broccoli & Rice Soup Chili Mac Chocolate Pudding Creamy Chicken Flavor Rice Creamy Stroganoff Homestyle Potato Soup Long Grain White Rice Mac & Cheese Maple Grove Oatmeal Mushroom Rice Pilaf Orange Energy Drink Southwest Rice Strawberry Creamy Wheat	37.9 lbs.	1



**Ready Hour - 3 Month Food Supply**

Item #	Contains	Wt. lbs.	Qty.
<i>New</i> #81597	Banana Chips Buttermilk Pancakes Cheesy Broccoli & Rice Soup Chili Mac Chocolate Pudding Creamy Alfredo Pasta Creamy Chicken Flavor Rice Creamy Stroganoff Homestyle Potato Soup Honey Wheat Bread Mix Long Grain White Rice Mac & Cheese Maple Grove Oatmeal Mushroom Rice Pilaf Orange Energy Drink Powdered Whey Milk Rice Pudding Southwest Rice Spaghetti Strawberry Creamy Wheat	120.90 lbs.	1



**Ready Hour - Coffee**

Item #	Wt. lbs.	Qty.
<i>New</i> #81601	4.90 lbs.	1



**Ready Hour - Coffee Creamer 10#**

Item #	Wt. lbs.	Qty.
<i>New</i> #81598	3.27 lbs.	1



**Ready Hour - Fire Evacuation Mask**

Item #	Wt. lbs.	Qty.
<i>New</i> #81600	1.32 lbs.	1



# PROMO DISPLAYS / ACCESSORIES

Let **Spring Creek™ Products** customize a display for you!

Minimum order amount required.



### Assorted Welding Displays

Mix and match wire, rods, and accessories.



### Bale Spear Display

This display conveniently holds all the accessories your bale spears require.

Item #	Wt. lbs.	Qty.
#50003	37.50 lbs.	1



### Cut-To-Length Materials

Custom designed to your specifications.

- All material is deburred, cleaned, color-coded, barcoded and packaged
- Available in 2 foot or 4 foot sections

Item #	Wt. lbs.	Qty.
#80130	267.00 lbs.	1

Eye-catching | Profit Generator | Organized | Space Saver | Easy Inventory Tracking



### Hardware Display

This display houses multiple items in one convenient location. Perfect for one-stop shopping. Call a sales representative for more details.



### Letters and Numbers Display



### Rigging Display





### Gondola Display Unit - Metal Backing

- Freestanding display
- Available in 2ft or 4ft width
- Shelves are adjustable
- Can be combined for longer width

Item #	Color	Size	Wt. lbs.	Qty.
#80243	Beige	2'	38.00 lbs.	1
#80244	Black	2'	38.00 lbs.	1
#49669	Black	4'	170.0 lbs.	1
#50152	Beige	4'	170.0 lbs.	1



### Tip Bins And Cabinet

- Bins - 5" x 5-5/8" x 7-1/2" (4 Total)
- Break resistant containers in each cabinet
- Tip open to a 45°
- Removable containers
- Molded handle, Slots for labels

Polystyrene Cabinet:  
7-1/2" height x 23-5/8" length x 6-5/8" depth.  
Can stack or wall mount

### Bin Divider

5" L x 1/8" W x 7-1/2" H

Item #	Type	Wt. lbs.	Qty.
#49207	Tip Bin	7.00 lbs.	1
#49216	Bin Divider	0.20 lbs.	1
#49860	Replacement Bins	0.20 lbs.	1



### Peg Hooks

These hooks are great for any display! They have 8" of usable space to hang a variety of product.

Item #	Wt. lbs.	Qty.
#80325	0.10 lbs.	1



### Adjustable Replacement Feet For Gondola Display

Item #	Wt. lbs.	Qty.
#80724	0.12 lbs.	1

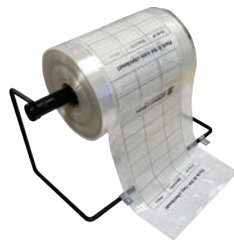

### Self Serve Bags

These bags are labeled with Item #, QTY, and Price for easy check out.

Item #	Type	Wt. lbs.	Qty.
#80987	Roll	8.77 lbs.	1,000 / Roll
#80988	Holder	1.75 lbs.	1

### Stackable Bins

Highly durable injection-molded plastic. Front, back, and side grips. Slot for labels, wide stacking ledges. Anti-slide locks - prevent from shifting. Rust and Corrosion resistant



#### Blue Stackable Bin - Small

Outer dimension: 5" H x 5-1/2" W x 11" D  
Bin load: 30 lbs., 1 divider slot



#### Blue Stackable Bin - Medium

Outer dimension: 7" H x 8" W x 15" D  
Bin load: 60 lbs., 3 divider slots



#### Blue Stackable Bin - Large

Outer dimension: 7" H x 16-1/2" W x 14-1/4" D  
Bin load: 75 lbs., 3 divider slots

Item #	Type	Wt. lbs.	Qty.
#50210	Small - Blue	0.75 lbs.	1
#50211	Medium - Blue	1.17 lbs.	1
#50241	Large - Blue	2.65 lbs.	1
#50384	Small - Dividers	0.17 lbs.	1
#50248	Large Dividers	0.44 lbs.	1



### Champion Drill Display

Counter top Drill Display, with or without drill bits.

Item #	Size	Wt. lbs.	Qty.
#80906	12-1/2" x 15" x 14"	15.0 lbs.	1
#80907	12-1/2" x 15" x 14"	25.0 lbs.	1 *

\*Display includes all drill bits.



Planning a special event for your customers? Let us fix you up with our promo gear!



We offer promotional gear and customized banners for your special occasions. Need something different? We may be able to help with that, too! Contact your salesman for more information today!





# SPRING CREEK<sup>TM</sup> PRODUCTS

---

## Terms & Conditions

### Pricing & Product Availability

Product availability varies and is subject to change at any time. Orders will be billed at the time of shipping. Sales may be subject to credit approval.

### Shipping Policy

Free shipping may be available for certain orders and special events. Any free freight offers are for the contiguous 48 states and are subject to change or cancellation at any time.

### Accessorial Charges or Services

Charges made for additional, special, or supplemental services which are normally over and above the line haul services. Inside delivery, residential delivery, sort/segregate, and lift gate are examples of accessorial charges. Deliveries requiring special services such as lift gate, weekend deliveries, call ahead scheduling, and expedited orders may be subject to additional fees.

### Redelivery

If a shipment is undeliverable through no fault of the seller or carrier, additional charges may apply for subsequential or attempted deliveries. Charges will vary based on the policies of the carrier.

### Shipping Claims

Mueller Metals, LLC is not liable for damaged or lost goods once they have left our warehouses. Risk of loss passes to the customer upon delivery of goods to the carrier. We will try to assist you with any claims you may have with a carrier within reason. We suggest you proceed with any claims by keeping detailed information including freight bills, shortages, photos of damage, or any other anomaly which you are claiming against the carrier.

### Sales Tax

Mueller Metals, LLC may charge sales taxes for merchandise depending on the address of your company, end user or reseller status, as well as the address of your payment source or delivery address, and as per state resale tax rules.

### Returns

Return requests for damaged material or errors must be pre-approved, processed, and returned to our warehouse within 60 days of the original invoice date. Additional information including photographs may be necessary for approval. A minimum restocking fee of 20% applies to all non-defective items which are returned, providing the goods are returned in the same condition as they were shipped. Return shipping fees for non-defective items are the responsibility of the sender. Shipping costs for pre-approved returns will be covered by Mueller Metals, LLC using the carrier of our choice. Please contact your sales rep prior to returning any goods for any reason. Goods returned for reasons other than defects may be subject to restocking fees and additional charges at the discretion of Mueller Metals, LLC. Goods that have been used, installed, modified, improperly stored, or handled may not qualify for refunds.

More terms and conditions on our website, [www.springcreekproducts.com/policy-terms](http://www.springcreekproducts.com/policy-terms)



## California's Safe Drinking Water and Toxic Enforcement Act of 1986

Some products sold by Mueller Metals, LLC and Spring Creek<sup>TM</sup> Products contain chemicals listed on the Prop 65 list of harmful chemicals. If you plan to do business in California, with a known California resident, or someone knowingly taking products into California, please contact us and we will be happy to provide you with the appropriate labels. Product information listed on our website, [www.springcreekproducts.com](http://www.springcreekproducts.com).

For more information, please visit [www.P65Warnings.ca.gov](http://www.P65Warnings.ca.gov).



# INDEX

## ABRASIVES

Chop Saw.....	106
Cut-Off Wheel.....	108
Flap Disc.....	105
Grindwheel.....	106
Wire Wheels.....	107

## AIRCRAFT CABLE.....66

## ANCHOR PLATES

Bolts.....	80
Plates.....	79
Shackles.....	71
Sleeves.....	80

## ANGLE IRON.....104

## BALE SPEARS.....52

## BALL MOUNTS.....63

## BBQ/GRILLING

Accessories.....	54-56
BBQ Thermometers.....	56
BBQ Wheels.....	56
Cookers.....	54
Handles.....	56

## BINDERS

Lever Load.....	76
Ratchet.....	76

## BLADES, SAW.....109-110

## BRUSHES

Wire Brush.....	84
Wire Wheel.....	107

## BODY PROTECTION

Ears Muffs/Plugs.....	122
Eyeware.....	122
Face Shield.....	122
Gloves.....	123-124
Welding Helmets.....	81-82

## BOLTS

Anchor.....	80
Cane.....	25
Carriage.....	23
Eyebolt.....	74
J-Bolt.....	21
Lag.....	21
U-Bolt.....	71

## CABLE GRIPS.....16

## CANE BOLTS.....25

## CAST IRON

Braces.....	45
Bottle Opener.....	47
Collar.....	37
Finial/Spear.....	37-38
Handles.....	43
Hinges.....	42
Horseshoe.....	46
Latches.....	43
Post Ball/Caps.....	37

Wheels.....	27-28
-------------	-------

## CHAIN/ACCESSORIES

Clevis Hooks.....	66
Grab Hooks.....	66-65
Keeper/Chain.....	26
Pails/Drum.....	66
Retainers.....	68
Transport.....	66

## CHAIN LINK FENCE ACC.....23

## CHIPPING HAMMERS.....84

## CHUTE PARTS.....23

## CLAMPS

C Clamps.....	117,119
L Clamps.....	120
Ground.....	83
Panel.....	23
Toggle.....	5

## CLIPS

Cable/Fence/Pipe.....	33-34
Rail.....	48

## COTTER PINS.....69

## CUT-TO-LENGTH

Angle Iron.....	104
Expanded Metal.....	103
Flat Bar.....	104
Square Bar.....	104
Sq/Rect Tube.....	104
Rebar.....	103
Round Bar.....	103
Threaded Rod.....	103

## DECORATIVE

Bottle Openers/Catchers.....	47
Coat Hooks.....	46
Braces/Brackets.....	45-46
Handles.....	39,43-44
Horseshoes.....	46

## DISPLAYS.....127-128

## DOCK BUMPERS.....125

## DOOR/GATE HARDWARE

Doors/Knobs.....	77
Door Track.....	29

## DOUBLE R-PINS.....70

## DRILL BITS.....111-114

## ELBOWS, PIPE.....31

## EXPANDED METAL.....103

## FARM/RANCH

Fence Clips.....	34-34
Chain Keeper/Chain.....	26
Chute/Panel Parts.....	23
Drop Pin.....	24
Pipe Panel Pals.....	32
Plastic Plugs.....	34
Post Caps.....	34-37
Striker Plate.....	7

## FENCE CLIPS.....33

## FENCING TOOLS

Fence Pliers.....	117
Fence Stretchers.....	30
T-Post Driver.....	30
T-Post Puller.....	30
Wire Gripper.....	30

## FINIALS.....37-38

## FIRE PITS.....55

## FLAT BAR.....104

## FLAT CAPS.....35-36

## GATE WHEEL.....27

## GLOVES

Oilfield.....	123
Leather.....	123-124
Welding.....	124

## GRAB HOOKS.....65

## GRILLING.....54-56

## GRINDWHEELS.....106

## HAND FORGED.....39-41

## HANDRAIL.....48

## HAND TOOLS

Brushes.....	84
Chipping Hammers.....	84
Cutters.....	117
Pliers.....	84,117
Snips.....	117

## HANDLES.....39,43-44,56

## HELMETS.....81-82

## HILLSIDE WASHERS.....78

## HINGES

Adjustable, Barrel.....	14
Barrel.....	11-12
Bat Wing.....	13
Bullet.....	9-10
Flag.....	13
Flat.....	8
Gate.....	11
Hasp & Staple.....	20
Heavy-duty.....	15
J-Bolt.....	21
Lag Pin.....	21
Male/Female.....	21-22
Piano Hinge.....	8
Pipe Sleeve.....	17
Ring Adapters.....	18
Round.....	11-12
Spring.....	16
Square.....	12
Strap.....	19-20
Tear Drop.....	15
Winged.....	13

## HINGE ADAPTERS.....18

## HITCHPINS.....70

## HOOKS

Clevis.....	65
Coat.....	46
Grab.....	65
Rope.....	71
S.....	71
Trailer.....	64
Turnbuckle.....	73

## HORSE STALL CHANNEL.....51

## JACK STANDS.....115

## J-BOLTS.....21

## KEYPAD MOUNTS.....25

## KITS

Bird Bath Kits.....	55
Firepit Weld Kits.....	55
Tractor Seat Bar Stool Kit.....	47
Trailer Bar Kits.....	5

## KNIVES.....121

## LANDSCAPE.....52

## LASHING RINGS.....67-68

## LATCHES, GATE

Bar Gate.....	3
Bolt.....	4
Cowboy.....	6
Gravity.....	6
Horseshoe.....	1
Lockable.....	7
Slam Action.....	3
Spring.....	1-3
Stall.....	3
Toggle Clamp.....	5
Trailer Bar Kits.....	5
Two-Way Lockable.....	6

## LATCH KEEPERS.....7

## LEVELS.....116

## LETTERS/NUMBERS.....50

## LIGHTS.....57-62

## LINCHPINS.....69

## LOCK BOXES.....32

## MALCO®.....117

## METAL ART

Cooking.....	54
Letter/Number.....	50
Signs.....	49
Tractor Seats.....	47

## METAL DEVIL®.....109

## METAL DOORS.....77

## MOUNTING BRACKETS

Braces.....	45
Mending Plates.....	46
Panels.....	37
Purlin Angle Clip.....	79
Purlin Chairs.....	79
Rail.....	48



Weld Plates.....	90-101	Snaps.....	69	<b>STRONGHAND.....</b>	<b>119-120</b>	Clamp.....	83
<b>ORNAMENTALS.....</b>	<b>38</b>	Straps.....	75-76	<b>T-POST DRIVER .....</b>	<b>30</b>	Cut-To-Length.....	103-104
<b>PANEL CLAMPS.....</b>	<b>23</b>	Turnbuckles.....	73	<b>T-POST PULLER.....</b>	<b>30</b>	Electrode Holder.....	83
<b>PINS</b>		<b>RING ADAPTERS.....</b>	<b>18</b>	<b>TANK HEADS.....</b>	<b>55</b>	Glove.....	124
Cotter.....	69	<b>ROOF JACKS.....</b>	<b>77</b>	<b>TAPE MEASURES.....</b>	<b>116</b>	Hammers.....	84
Double R.....	70	<b>ROPE.....</b>	<b>75</b>	<b>TARGET SHOOTING.....</b>	<b>53</b>	Helmet.....	81-82
Drop/Corral.....	24	<b>ROUND BAR.....</b>	<b>103</b>	<b>TIE LOOPS.....</b>	<b>68</b>	Jack Stands.....	115
Hitch.....	70	<b>ROUND TUBE.....</b>	<b>103</b>	<b>THERMOMETERS.....</b>	<b>56</b>	Magnets.....	84
Linch.....	69	<b>SAFETY GEAR.....</b>	<b>122-124</b>	<b>THREADED ROD.....</b>	<b>103</b>	Pipe Guide.....	89
R.....	70	<b>SCREWS</b>		<b>TOOLS</b>		Regulators.....	86-87
Snapper.....	69	Fence/Lag Bolts.....	34	Champion Tools.....	111-114	Rod.....	88
<b>PIPE CONNECTORS.....</b>	<b>31</b>	Roofing Screws.....	78	Fencing.....	117	Soapstone.....	83
<b>PIPE PANEL PALS.....</b>	<b>32</b>	Screw Eye Bolt.....	74	Hand Tools.....	116-118	Striker.....	83
<b>PIPE GUIDES.....</b>	<b>89</b>	Trailer.....	63	Stronghand.....	119-120	Tab/Plate.....	90-101
<b>PLASTIC TUBING PLUGS.....</b>	<b>34</b>	<b>SNAPS.....</b>	<b>72</b>	Welding.....	83-84	Tools.....	83-84
<b>POST CAPS.....</b>	<b>34-37</b>	<b>SNAPPER PINS.....</b>	<b>69</b>	<b>TORCH TIPS.....</b>	<b>85</b>	Torch Tip.....	85
<b>POWER TOOLS</b>		<b>SPEARS/FINIALS.....</b>	<b>38</b>	<b>TRACK, OVERHEAD.....</b>	<b>29</b>	Wire.....	88
Circular Saws.....	109	<b>SPRAY GUN.....</b>	<b>125</b>	<b>TRACK, WHEELS.....</b>	<b>29</b>	<b>WHEELS</b>	
TurboShear.....	117	<b>SPRINGS</b>		<b>TRACTOR SEAT.....</b>	<b>47</b>	Caster.....	29
<b>PROMO GEAR.....</b>	<b>127-129</b>	Assorted Spring.....	16	<b>TRAILER</b>		Cast Iron/BBQ.....	27-28
<b>PROPANE TORCH.....</b>	<b>53</b>	Handle.....	44	Balls.....	63	Door Track.....	29
<b>PUNCH PLATES.....</b>	<b>80</b>	Torsion.....	64	Fender.....	63	Gate Wheels.....	27
<b>PURLIN CLIPS.....</b>	<b>79</b>	<b>SQUARE BAR.....</b>	<b>104</b>	Jacks.....	65	Rubber Guide Roller.....	27
<b>R-PINS.....</b>	<b>70</b>	<b>SQUARE TUBE.....</b>	<b>104</b>	Lights.....	57-62	V-Groove.....	28
<b>RAIN GAUGE.....</b>	<b>53</b>	<b>STAKE POCKET.....</b>	<b>64</b>	<b>TUBING, PLUGS.....</b>	<b>34</b>	<b>WHEEL BOXES.....</b>	<b>28</b>
<b>RATCHET TIE-DOWNS.....</b>	<b>75-76</b>	<b>STAIRSTEP.....</b>	<b>80</b>	<b>TURNBUCKLES.....</b>	<b>73</b>	<b>WINCHES.....</b>	<b>76</b>
<b>READY HOUR MEALS.....</b>	<b>126</b>	<b>STORE DISPLAYS.....</b>	<b>127-128</b>	<b>V-GROOVE WHEELS.....</b>	<b>28</b>	<b>WIRE</b>	
<b>REBAR.....</b>	<b>103</b>	<b>STRAPPING/CLIP.....</b>	<b>125</b>	<b>WEDGE ANCHORS.....</b>	<b>78</b>	Wire Brush.....	107
<b>RECTANGULAR TUBE.....</b>	<b>104</b>	<b>STRAPS</b>		<b>WELD STUDS.....</b>	<b>79</b>	Wire Wheel.....	107
<b>RIGGING HARDWARE</b>		Bungee Cord.....	75	<b>WELD TABS.....</b>	<b>90-101</b>		
Chain.....	66	Ratchet.....	75-76	<b>WELDING</b>			
Eyebolts.....	74	Winch.....	76	Abrasive.....	105-110		
Lashing Rings.....	67-68	Zip Ties.....	75	Brushes.....	84		
Pins.....	68-70	<b>STRETCH FILM.....</b>	<b>125</b>	Cable Connector.....	83		

NOTES:

# ITEM NUMBER - PAGE NUMBER

Item # - Page #	Item # - Page #	Item # - Page #	Item # - Page #	Item # - Page #	Item # - Page #	Item # - Page #	Item # - Page #	Item # - Page #	Item # - Page #
45911 - 79	46199 - 50	47585 - 21	47853 - 117	48048 - 65	48297 - 104	48433 - 75	48634 - 121	48888 - 72	
45912 - 79	46393 - 49	47586 - 21	47854 - 29	48049 - 65	48298 - 104	48434 - 75	48635 - 121	48890 - 72	
45919 - 33	46442 - 33	47593 - 3	47856 - 13	48059 - 34	48300 - 104	48452 - 48	48636 - 121	48891 - 71	
45938 - 35	46450 - 35	47595 - 35	47857 - 13	48072 - 15	48301 - 104	48457 - 16	48637 - 121	48892 - 71	
45940 - 35	46451 - 35	47596 - 35	47869 - 13	48080 - 29	48303 - 104	48461 - 80	48638 - 121	48893 - 71	
45942 - 35	46452 - 35	47597 - 35	47870 - 13	48081 - 29	48304 - 103	48462 - 80	48640 - 121	48894 - 71	
45943 - 35	46488 - 16	47598 - 35	47882 - 75	48082 - 29	48306 - 103	48463 - 80	48641 - 121	48895 - 71	
45944 - 35	46489 - 16	47599 - 35	47888 - 76	48089 - 125	48307 - 103	48485 - 78	48642 - 121	48896 - 72	
45945 - 35	46586 - 33	47605 - 35	47889 - 76	48115 - 8	48309 - 103	48486 - 78	48643 - 121	48897 - 72	
45946 - 35	46597 - 33	47606 - 35	47890 - 75	48116 - 8	48310 - 103	48487 - 78	48644 - 121	48898 - 72	
45947 - 35	46598 - 33	47607 - 35	47891 - 76	48117 - 8	48312 - 103	48488 - 78	48645 - 121	48899 - 72	
45948 - 35	46640 - 16	47608 - 35	47892 - 76	48145 - 7	48313 - 103	48489 - 78	48646 - 121	48900 - 72	
45949 - 35	46641 - 16	47609 - 35	47893 - 76	48165 - 117	48315 - 103	48490 - 78	48647 - 121	48901 - 72	
45950 - 35	46990 - 2	47619 - 3	47894 - 76	48195 - 67	48316 - 103	48491 - 78	48648 - 121	48902 - 72	
45951 - 35	46994 - 33	47623 - 30	47895 - 76	48196 - 67	48318 - 103	48492 - 78	48649 - 121	48903 - 72	
45952 - 35	46995 - 33	47638 - 10	47896 - 66	48197 - 67	48319 - 103	48493 - 78	48650 - 121	48904 - 71	
46065 - 54	46996 - 33	47639 - 10	47897 - 66	48198 - 67	48321 - 103	48494 - 78	48651 - 121	48905 - 71	
46116 - 54	47016 - 1	47640 - 12	47898 - 116	48206 - 6	48322 - 104	48495 - 78	48652 - 121	48906 - 71	
46118 - 49	47017 - 3	47641 - 12	47899 - 116	48207 - 20	48324 - 104	48496 - 78	48657 - 24	48907 - 71	
46119 - 49	47018 - 3	47642 - 12	47900 - 116	48208 - 6,20,43	48325 - 104	48497 - 78	48658 - 24	48908 - 71	
46141 - 47	47019 - 10	47643 - 13	47901 - 116	48209 - 43	48327 - 104	48498 - 78	48660 - 21	48915 - 71	
46149 - 49	47021 - 52	47644 - 13	47902 - 29	48217 - 9	48328 - 104	48499 - 78	48663 - 123	48916 - 71	
46155 - 49	47022 - 89	47645 - 11	47904 - 103	48218 - 9	48330 - 104	48500 - 78	48713 - 9	48917 - 71	
46158 - 50	47023 - 89	47646 - 11	47905 - 103	48219 - 9	48331 - 104	48501 - 78	48785 - 5	48918 - 71	
46159 - 50	47024 - 89	47647 - 11	47935 - 30	48220 - 10	48333 - 104	48502 - 78	48786 - 5	48919 - 71	
46160 - 50	47025 - 89	47666 - 88	47937 - 89	48236 - 10	48334 - 104	48503 - 78	48803 - 22	48920 - 71	
46161 - 50	47026 - 89	47667 - 52	47939 - 21	48239 - 44,56	48336 - 104	48504 - 78	48804 - 22	48954 - 72	
46162 - 50	47040 - 31	47671 - 1	47940 - 21	48247 - 104	48337 - 104	48505 - 78	48806 - 22	48988 - 23	
46163 - 50	47041 - 31	47675 - 33	47941 - 21	48249 - 104	48339 - 104	48506 - 78	48847 - 65	48989 - 23	
46164 - 50	47042 - 31	47676 - 13	47942 - 21	48250 - 104	48340 - 104	48507 - 78	48848 - 65	48990 - 23	
46165 - 50	47043 - 31	47677 - 26	47943 - 21	48252 - 104	48342 - 104	48508 - 78	48850 - 65	49016 - 66	
46166 - 50	47044 - 31	47685 - 3	47948 - 109	48253 - 104	48343 - 104	48509 - 78	48853 - 74	49017 - 66	
46168 - 50	47045 - 31	47686 - 3	47949 - 109	48255 - 104	48345 - 104	48510 - 78	48854 - 74	49018 - 66	
46169 - 50	47046 - 31	47687 - 96	47950 - 109	48259 - 104	48346 - 104	48511 - 78	48855 - 74	49019 - 66	
46170 - 50	47047 - 31	47688 - 96	47951 - 109	48261 - 104	48348 - 104	48512 - 78	48856 - 74	49020 - 22	
46171 - 50	47048 - 31	47689 - 96	47952 - 109	48262 - 104	48352 - 103	48513 - 78	48857 - 74	49021 - 22	
46172 - 50	47049 - 31	47690 - 67	47953 - 109	48264 - 104	48354 - 103	48514 - 78	48858 - 74	49022 - 22	
46173 - 50	47050 - 12	47691 - 44,56	47957 - 31	48265 - 104	48355 - 103	48523 - 77	48859 - 74	49023 - 22	
46174 - 50	47051 - 12	47695 - 7	47958 - 31	48267 - 104	48357 - 103	48524 - 77	48860 - 74	49026 - 78	
46175 - 50	47052 - 8	47696 - 7	47959 - 16	48271 - 104	48358 - 103	48525 - 77	48861 - 74	49027 - 78	
46176 - 50	47053 - 8	47711 - 6	47961 - 122	48273 - 104	48360 - 103	48526 - 6	48862 - 74	49028 - 33	
46177 - 50	47054 - 8	47716 - 89	47963 - 122	48274 - 104	48361 - 34	48534 - 88	48869 - 73	49087 - 73	
46178 - 50	47055 - 8	47717 - 89	47989 - 122	48276 - 104	48362 - 109	48535 - 88	48870 - 73	49088 - 73	
46179 - 50	47056 - 8	47718 - 89	47995 - 122	48277 - 104	48371 - 15	48540 - 88	48871 - 73	49089 - 73	
46180 - 50	47057 - 8	47722 - 11	47996 - 122	48279 - 104	48372 - 15	48553 - 88	48872 - 73	49090 - 73	
46181 - 50	47058 - 8	47750 - 3	48029 - 109	48280 - 104	48373 - 15	48576 - 88	48873 - 73	49091 - 73	
46183 - 50	47059 - 8	47751 - 3	48036 - 14	48282 - 104	48374 - 15	48595 - 6	48874 - 73	49092 - 73	
46184 - 50	47061 - 28	47768 - 13	48037 - 14	48283 - 104	48405 - 34	48612 - 56	48875 - 73	49093 - 73	
46189 - 50	47062 - 28	47769 - 13	48038 - 29	48285 - 104	48411 - 28	48613 - 56	48877 - 71	49094 - 73	
46190 - 50	47088 - 12	47779 - 106	48040 - 31	48286 - 104	48419 - 75	48614 - 56	48880 - 71	49095 - 73	
46191 - 50	47089 - 12	47811 - 11	48041 - 31	48288 - 104	48421 - 75	48627 - 29	48881 - 71	49096 - 73	
46192 - 50	47117 - 2	47816 - 124	48042 - 31	48289 - 104	48422 - 75	48628 - 29	48882 - 71	49097 - 71	
46194 - 50	47118 - 11	47820 - 6	48043 - 31	48291 - 104	48423 - 75	48629 - 29	48884 - 71	49103 - 44	
46195 - 50	47135 - 8	47821 - 27	48044 - 31	48292 - 104	48429 - 75	48630 - 29	48885 - 71	49104 - 1	
46196 - 50	47339 - 2	47822 - 27	48046 - 65	48294 - 104	48430 - 75	48631 - 6	48886 - 72	49105 - 2	
46198 - 50	47584 - 21	47823 - 27	48047 - 65	48295 - 104	48432 - 75	48633 - 121	48887 - 72	49106 - 4	

# ITEM NUMBER - PAGE NUMBER

Item # - Page #	Item # - Page #	Item # - Page #	Item # - Page #	Item # - Page #	Item # - Page #	Item # - Page #	Item # - Page #	Item # - Page #
49113 - 80	49369 - 66	49499 - 75	49797 - 73	49893 - 65	49995 - 12	50076 - 10	50181 - 11	50311 - 19
49114 - 27	49370 - 3	49501 - 21	49798 - 73	49894 - 65	49997 - 78	50077 - 34	50182 - 52	50312 - 19
49116 - 80	49383 - 125	49503 - 27,56	49802 - 8	49895 - 65	49998 - 17	50078 - 34	50188 - 118	50313 - 19
49120 - 95	49384 - 55	49504 - 27,56	49803 - 8	49896 - 65	49999 - 17	50079 - 34	50191 - 82	50314 - 20
49121 - 95	49385 - 55	49645 - 3	49805 - 44,56	49899 - 72	50001 - 66	50080 - 34	50192 - 17	50316 - 20
49122 - 95	49395 - 72	49646 - 3	49806 - 48	49901 - 72	50002 - 66	50081 - 34	50197 - 63	50318 - 80
49124 - 95	49396 - 72	49647 - 3	49807 - 48	49918 - 71	50003 - 127	50082 - 34	50200 - 9	50321 - 17
49126 - 71	49397 - 72	49649 - 3	49809 - 52	49919 - 71	50007 - 24	50083 - 34	50201 - 9	50326 - 80
49127 - 71	49398 - 72	49650 - 3	49810 - 52	49921 - 5	50008 - 26	50084 - 10	50202 - 9	50333 - 47
49128 - 71	49399 - 72	49654 - 17	49811 - 52	49922 - 66	50009 - 26	50085 - 8	50203 - 9	50341 - 67
49130 - 14	49400 - 72	49655 - 17	49812 - 52	49923 - 66	50010 - 23	50086 - 15	50204 - 27	50344 - 22
49135 - 33	49401 - 72	49656 - 17	49813 - 52	49924 - 22	50012 - 68	50087 - 15	50205 - 27	50345 - 67
49148 - 117	49402 - 72	49659 - 66	49821 - 48	49925 - 22	50013 - 68	50091 - 29	50209 - 28	50346 - 1
49154 - 117	49403 - 72	49665 - 95	49822 - 25	49926 - 95	50014 - 68	50092 - 29	50210 - 128	50347 - 1
49155 - 117	49407 - 9	49667 - 96	49823 - 25	49942 - 70	50015 - 78	50102 - 69	50211 - 128	50348 - 1
49167 - 9	49408 - 9	49669 - 128	49824 - 25	49944 - 70	50016 - 125	50104 - 123	50222 - 33	50349 - 1
49173 - 29	49409 - 9	49680 - 64	49829 - 7	49945 - 70	50017 - 2	50105 - 81	50223 - 33	50350 - 34
49174 - 29	49410 - 9	49681 - 22	49830 - 7	49948 - 70	50018 - 8	50106 - 82	50224 - 33	50351 - 34
49175 - 29	49411 - 9	49682 - 22	49831 - 2	49949 - 70	50020 - 26	50107 - 82	50225 - 6	50352 - 34
49182 - 73	49413 - 9	49683 - 3	49832 - 2	49953 - 70	50021 - 26	50108 - 31	50227 - 122	50353 - 34
49183 - 73	49414 - 9	49685 - 124	49835 - 2	49956 - 69	50022 - 64	50109 - 31	50228 - 78	50354 - 34
49196 - 80	49415 - 9	49686 - 123	49836 - 1	49957 - 69	50023 - 92	50110 - 67	50229 - 122	50380 - 1
49198 - 44,56	49416 - 9	49687 - 123	49837 - 1	49958 - 69	50024 - 122	50111 - 52	50231 - 122	50381 - 1
49205 - 66	49417 - 9	49688 - 124	49838 - 44,56	49959 - 69	50025 - 122	50112 - 52	50232 - 122	50383 - 1
49207 - 128	49418 - 9	49690 - 68	49840 - 80	49960 - 69	50026 - 47	50115 - 123	50233 - 122	50384 - 128
49216 - 128	49427 - 4	49694 - 124	49841 - 33	49963 - 68	50030 - 77	50118 - 3	50241 - 128	50388 - 79
49218 - 35	49428 - 44	49695 - 124	49842 - 80	49964 - 26	50031 - 77	50119 - 26	50248 - 128	50390 - 36
49219 - 125	49429 - 7	49697 - 64	49843 - 47	49965 - 81	50032 - 77	50121 - 74	50250 - 80	50391 - 68
49328 - 2	49430 - 7	49709 - 28	49844 - 28	49966 - 81	50033 - 77	50122 - 66	50261 - 22	50392 - 7
49333 - 46	49431 - 68	49716 - 96	49847 - 92	49967 - 81	50035 - 77	50128 - 13	50263 - 56	50393 - 7
49334 - 46	49432 - 44	49717 - 79	49848 - 16	49968 - 81	50037 - 77	50131 - 89	50264 - 22	50400 - 27,56
49335 - 46	49434 - 64	49718 - 79	49852 - 69	49969 - 47	50038 - 77	50134 - 3	50265 - 22	50414 - 55
49336 - 43	49435 - 122	49719 - 79	49853 - 69	49970 - 21	50039 - 77	50135 - 24	50267 - 22	50415 - 55
49337 - 43	49436 - 122	49720 - 79	49854 - 69	49971 - 26	50042 - 17	50136 - 16	50268 - 64	50416 - 44
49338 - 43	49437 - 122	49721 - 79	49855 - 69	49972 - 24	50045 - 116	50137 - 16	50269 - 64	50417 - 4
49339 - 46	49444 - 35	49722 - 79	49856 - 69	49973 - 26	50046 - 116	50140 - 2	50270 - 64	50418 - 4
49340 - 46	49445 - 35	49723 - 79	49857 - 69	49974 - 26	50054 - 77	50141 - 7	50272 - 17	50423 - 20
49341 - 46	49450 - 44,56	49724 - 79	49858 - 52,69	49975 - 24	50055 - 77	50142 - 66	50278 - 80	50424 - 19
49342 - 46	49451 - 32	49725 - 79	49860 - 128	49976 - 22	50058 - 79	50143 - 66	50279 - 36	50425 - 43
49345 - 21	49452 - 32	49726 - 79	49869 - 24	49977 - 22	50059 - 79	50144 - 66	50280 - 36	50426 - 71
49346 - 21	49453 - 32	49727 - 79	49870 - 24	49978 - 22	50060 - 10	50145 - 17	50281 - 36	50427 - 33
49347 - 21	49454 - 32	49730 - 29	49873 - 74	49979 - 94	50061 - 16	50146 - 53	50287 - 2	50428 - 46
49348 - 21	49455 - 95	49732 - 48	49874 - 33	49980 - 96	50062 - 10	50149 - 3	50289 - 37	50435 - 46
49351 - 21	49456 - 95	49737 - 6	49875 - 2	49981 - 96	50063 - 29	50152 - 128	50292 - 13	50436 - 46
49352 - 21	49457 - 21	49744 - 23	49876 - 26	49982 - 96	50064 - 29	50153 - 11	50293 - 11	50437 - 45
49353 - 21	49458 - 21	49748 - 23	49877 - 78	49983 - 96	50065 - 19	50154 - 19	50294 - 1	50438 - 45
49354 - 21	49460 - 19	49750 - 24	49878 - 78	49984 - 96	50066 - 19	50155 - 19	50295 - 1	50439 - 45
49357 - 21	49461 - 19	49751 - 9	49880 - 78	49985 - 96	50067 - 68	50156 - 19	50297 - 10	50440 - 34
49358 - 21	49467 - 33	49752 - 9	49881 - 78	49986 - 22	50068 - 11	50157 - 19	50298 - 20	50441 - 34
49360 - 21	49468 - 33	49753 - 10	49883 - 78	49987 - 22	50069 - 95	50162 - 34	50299 - 4	50442 - 34
49362 - 67	49478 - 7	49754 - 10	49884 - 78	49988 - 67	50070 - 3	50163 - 34	50302 - 44	50443 - 45
49364 - 4	49488 - 31	49768 - 16	49886 - 68	49989 - 68	50071 - 3	50164 - 34	50304 - 2	50444 - 96
49365 - 66	49491 - 56	49786 - 16	49888 - 68	49990 - 68	50072 - 10	50165 - 34	50305 - 1	50448 - 69
49366 - 66	49495 - 32	49787 - 16	49889 - 68	49991 - 68	50073 - 10	50168 - 8	50308 - 19	50449 - 69
49367 - 66	49496 - 32	49794 - 78	49890 - 65	49992 - 68	50074 - 10	50179 - 11	50309 - 19	50450 - 69
49368 - 66	49497 - 75	49796 - 23	49891 - 65	49994 - 12	50075 - 10	50180 - 11	50310 - 19	50451 - 70

# ITEM NUMBER - PAGE NUMBER

Item # - Page #	Item # - Page #	Item # - Page #	Item # - Page #	Item # - Page #	Item # - Page #	Item # - Page #	Item # - Page #	Item # - Page #
50452 - 70	50514 - 50	50660 - 1	70100 - 106	70156 - 105	70229 - 85	80010 - 32	80104 - 16	80193 - 67
50453 - 70	50524 - 70	50669 - 25	70101 - 108	70157 - 105	70230 - 85	80015 - 17	80111 - 74	80194 - 56
50454 - 70	50527 - 50	50670 - 27	70102 - 108	70158 - 105	70231 - 85	80017 - 108	80119 - 17	80195 - 17
50455 - 70	50528 - 50	50671 - 103	70103 - 108	70159 - 105	70232 - 85	80018 - 108	80121 - 17	80196 - 17
50456 - 70	50529 - 50	50672 - 103	70104 - 106	70160 - 83	70233 - 85	80019 - 108	80124 - 7,33	80197 - 17
50457 - 70	50530 - 23	50673 - 103	70105 - 106	70161 - 83	70234 - 85	80020 - 108	80125 - 7,33	80202 - 115
50458 - 70	50531 - 23	50680 - 47	70106 - 106	70162 - 84	70235 - 85	80021 - 108	80126 - 7,33	80203 - 115
50459 - 70	50532 - 33	50789 - 48	70107 - 106	70163 - 83	70236 - 85	80022 - 108	80127 - 7,33	80204 - 115
50460 - 70	50535 - 51	70022 - 84	70108 - 106	70164 - 88	70237 - 85	80023 - 108	80130 - 127	80206 - 17
50461 - 52	50536 - 51	70023 - 84	70109 - 106	70165 - 88	70238 - 85	80024 - 108	80131 - 80	80209 - 26
50462 - 3	50537 - 51	70024 - 83	70110 - 108	70166 - 88	70239 - 85	80025 - 108	80132 - 80	80212 - 75
50463 - 4	50539 - 124	70025 - 83	70111 - 108	70167 - 88	70240 - 85	80026 - 68	80133 - 117	80213 - 75
50464 - 4	50540 - 124	70026 - 84	70112 - 108	70168 - 88	70241 - 85	80027 - 68	80134 - 117	80227 - 28
50465 - 20	50541 - 123	70030 - 83	70113 - 106	70169 - 88	70242 - 85	80028 - 33	80136 - 32	80228 - 28
50466 - 5	50542 - 123	70031 - 83	70114 - 108	70170 - 88	70243 - 85	80029 - 11	80137 - 32	80229 - 66
50467 - 8	50548 - 47	70032 - 83	70115 - 108	70171 - 88	70244 - 85	80032 - 14	80138 - 32	80230 - 16
50468 - 8	50549 - 5	70033 - 86	70116 - 108	70172 - 88	70246 - 84	80033 - 14	80139 - 32	80231 - 67
50469 - 114	50553 - 3	70034 - 84	70117 - 108	70173 - 83	70247 - 83	80039 - 107	80140 - 32	80232 - 55
50470 - 50	50554 - 13	70035 - 84	70118 - 108	70174 - 83	70250 - 88	80045 - 68	80141 - 79	80234 - 125
50471 - 50	50559 - 44,56	70036 - 84	70119 - 108	70175 - 83	70252 - 82	80051 - 21	80142 - 31	80235 - 80
50472 - 50	50570 - 80	70037 - 84	70120 - 107	70176 - 88	70253 - 88	80052 - 115	80144 - 103	80236 - 13
50473 - 50	50571 - 5	70038 - 54,84	70121 - 107	70177 - 88	70254 - 81	80053 - 79	80145 - 103	80243 - 128
50474 - 50	50572 - 5	70039 - 54,84	70122 - 107	70178 - 88	70255 - 81	80054 - 79	80146 - 103	80244 - 128
50475 - 50	50573 - 5	70040 - 54,84	70123 - 107	70179 - 88	70256 - 86	80055 - 79	80147 - 103	80245 - 35
50476 - 50	50574 - 5	70043 - 82	70124 - 105	70180 - 88	70257 - 86	80061 - 9	80148 - 103	80246 - 36
50477 - 50	50575 - 5	70044 - 82	70125 - 105	70181 - 88	70258 - 86	80062 - 9	80149 - 103	80247 - 36
50478 - 50	50576 - 5	70045 - 82	70126 - 105	70182 - 88	70259 - 86	80063 - 9	80151 - 22	80248 - 79
50479 - 50	50577 - 5	70050 - 85	70127 - 105	70183 - 85	70260 - 86	80064 - 9	80153 - 22	80250 - 15
50480 - 50	50578 - 5	70051 - 85	70128 - 105	70184 - 85	70261 - 86	80065 - 9	80154 - 23	80251 - 13
50481 - 50	50585 - 79	70052 - 85	70129 - 105	70185 - 85	70262 - 86	80066 - 80	80155 - 23	80267 - 36
50482 - 50	50586 - 11	70053 - 85	70130 - 105	70186 - 85	70263 - 87	80072 - 71	80156 - 23	80268 - 36
50483 - 50	50587 - 118	70055 - 117	70131 - 105	70187 - 83	70264 - 86	80073 - 21	80158 - 35	80269 - 36
50484 - 50	50597 - 103	70056 - 84	70132 - 105	70188 - 83	70265 - 86	80077 - 26	80159 - 35	80270 - 36
50485 - 50	50598 - 103	70057 - 85	70133 - 105	70190 - 81122	70266 - 87	80078 - 17	80160 - 35	80271 - 6
50486 - 50	50599 - 103	70058 - 85	70134 - 105	70193 - 84	70267 - 86	80079 - 114	80161 - 35	80272 - 6
50487 - 50	50600 - 103	70059 - 85	70135 - 105	70194 - 84	70268 - 86	80080 - 114	80162 - 35	80273 - 30
50488 - 50	50601 - 103	70060 - 85	70136 - 105	70195 - 83	70269 - 86	80081 - 114	80163 - 35	80274 - 31
50489 - 50	50602 - 103	70063 - 85	70137 - 105	70196 - 83	70270 - 86	80082 - 79	80165 - 115	80275 - 31
50490 - 50	50603 - 103	70066 - 88	70138 - 105	70199 - 83	70272 - 54,84	80083 - 79	80166 - 36	80276 - 27
50491 - 50	50604 - 103	70067 - 88	70139 - 105	70200 - 83	70275 - 89	80084 - 79	80167 - 36	80277 - 15
50492 - 50	50605 - 103	70072 - 88	70140 - 105	70202 - 107	70276 - 89	80086 - 29	80168 - 36	80278 - 15
50493 - 50	50606 - 103	70073 - 88	70141 - 105	70203 - 107	70279 - 82	80088 - 76	80169 - 36	80279 - 15
50494 - 50	50607 - 103	70074 - 88	70142 - 105	70204 - 107	70280 - 85	80089 - 74	80170 - 36	80280 - 9
50495 - 50	50608 - 103	70075 - 88	70143 - 105	70205 - 107	70281 - 81	80090 - 8	80171 - 36	80281 - 9
50496 - 50	50619 - 33	70080 - 88	70144 - 105	70206 - 107	70282 - 81	80091 - 8	80172 - 36	80283 - 110
50497 - 50	50622 - 47	70081 - 88	70145 - 105	70211 - 83	70284 - 82	80092 - 8	80173 - 36	80284 - 110
50498 - 50	50631 - 26	70090 - 106	70146 - 105	70212 - 9	80000 - 55	80093 - 8	80174 - 36	80285 - 110
50499 - 50	50632 - 1	70091 - 106	70147 - 105	70213 - 9	80001 - 32	80094 - 8	80175 - 36	80286 - 110
50500 - 50	50635 - 24	70092 - 106	70148 - 105	70214 - 10	80002 - 32	80095 - 8	80176 - 36	80287 - 71
50501 - 50	50636 - 27	70093 - 106	70149 - 105	70215 - 10	80003 - 32	80096 - 8	80177 - 118	80289 - 71
50502 - 50	50639 - 6	70094 - 106	70150 - 105	70216 - 10	80004 - 32	80097 - 8	80178 - 8	80292 - 66
50503 - 50	50641 - 47	70095 - 106	70151 - 105	70217 - 11	80005 - 32	80098 - 8	80179 - 44	80293 - 63
50504 - 44,56	50642 - 47	70096 - 106	70152 - 105	70218 - 12	80006 - 32	80100 - 55	80187 - 82	80294 - 66
50511 - 79	50643 - 47	70097 - 106	70153 - 105	70226 - 84	80007 - 32	80101 - 17	80188 - 82	80295 - 63
50512 - 50	50647 - 118	70098 - 106	70154 - 105	70227 - 85	80008 - 32	80102 - 17	80189 - 82	80296 - 66
50513 - 50	50648 - 118	70099 - 106	70155 - 105	70228 - 85	80009 - 32	80103 - 17	80192 - 2	80299 - 63



# ITEM NUMBER - PAGE NUMBER

Item # - Page #	Item # - Page #	Item # - Page #	Item # - Page #	Item # - Page #	Item # - Page #	Item # - Page #	Item # - Page #	Item # - Page #
80304 - 63	80424 - 18	80507 - 93	80563 - 92	80619 - 90	80692 - 40	80763 - 119	80845 - 112	80905 - 110
80305 - 63	80425 - 18	80508 - 93	80564 - 92	80620 - 90	80693 - 39	80764 - 120	80846 - 112	80906 - 128
80306 - 63	80426 - 18	80509 - 93	80565 - 92	80621 - 90	80695 - 39	80765 - 120	80847 - 113	80907 - 128
80310 - 58	80427 - 18	80510 - 93	80566 - 92	80622 - 90	80698 - 28	80767 - 28	80848 - 111	80908 - 29
80312 - 62	80428 - 18	80511 - 93	80567 - 92	80623 - 90	80699 - 28	80768 - 66	80849 - 114	80909 - 111
80313 - 58	80429 - 18	80512 - 93	80568 - 92	80624 - 90	80700 - 65	80769 - 66	80850 - 114	80910 - 111
80319 - 63	80430 - 18	80513 - 93	80569 - 91	80625 - 36	80704 - 118	80770 - 13	80851 - 113	80911 - 111
80320 - 63	80431 - 18	80514 - 93	80570 - 91	80627 - 30	80705 - 12	80775 - 37	80852 - 113	80912 - 111
80321 - 63	80432 - 18	80515 - 93	80571 - 91	80628 - 30	80706 - 12	80776 - 37	80853 - 113	80913 - 111
80323 - 65	80433 - 18	80516 - 93	80572 - 91	80629 - 30	80707 - 12	80777 - 37	80854 - 113	80914 - 111
80325 - 128	80434 - 18	80517 - 90	80573 - 91	80630 - 30	80708 - 12	80778 - 37	80855 - 113	80915 - 111
80327 - 117	80435 - 18	80518 - 90	80574 - 91	80631 - 77	80709 - 12	80779 - 5	80856 - 113	80916 - 111
80332 - 117	80436 - 18	80519 - 90	80575 - 91	80633 - 66	80710 - 12	80787 - 110	80857 - 113	80917 - 111
80333 - 117	80437 - 18	80520 - 90	80576 - 91	80634 - 25	80711 - 10	80790 - 110	80858 - 113	80918 - 111
80334 - 117	80438 - 18	80521 - 90	80577 - 91	80635 - 25	80712 - 14	80799 - 45	80859 - 113	80919 - 111
80335 - 117	80440 - 5	80522 - 90	80578 - 91	80636 - 22	80713 - 14	80800 - 103	80860 - 113	80920 - 111
80336 - 116	80442 - 34	80523 - 90	80579 - 94	80638 - 12	80714 - 14	80801 - 115	80861 - 113	80921 - 111
80349 - 22	80443 - 34	80524 - 90	80580 - 94	80639 - 48	80715 - 12	80802 - 115	80862 - 113	80922 - 111
80351 - 8	80444 - 34	80525 - 90	80581 - 94	80640 - 48	80716 - 12	80803 - 80	80863 - 113	80923 - 111
80355 - 58	80445 - 46	80526 - 90	80582 - 94	80641 - 48	80717 - 12	80805 - 24	80864 - 113	80924 - 111
80358 - 58	80454 - 51	80527 - 90	80583 - 94	80642 - 48	80718 - 12	80806 - 55	80865 - 114	80925 - 111
80360 - 59	80455 - 51	80528 - 90	80584 - 94	80643 - 48	80719 - 14	80807 - 55	80866 - 114	80926 - 111
80363 - 32	80456 - 51	80529 - 90	80585 - 94	80650 - 41	80720 - 14	80808 - 55	80867 - 114	80927 - 111
80364 - 67	80457 - 80	80530 - 90	80586 - 94	80651 - 41	80721 - 12	80809 - 79	80868 - 114	80928 - 111
80366 - 60	80458 - 115	80531 - 90	80587 - 94	80652 - 41	80722 - 12	80810 - 43	80873 - 112	80929 - 111
80367 - 60	80459 - 51	80532 - 90	80588 - 94	80654 - 41	80723 - 30	80811 - 43	80874 - 112	80930 - 111
80368 - 60	80460 - 67	80533 - 92	80589 - 94	80655 - 40	80724 - 128	80812 - 42	80875 - 112	80931 - 111
80370 - 57	80474 - 27	80534 - 92	80590 - 94	80656 - 39	80725 - 70	80813 - 43	80876 - 112	80932 - 111
80372 - 64	80475 - 27	80535 - 92	80591 - 94	80657 - 41	80732 - 119	80814 - 42	80877 - 112	80933 - 111
80373 - 85	80476 - 80	80536 - 92	80592 - 94	80658 - 40	80736 - 119	80815 - 43	80878 - 112	80934 - 111
80374 - 85	80477 - 25	80537 - 92	80593 - 94	80659 - 39	80737 - 119	80816 - 43	80879 - 112	80935 - 111
80375 - 85	80478 - 37	80538 - 92	80594 - 94	80660 - 40	80738 - 119	80817 - 42	80880 - 112	80936 - 111
80376 - 85	80479 - 37	80539 - 92	80595 - 94	80661 - 40	80739 - 120	80818 - 42	80881 - 112	80937 - 111
80377 - 85	80480 - 37	80540 - 92	80596 - 94	80662 - 41	80740 - 119	80819 - 42	80882 - 112	80938 - 111
80378 - 85	80481 - 94	80541 - 92	80597 - 94	80663 - 40	80741 - 119	80820 - 43	80883 - 112	80939 - 111
80379 - 95	80482 - 94	80542 - 92	80598 - 94	80664 - 39	80742 - 120	80821 - 43	80884 - 112	80940 - 111
80380 - 96	80483 - 94	80543 - 92	80599 - 94	80665 - 41	80743 - 119	80824 - 103	80885 - 112	80941 - 111
80382 - 31	80484 - 94	80544 - 92	80600 - 94	80666 - 41	80744 - 119	80825 - 103	80886 - 112	80942 - 111
80384 - 24	80486 - 94	80545 - 92	80601 - 93	80667 - 39	80745 - 119	80826 - 103	80887 - 112	80943 - 111
80388 - 44,56	80487 - 94	80546 - 91	80602 - 93	80668 - 41	80746 - 120	80827 - 103	80888 - 112	80944 - 111
80393 - 66	80488 - 94	80547 - 91	80603 - 93	80670 - 40	80747 - 120	80828 - 103	80889 - 113	80945 - 111
80394 - 27	80489 - 94	80548 - 91	80604 - 93	80671 - 40	80748 - 120	80829 - 103	80890 - 113	80946 - 111
80395 - 34	80490 - 94	80549 - 91	80605 - 93	80672 - 40	80749 - 120	80830 - 103	80891 - 113	80947 - 111
80396 - 34	80492 - 94	80550 - 91	80606 - 93	80673 - 41	80750 - 119	80832 - 112	80892 - 113	80948 - 111
80398 - 67	80493 - 94	80551 - 91	80607 - 93	80674 - 40	80751 - 119	80833 - 112	80893 - 113	80949 - 111
80402 - 23	80494 - 94	80552 - 91	80608 - 93	80675 - 39	80752 - 119	80834 - 112	80894 - 113	80950 - 111
80403 - 53	80495 - 94	80553 - 91	80609 - 93	80676 - 40	80753 - 119	80835 - 112	80895 - 112	80951 - 111
80404 - 53	80497 - 94	80554 - 91	80610 - 93	80677 - 39	80754 - 120	80836 - 112	80896 - 112	80952 - 111
80405 - 53	80499 - 94	80555 - 91	80611 - 93	80678 - 40	80755 - 120	80837 - 112	80897 - 112	80953 - 111
80406 - 53	80500 - 94	80556 - 92	80612 - 93	80679 - 40	80756 - 120	80838 - 112	80898 - 112	80954 - 111
80407 - 53	80501 - 94	80557 - 92	80613 - 93	80680 - 40	80757 - 120	80839 - 112	80899 - 110	80955 - 111
80408 - 53	80502 - 94	80558 - 92	80614 - 93	80681 - 40	80758 - 120	80840 - 112	80900 - 110	80956 - 111
80411 - 79	80503 - 93	80559 - 92	80615 - 90	80682 - 41	80759 - 120	80841 - 112	80901 - 110	80957 - 111
80412 - 79	80504 - 93	80560 - 92	80616 - 90	80686 - 55	80760 - 120	80842 - 112	80902 - 110	80958 - 111
80415 - 11	80505 - 93	80561 - 92	80617 - 90	80690 - 14	80761 - 120	80843 - 112	80903 - 110	80959 - 111
80418 - 122	80506 - 93	80562 - 92	80618 - 90	80691 - 14	80762 - 120	80844 - 112	80904 - 110	80960 - 111

# ITEM NUMBER - PAGE NUMBER

Item # - Page #	Item # - Page #	Item # - Page #	Item # - Page #	Item # - Page #	Item # - Page #	Item # - Page #	Item # - Page #	Item # - Page #
80961 - 111	81029 - 50	81104 - 24	81171 - 102	81227 - 97	81283 - 99	81339 - 101	81407 - 61	81491 - 57
80962 - 111	81030 - 50	81105 - 24	81172 - 102	81228 - 97	81284 - 99	81340 - 101	81408 - 61	81492 - 57
80963 - 111	81031 - 50	81106 - 24	81173 - 102	81229 - 97	81285 - 99	81341 - 101	81409 - 61	81493 - 57
80964 - 111	81032 - 50	81110 - 5	81174 - 102	81230 - 97	81286 - 99	81342 - 101	81410 - 61	81494 - 57
80965 - 111	81033 - 50	81111 - 68	81175 - 102	81231 - 97	81287 - 99	81343 - 101	81411 - 61	81495 - 123
80966 - 111	81034 - 50	81112 - 25	81176 - 102	81232 - 98	81288 - 99	81344 - 101	81412 - 60	81496 - 123
80967 - 114	81035 - 50	81113 - 22	81177 - 102	81233 - 98	81289 - 99	81345 - 101	81413 - 60	81497 - 123
80968 - 89	81036 - 50	81117 - 33	81178 - 102	81234 - 98	81290 - 99	81346 - 101	81414 - 62	81498 - 123
80974 - 53	81037 - 50	81118 - 91	81179 - 102	81235 - 98	81291 - 99	81347 - 101	81415 - 62	81501 - 58
80975 - 44,56	81038 - 50	81119 - 91	81180 - 102	81236 - 98	81292 - 99	81348 - 101	81416 - 61	81502 - 75
80976 - 51	81039 - 50	81120 - 91	81181 - 102	81237 - 98	81293 - 99	81349 - 101	81417 - 61	81503 - 75
80977 - 17	81040 - 50	81121 - 92	81182 - 102	81238 - 98	81294 - 99	81350 - 101	81418 - 61	81537 - 51
80978 - 30	81041 - 50	81122 - 92	81183 - 102	81239 - 98	81295 - 99	81351 - 101	81420 - 61	81558 - 125
80979 - 29	81042 - 50	81123 - 92	81184 - 102	81240 - 98	81296 - 99	81352 - 101	81421 - 62	81559 - 125
80980 - 55	81043 - 50	81124 - 92	81185 - 102	81241 - 98	81297 - 99	81353 - 101	81422 - 61	81561 - 75
80981 - 56,64	81045 - 52	81125 - 92	81186 - 102	81242 - 98	81298 - 99	81354 - 101	81423 - 57	81565 - 4
80982 - 56,64	81047 - 17	81126 - 92	81187 - 102	81243 - 98	81299 - 99	81355 - 101	81424 - 5	81566 - 6
80983 - 56,64	81048 - 17	81127 - 28	81188 - 102	81244 - 98	81300 - 99	81356 - 101	81427 - 113	81567 - 25
80984 - 16	81053 - 56	81129 - 124	81189 - 102	81245 - 98	81301 - 99	81357 - 101	81428 - 80	81568 - 20
80986 - 17	81055 - 54	81130 - 124	81190 - 102	81246 - 98	81302 - 99	81358 - 101	81429 - 30	81569 - 20
80987 - 128	81056 - 54	81131 - 124	81191 - 97	81247 - 98	81303 - 99	81359 - 101	81432 - 102	81570 - 5
80988 - 128	81057 - 54	81132 - 124	81192 - 97	81248 - 98	81304 - 99	81360 - 123	81433 - 101	81571 - 41
80989 - 53	81058 - 54	81133 - 124	81193 - 97	81249 - 98	81305 - 99	81365 - 63	81443 - 59	81572 - 45
80991 - 64	81059 - 54	81134 - 124	81194 - 97	81250 - 98	81306 - 99	81367 - 123	81445 - 57	81573 - 45
80995 - 64	81060 - 54	81135 - 124	81195 - 97	81251 - 98	81307 - 99	81374 - 57	81446 - 57	81574 - 45
80998 - 66	81063 - 7	81136 - 124	81196 - 97	81252 - 98	81308 - 99	81375 - 57	81447 - 60	81575 - 45
80999 - 64	81064 - 56,85	81137 - 124	81197 - 97	81253 - 98	81309 - 99	81376 - 57	81448 - 60	81576 - 45
81000 - 64	81065 - 51	81138 - 124	81198 - 97	81254 - 98	81310 - 99	81377 - 57	81449 - 60	81577 - 45
81001 - 64	81066 - 116	81139 - 124	81199 - 97	81255 - 98	81311 - 99	81378 - 57	81452 - 95	81578 - 45
81002 - 64	81067 - 116	81140 - 124	81200 - 97	81256 - 98	81312 - 99	81379 - 57	81453 - 62	81579 - 46
81003 - 50	81068 - 116	81141 - 124	81201 - 97	81257 - 98	81313 - 99	81380 - 57	81455 - 61	81580 - 45
81004 - 50	81069 - 47	81142 - 124	81202 - 97	81258 - 98	81314 - 99	81381 - 57	81456 - 61	81581 - 45
81005 - 50	81070 - 47	81147 - 112	81203 - 97	81259 - 98	81315 - 99	81382 - 57	81457 - 59	81582 - 45
81006 - 50	81071 - 36	81148 - 112	81204 - 97	81260 - 98	81316 - 101	81383 - 57	81458 - 94	81583 - 45
81007 - 50	81072 - 36	81149 - 86	81205 - 97	81261 - 98	81317 - 101	81384 - 57	81459 - 107	81584 - 45
81008 - 50	81073 - 31	81150 - 38	81206 - 97	81262 - 98	81318 - 101	81385 - 58	81460 - 107	81585 - 45
81009 - 50	81075 - 53	81151 - 42	81207 - 97	81263 - 98	81319 - 101	81386 - 58	81461 - 107	81586 - 46
81010 - 50	81076 - 22	81152 - 123	81208 - 97	81264 - 98	81320 - 101	81387 - 58	81462 - 107	81587 - 46
81011 - 50	81077 - 22	81153 - 102	81209 - 97	81265 - 98	81321 - 101	81388 - 58	81463 - 107	81588 - 20
81012 - 50	81080 - 116	81154 - 102	81210 - 97	81266 - 98	81322 - 101	81389 - 58	81464 - 65	81589 - 4
81013 - 50	81081 - 116	81155 - 102	81211 - 97	81267 - 98	81323 - 101	81390 - 58	81465 - 65	81590 - 43
81014 - 50	81082 - 7	81156 - 102	81212 - 97	81268 - 98	81324 - 101	81391 - 58	81466 - 65	81591 - 68
81015 - 50	81083 - 64	81157 - 102	81213 - 97	81269 - 98	81325 - 101	81392 - 58	81467 - 65	81593 - 34
81016 - 50	81084 - 95	81158 - 102	81214 - 97	81270 - 98	81326 - 101	81393 - 59	81468 - 65	81594 - 34
81017 - 50	81085 - 16	81159 - 102	81215 - 97	81271 - 98	81327 - 101	81394 - 59	81469 - 65	81595 - 126
81018 - 50	81091 - 66	81160 - 102	81216 - 97	81272 - 99	81328 - 101	81395 - 59	81470 - 65	81596 - 126
81019 - 50	81092 - 64	81161 - 102	81217 - 97	81273 - 99	81329 - 101	81396 - 59	81471 - 65	81597 - 126
81020 - 50	81094 - 63	81162 - 102	81218 - 97	81274 - 99	81330 - 101	81397 - 59	81472 - 65	81598 - 126
81021 - 50	81095 - 63	81163 - 102	81219 - 97	81275 - 99	81331 - 101	81398 - 59	81473 - 65	81600 - 126
81022 - 50	81096 - 63	81164 - 102	81220 - 97	81276 - 99	81332 - 101	81399 - 60	81474 - 65	81601 - 126
81023 - 50	81097 - 30	81165 - 102	81221 - 97	81277 - 99	81333 - 101	81400 - 60	81476 - 74	81602 - 61
81024 - 50	81098 - 81	81166 - 102	81222 - 97	81278 - 99	81334 - 101	81401 - 62	81477 - 30	81604 - 123
81025 - 50	81099 - 81	81167 - 102	81223 - 97	81279 - 99	81335 - 101	81402 - 60	81478 - 30	81605 - 123
81026 - 50	81101 - 76	81168 - 102	81224 - 97	81280 - 99	81336 - 101	81403 - 60	81479 - 61	81606 - 123
81027 - 50	81102 - 21	81169 - 102	81225 - 97	81281 - 99	81337 - 101	81404 - 60	81481 - 57	81607 - 123
81028 - 50	81103 - 2	81170 - 102	81226 - 97	81282 - 99	81338 - 101	81405 - 60	81482 - 57	81608 - 107

# ITEM NUMBER - PAGE NUMBER

Item # - Page #	Item # - Page #	Item # - Page #
81609 - 114	00002 - 38	00173 - 37
81610 - 114	00003 - 38	00181 - 37
81612 - 57	00004 - 38	00182 - 37
81613 - 57	00005 - 38	00183 - 37
81615 - 57	00006 - 38	
81616 - 57	00007 - 38	
81618 - 59	00008 - 38	
81619 - 59	00009 - 38	
81620 - 111	00010 - 38	
81625 - 53	00011 - 38	
81626 - 53	00012 - 38	
81627 - 53	00013 - 38	
81628 - 53	00014 - 38	
81629 - 53	00015 - 37	
81630 - 53	00016 - 37	
81631 - 116	00017 - 37	
81632 - 116	00018 - 37	
81633 - 116	00019 - 37	
81639 - 124	00020 - 37	
81642 - 59	00021 - 37	
81643 - 61	00022 - 37	
81644 - 61	00023 - 37	
81645 - 61	00024 - 37	
81646 - 61	00025 - 37	
81647 - 61	00026 - 37	
81648 - 61	00027 - 36	
81649 - 61	00028 - 37	
81651 - 113	00029 - 36	
81652 - 88	00030 - 36	
81660 - 123	00031 - 36	
81661 - 123	00036 - 37	
81662 - 123	00039 - 37	
81663 - 123	00040 - 36	
81664 - 114	00075 - 38	
81665 - 114	00076 - 38	
81668 - 95	00077 - 38	
81669 - 95	00079 - 38	
81670 - 95	00080 - 38	
81671 - 95	00082 - 38	
81672 - 60	00083 - 38	
81673 - 76	00086 - 38	
81674 - 76	00087 - 38	
81675 - 76	00088 - 38	
81676 - 76	00093 - 38	
81677 - 58	00098 - 38	
81685 - 45	00099 - 38	
81686 - 45	00102 - 38	
81697 - 49	00104 - 38	
81698 - 49	00105 - 38	
81699 - 49	00106 - 37	
81700 - 59	00107 - 37	
81716 - 34	00108 - 37	
81725 - 60	00169 - 37	
81735 - 61	00170 - 37	
K0002 - 28	00171 - 37	
00001 - 38	00172 - 37	



# SPRING CREEK™ PRODUCTS

Welcome to Spring Creek™ Products!  
We strive to offer great products, selection, and service at competitive prices. "I personally guarantee your satisfaction".



*Fred Mueller*

## Meet the Sales Team



*Jamie*



*Debbie*



*Nick*

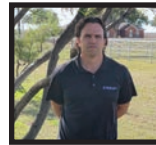

*Travis*



*Kyle*



*Jordan*



*Cody*



*Rebecca*

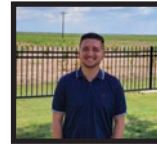

*Marco*

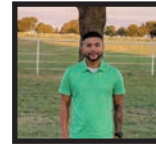

*Jessie*



*Mark*

*We Have Fun  
We Are Helpful  
We Stay Positive  
We Love What We Do  
We Work Hard And Smart  
We Strive For Excellence  
WE ARE A TEAM!*



### Company Information:

Hours of operation: Monday - Friday, 8 a.m. to 5 p.m. CST

Phone: (325) 651-9558 or toll free (866) 651-6702

Fax: (325) 651-9559

Website: [www.springcreekproducts.com](http://www.springcreekproducts.com)

Address: 2152 Schwartz Road, San Angelo, Texas 76904





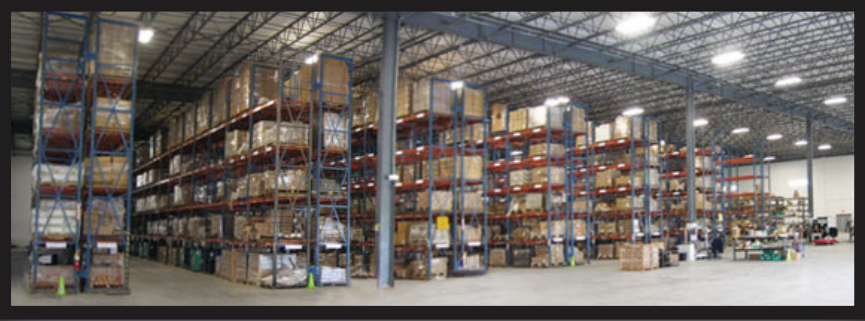
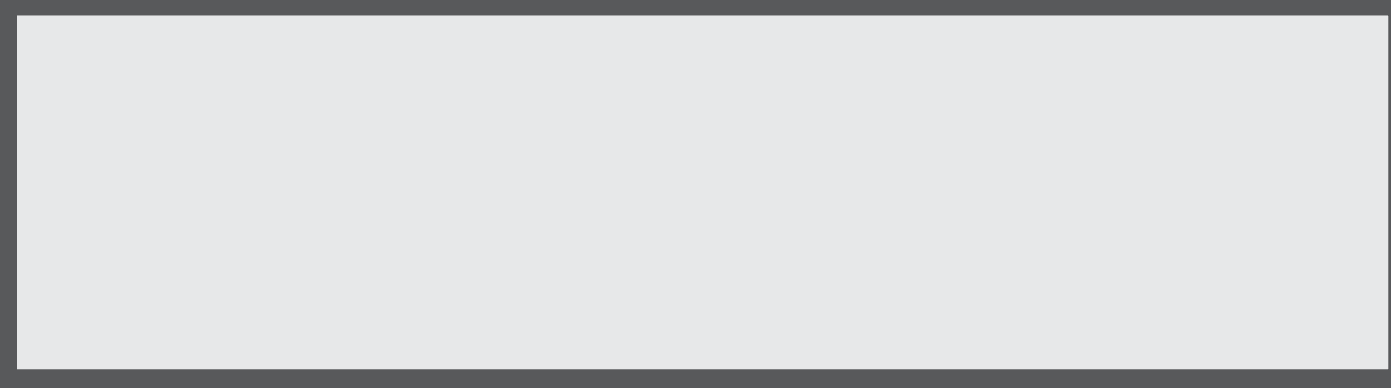

# ***SPRING CREEK<sup>TM</sup> PRODUCTS***

1-866-651-6702 • 325-651-9558

[www.springcreekproducts.com](http://www.springcreekproducts.com)