

**SPRING CREEK™
PRODUCTS**



2023 Catalog

Check Out What's New With



SPRING CREEK™ PRODUCTS

Hardware Products.....1-31

#50305 - Slam Action Latch & Keeper.....	1
#80779 - Heavy-Duty Latch.....	3
#50153 - 10" Round Hinge/3 Piece.....	10
#80984 - Tension Spring 7".....	12
#80986 - Hinge Sleeve 1.315"OD.....	14
#80977 - Pipe Hinge 2-1/16" x 14".....	14
Heavy Pipe Hinge Sleeves.....	14
#80384 - Lockable Hinge Pin.....	21
#80767 - V-Groove Track 9'.....	22
#80908 - Heavy-Duty Door Track 6'.....	23
#80979 - Door Stay Rollers.....	23
#80975 - Spring Handle With Thread.....	25
#81069-81070 - Star Circles Bare.....	26
#46141 - Star Circle Powder Coat.....	26
#46118 - No Hunting Sign.....	26
#46119 - No Trespassing Sign.....	26
#80799 - Cast Iron Brace.....	27
#80656-80677 - Hammered Door Handles.....	28
#80693-80695 - Hammered Push Plates.....	28
#80657 - Hammered Base Mount.....	28
#80666 - Hammered Flat Strap.....	29
#80680 - Hammered "L" Plate.....	29
#80659 - Hammered "T" Plate.....	29
#80654-80673 - Hammered Washers.....	29
#80655-80679 - Hammered Faux Hinges.....	29
#80681 - Hammered Flat Hinge.....	29
#80692 - Hammered Hinge Strap.....	29



Heavy-Duty Latch
(Page 3)



Spring Handle
With Thread
(Page 25)



V-Groove Track
(Page 22)



No Trespassing
Sign
(Page 26)



Hammered Door Pull
(Page 28)



Hammered Faux Hinge
(Page 29)

Trailer Parts.....32-37

#80725 - Hitch Pin 5/8" 3" Bulk.....	32
#80989 - Safety Chain 7/16" x 36" Bulk.....	32
#80981-80983 - Trailer Vents.....	36

Farm and Ranch Products....38-53

#80976 - Horse Stall Channel Galvanized 6'.....	38
#81537 - Horse Stall Channel Bare 6'.....	38
#80974 - Freeze Miser.....	40
#80989 - Target Holder Set.....	40
#81097 - Tie Wire Roll 3.5#.....	43
#80978 - Fence Wire Stretcher.....	43
#81073 - Fence Connector 1.50" x 7-3/8".....	47



Freeze Miser®
(Page 40)



Fence Connector
(Page 47)



Fence Wire Stretcher
(Page 43)

Tools.....80-89

#81046/#81052 - Bora Speedhorse.....	81
RZR Cermet Saw Blades.....	82
Champion Drill Bits XL28.....	86
#80848 - Champion Twister XL28.....	86
#80847 - Champion Tap And Die Kit.....	86
Champion Combination Drill And Tap Bits.....	87
Champion Rotary Hammer Bits.....	87
Champion Hex Step Drill Bits.....	87
#80849 - Champion Step Reamer Set.....	87
Champion Rotary Hammer Bits.....	88
Champion Rotary Rebar Cutters.....	88
Champion Annular Cutters.....	88
Champion Magnetic Drill Presses.....	88



Champion Drill Bits
(Page 86-88)



Bora Sawhorses
(Page 81)

Cut-N-Weld™/Welding.....54-79

#70281-70282 - Welding Helmet Wide Lens.....	54
#70284 - Replacement Headgear.....	54
#70279 - Replacement Lens.....	54
#70283 - Replacement Lens Wide View.....	54
#70280 - Oxy/Acet Hose 1/4" x 50'.....	58
#80373 - Twin Hose 1/4" x 50'.....	58
#70275 - Saddle Series Guide 2-3/8".....	61
#80801 - Roller Head Attachments.....	66
#80802 - Extended V-Head Attachment.....	66
#80980 - Portable Fire Bowl.....	68
#80806-80808 - Fire Pit Bowls.....	68
#81053 - Solid Ball 1".....	69
#80981-80983 - BBQ Vents.....	69
#80809 - Purlin Clip 10ga 5" x 7".....	71
8" Letters/Numbers/Symbols.....	77
3' CTL Threaded Rod.....	78



Welding Helmet
Wide Lens
(Page 54)



Portable Fire Bowl
(Page 68)



8" Letters, Numbers,
And Symbols
(Page 77)

Rigging Products.....90-99

#80725 - Hitch Pin 5/8" x 3" Bulk.....	93
--	----

Shop Gear.....104-106

Mig Welding Gloves.....	105
Stick Welding Gloves.....	105
Tig Welding Gloves.....	105
Drivers Gloves.....	105



Welding Gloves
(Page 105)

Spring Bolt Latches - Aluminum Base

Item #	Style	Size (Length x Width)	Pin	Finish (Base/Pin)	Wt. lbs.	Qty.
#50294	Right	7" x 1-5/8"	3/8"	Bare/SS	0.36 lbs.	100
#50295	Left	7" x 1-5/8"	3/8"	Bare/SS	0.36 lbs.	100



Spring Latch With Rubber Grip - Aluminum Base

Item #	Size (Length x Width x Height)	Pin	Finish (Base/Pin)	Wt. lbs.	Qty.
#50381	7" x 1-1/2" x 1-1/2"	1/2"	Bare/SS	0.55 lbs.	25

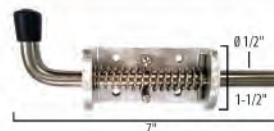

Spring Latch With Welded Tab

Item #	Size (Length x Width)	Pin	Finish	Wt. lbs.	Qty.
#49104	2-5/8" x 1-5/8"	1/2"	Bare	0.27 lbs.	10

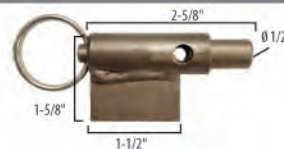

Spring Latches With Weld Plate

Item #	Size (Length x Height)	Pin	Finish (Weld Plate)	Wt. lbs.	Qty.
#50632	4-5/8" x 1-1/2"	5/8"	Bare	0.67 lbs.	20
#47016	6-1/4" x 1-1/2"	5/8"	Bare	0.81 lbs.	20
#50660	6-3/16" x 1-1/2"	5/8"	HDG	0.90 lbs.	20



Spring Horseshoe Latches

Item #	Size (Length x Width)	Pin	Finish	Wt. lbs.	Qty.
#50380	11-1/4" x 3/4"	1/2"	Bare	1.27 lbs.	20
#50383	14-1/2" x 1-1/4"	1"	Bare	3.15 lbs.	10



Spring Latches With Handle

Item #	Type	Size (Length x Width)	Pin	Finish	Wt. lbs.	Qty.
#49836	Square	13-1/4" x 1-1/4"	7/8"	Bare	2.56 lbs.	10
#49837	Round	13-3/8" x 1-3/8"	1"	Bare	2.85 lbs.	10

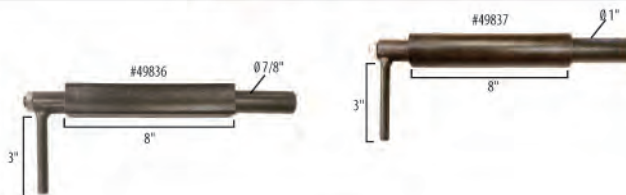

Slam Action Latch And Keeper

Item #	Size (Length x Width)	Pin	Finish	Wt. lbs.	Qty.
<i>New</i> #50305	5-1/2" x 2-1/8"	1"	Stainless Steel	1.17 lbs.	20



Spring Latch With Rubber Grip

Item #	Size (Length x Width x Height)	Pin	Finish	Wt. lbs.	Qty.
#47671	6-5/8" x 2-3/4" x 1-5/16"	1/2"	Zinc	0.74 lbs.	12

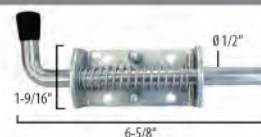

Spring Latches Without Rubber Grip

Item #	Size (Length x Width)	Pin	Finish	Wt. lbs.	Qty.
#50346	5-1/4" x 1-3/4"	1/2"	Zinc	1.00 lbs.	20
#50347	6" x 2"	3/4"	Zinc	2.10 lbs.	20



Spring Latches - Bent Pin

Item #	Style	Size (Length x Width)	Pin	Finish	Wt. lbs.	Qty.
#50348	Left	6-3/4" x 3-3/16"	1/2"	Zinc	0.84 lbs.	45
#50349	Right	6-3/4" x 3-3/16"	1/2"	Zinc	0.84 lbs.	45



Spring Latches With Pull Ring

Item #	Size (Length x Width)	Pin	Finish	Wt. lbs.	Qty.
#46990	11-1/4" x 1"	3/4"	Zinc	1.51 lbs.	10
#49328	11-1/4" x 1-1/4"	1"	Zinc	2.44 lbs.	10

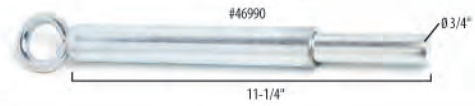

Spring Latch T-Handle

Item #	Size (Length x Width)	Pin	Finish	Wt. lbs.	Qty.
#47339	8-3/4" x 1"	3/4"	Zinc	3.05 lbs.	8



Spring Latches With Round Handle

Item #	Type	Size (Length x Width)	Pin	Finish	Wt. lbs.	Qty.
#49831	Latch	5" x 1"	5/8"	Zinc	0.58 lbs.	100
#50017	Knob	1-3/8"	-	Plastic	0.08 lbs.	50

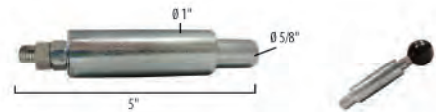

Spring Latches With Tab

Item #	Size (Length x Width)	Pin	Finish	Wt. lbs.	Qty.
#49832	11-1/2" x 4"	1"	Zinc	2.90 lbs.	15
#80192	12-1/2" x 4"	1"	Zinc	2.91 lbs.	15



Spring Latch - Double Barrel

Item #	Size (Length x Width)	Pin	Finish	Wt. lbs.	Qty.
#50287	10-1/16" x 1"	3/4"	Zinc	1.22 lbs.	25

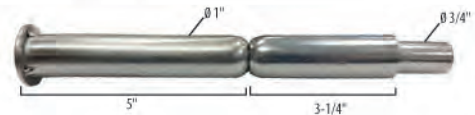

Spring-Loaded Latch With P Handle

Item #	Size (Length x Width x Height)	Pin	Finish	Wt. lbs.	Qty.
#49875	7" x 2-1/8" x 1-1/2"	7/16"	Zinc	0.75 lbs.	20



Square Slam Action Latch

Item #	Size (Length x Width)	Pin	Finish	Wt. lbs.	Qty.
#50304	3-1/4" x 1-1/4"	3/8"	Zinc	0.18 lbs.	20

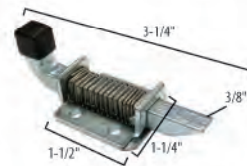

Spring Latches With Key Ring

Item #	Size (Length x Width)	Pin	Finish	Wt. lbs.	Qty.
#47117	2-1/4" x 5/8"	1/2"	Zinc	0.18 lbs.	25
#49835	3" x 7/8"	5/8"	Zinc	0.56 lbs.	25
#50140	Replacement Ring	-	Zinc	0.03 lbs.	500



Square Spring Latch With Chain

Item #	Size (Length x Width)	Pin	Finish	Wt. lbs.	Qty.
#49105	6-1/8" x 2"	1/2"	Zinc	0.50 lbs.	10

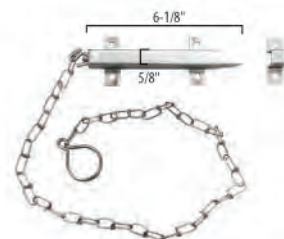

Slam Action Gate Latches

Item #	Style	Size (Length x Width)	Pin	Finish	Wt. lbs.	Qty.
#47685	6" - Right	6-1/2" x 4-5/8"	3/4"	Bare	1.66 lbs.	12
#47686	6" - Left	6-1/2" x 4-5/8"	3/4"	Bare	1.66 lbs.	12
#50118	15" - Right	15-1/2" x 5-3/8"	1"	Bare	4.83 lbs.	4
#50134	15" - Left	15-1/2" x 5-3/8"	1"	Bare	4.83 lbs.	4

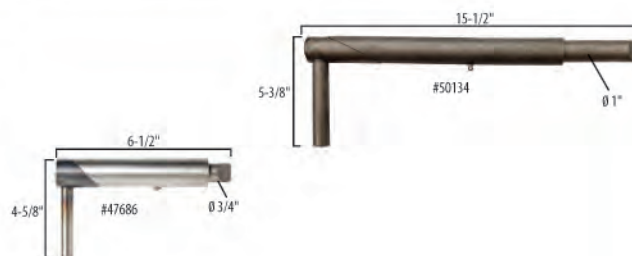

Replacement Parts - For 6" only

Item #	Style	Wt. lbs.	Qty.
#49645	Plunger	0.49 lbs.	1
#49646	Handle	0.24 lbs.	1
#49647	Handle Mount	0.19 lbs.	1
#49649	Spring	0.02 lbs.	1
#49650	Grease Fitting	0.01 lbs.	1

Extra Heavy-Duty Draw Latch

Item #	Size	Finish	Handle	Wt. lbs.	Qty.
<i>New</i> #80779	7"	Powder Coat	Yellow	7.04 lbs.	5



Toggle Clamps

Item #	Size	Finish	Handle	Clamp	Wt. lbs.	Qty.
#48785	5"	Zinc	Red	3/4"	0.51 lbs.	10
#49921	5-1/2"	Stainless Steel	Black	3/4"	0.52 lbs.	10
#48786	7"	Zinc	Red	2-1/8"	1.46 lbs.	10



Stall And Trailer Latches

Item #	Style	Size (Length x Width)	Pin	Finish	Wt. lbs.	Qty.
#50070	4-1/2" - Left	4-1/2" x 5-7/8"	1/2"	Bare	0.88 lbs.	10
#50071	4-1/2" - Right	4-1/2" x 5-7/8"	1/2"	Bare	0.88 lbs.	10
#47017	6" - Left	6" x 6-3/16"	1/2"	Bare	0.69 lbs.	30
#47018	6" - Right	6" x 6-3/16"	1/2"	Bare	0.69 lbs.	30

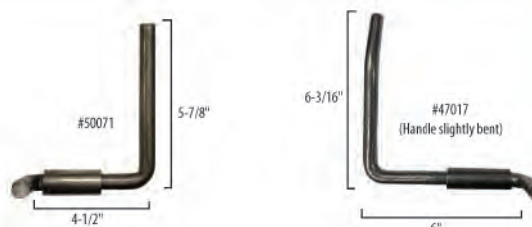

Bar Gate Latches

Item #	Size	Length (Length x Width x Thickness)	Pin	Finish	Wt. lbs.	Qty.
#47619	10"	10-5/8" x 6-1/8" x 1-1/4"	5/8"	Bare	2.57 lbs.	10
#47593	17"	17-1/2" x 6" x 1-1/4"	5/8"	Bare	3.69 lbs.	10
#50149	17"	17-1/2" x 6-1/4" x 1-1/4"	7/8"	Bare	4.71 lbs.	10



1/2" Slide Bolt Lockable Latch

Item #	Size (Length x Width x Height)	Pin	Finish	Wt. lbs.	Qty.
#49364	5-5/8" x 3" x 3"	1/2"	Bare	0.65 lbs.	10



3-5/8" Gate Latch Kit

Item #	Size (Length x Width x Height)	Pin	Finish	Wt. lbs.	Qty.
#50299	3-5/8" x 3-5/8" x 3-1/2"	1/2"	Bare	0.88 lbs.	50



Lockable Bar Gate Latch 12"

Item #	Pin (Length x Diameter)	Plate (Length x Width)	Finish	Wt. lbs.	Qty.
#50553	12-1/2" x 5/8"	6-1/4" x 3"	Bare	1.75 lbs.	10

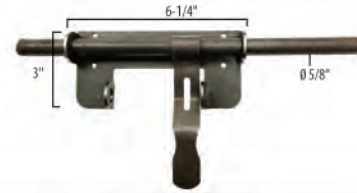

Lockable Bar Gate Latches

Item #	Size	Pin (Length x Diameter)	Plate (Length x Width)	Finish	Wt. lbs.	Qty.
#49370	4"	6" x 1/2"	4" x 3"	Powder Coat	1.05 lbs.	10
#47750	5"	7-7/8" x 5/8"	5" x 3"	Powder Coat	1.48 lbs.	10
#47751	8"	13-1/4" x 3/4"	8" x 3"	Powder Coat	3.00 lbs.	10



Heavy-Duty Double Lockable Bar Gate Latch

Item #	Pin (Length x Diameter)	Plate (Length x Width)	Finish	Wt. lbs.	Qty.
#49683	9-1/2" x 3/4"	6-1/2" x 3-5/8"	Powder	2.35 lbs.	10



Sliding Door Latch

Item #	Size (Length x Width)	Pin	Finish	Wt. lbs.	Qty.
#50462	9-3/4" x 5"	1/2"	Stainless Steel	1.30 lbs.	5

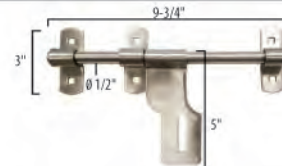

Sliding Lockable Bolt

Item #	Size (Length x Width)	Pin	Finish	Wt. lbs.	Qty.
#49106	6-1/4" x 2-1/4"	3/4"	Stainless Steel	1.04 lbs.	10

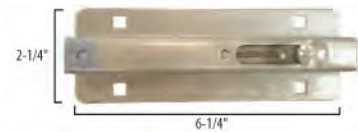

Tower Bolt Door Latch

Item #	Size (Length x Width)	Pin	Finish	Wt. lbs.	Qty.
#50464	6" x 1-3/8"	3/8"	Stainless Steel	0.35 lbs.	25

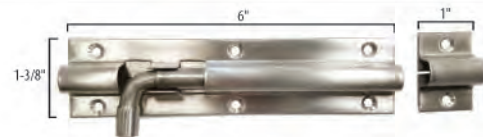

Sliding Locking Latch

Item #	Size (Length x Width)	Pin	Finish	Wt. lbs.	Qty.
#50463	4-1/2" x 2-1/2"	3/8"	Stainless Steel	0.35 lbs.	25



Gate Hook Latch

Item #	Size (Length x Width)	Pin	Finish	Wt. lbs.	Qty.
#50466	6" x 1-1/2"	1/4"	Stainless Steel	0.10 lbs.	25



Barrel Bolt Latches

Item #	Size (Length x Width)	Pin	Finish	Wt. lbs.	Qty.
#49427	3" x 1-5/8"	3/8"	Zinc	0.33 lbs.	10
#50418	6-1/2" x 1-1/2"	3/8"	Zinc	0.54 lbs.	70

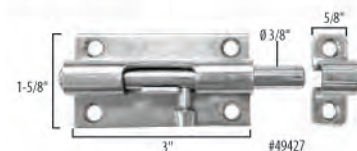

Barrel Bolt Latch - Lockable

Item #	Size (Length x Width)	Pin	Finish	Wt. lbs.	Qty.
#50417	7" x 1-3/4"	3/8"	Zinc	0.74 lbs.	40

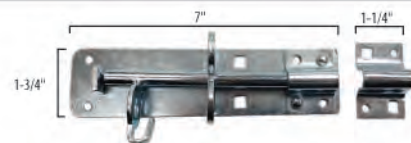

Gate Snap With 30" Chain

Item #	Finish	Wt. lbs.	Qty.
#80440	Zinc	0.39 lbs.	20



Gravity Gate Latches

Item #	Type	Size	Finish	Wt. lbs.	Qty.
#47820	(A) Bolt On	2"	Zinc	0.45 lbs.	1
#48526	(B) Bolt On	2"	Powder	0.45 lbs.	50
#48595	(C) Weld On	2"	Zinc	0.35 lbs.	50
#48631	(D) Bolt On	2"	Zinc	0.48 lbs.	50
#49737	(E) Weld On	1-3/4"	Bare	0.35 lbs.	10



Universal Gate Latch

Item #	Type	Finish	Wt. lbs.	Qty.
#48206	Latch	Powder	1.60 lbs.	20
#48208	Complete Set	Powder	4.89 lbs.	8

*Hinges on page 16, handle on page 25



Wood Post Lockable Gate Latches

Item #	Size (Length x Width x Depth)	Finish	Wt. lbs.	Qty.
#80271	21-1/2" x 6-1/8" x 2"	Powder	5.22 lbs.	5
#80272	21-1/2" x 6-1/8" x 2"	Powder	5.22 lbs.	140 *Bulk Item



Cowboy Latch

Item #	Mounting Plate (Length x Width)	Pin	Finish	Wt. lbs.	Qty.
#50639	26" x 4"	1"	Bare	20.0 lbs.	1

This item does not qualify for free freight.

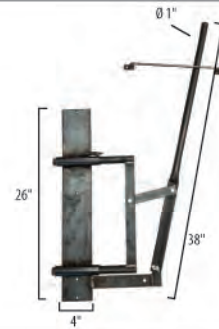

Two-Way Lockable Kennel Latch

Item #	Size (Height x Width x Depth)	Finish	Wt. lbs.	Qty.
#50225	5-1/4" x 2-1/8" x 1-1/4"	Zinc	1.00 lbs.	10



Two-Way Lockable Livestock Gate Latch

Item #	Size (Length x Width x Depth)	Finish	Wt. lbs.	Qty.
#47711	8-7/16" x 4-1/4" x 1-11/16"	Zinc	5.16 lbs.	6



Latch Keepers

Item #	Size (Length x Width x Height)	Pin Opening	Finish	Wt. lbs.	Qty.
#80124	2-1/8" x 3/4" x 5/8"	1/2"	Bare	0.03 lbs.	100
#80125	2-5/8" x 7/8" x 7/8"	5/8"	Bare	0.09 lbs.	100
#49478	2-5/8" x 5/8" x 1"	3/4"	Bare	0.06 lbs.	20
#80126	3" x 1" x 1"	3/4"	Bare	0.13 lbs.	100
#80127	4-1/8" x 1-1/4" x 1-1/8"	1"	Bare	0.24 lbs.	100



Latch Keepers

Item #	Size (Depth x Height X Width)	Pin Opening	Finish	Wt. lbs.	Qty.
#50392	1-1/4" x 1-3/4" x 1-3/4"	1/2"	Zinc	0.20 lbs.	50
#50393	1-3/8" x 2-3/16" x 2-1/8"	3/4"	Zinc	0.35 lbs.	50



Gate Striker Plates

Item #	Size (Length x Width x Depth)	Finish	Wt. lbs.	Qty.
#49829	1-3/4" x 2-1/2" x 2-5/8"	Zinc	0.39 lbs.	50
#47695	2-1/4" x 4-3/8" x 4-1/4"	Bare	1.40 lbs.	20
#47696	2-1/4" x 4-3/8" x 4-1/4"	Zinc	1.40 lbs.	20
#49830	2-1/4" x 4-3/8" x 4"	Bare	1.40 lbs.	20

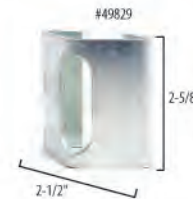

Sign Up To Order Online!

It's simple and easy! Place orders, view product information, prices, and invoices.

Contact your sales representative for more information at 866-651-6702

Check out our website: www.springcreekproducts.com

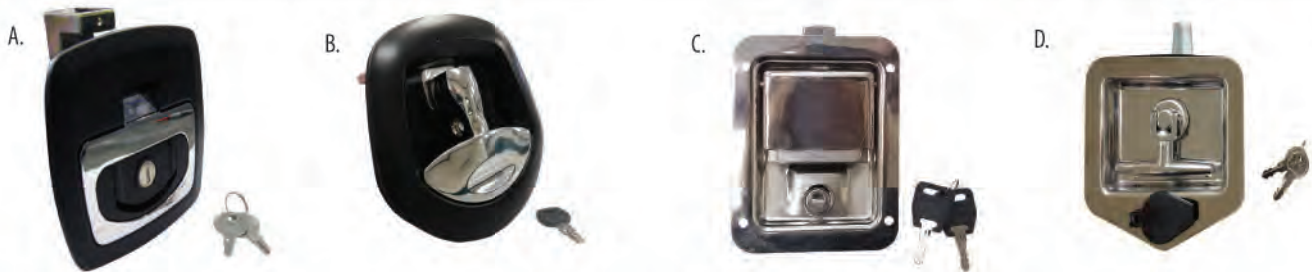

Assorted Lockable Latches

Item #	Type	Latch Style	Plate Size (Width x Height x Depth)	Finish	Wt. lbs.	Qty.
#48145	(A) Compression Latch	Square Press and Pull	3-7/8" x 3-7/8" x 2-5/16"	Plastic	1.20 lbs.	1
#50141	(B) Whale Tail Latch	Whale Tail Lift and Turn	5-1/2" x 5-1/2" x 2-13/16"	Plastic	2.63 lbs.	10
#49429	(C) Slam Action Paddle Handle Latch	Square Studs	4-1/4" x 5-1/2" x 2-5/16"	Stainless Steel	1.01 lbs.	3
#49430	(D) Recessed Folding T-Handle Latch	Whale Tail Lift and Turn	4-3/4" x 4-7/8" x 2-7/8"	Stainless Steel	1.14 lbs.	1

Piano Hinges

Item #	Size (Width x Length)	Thickness	Pin	Finish	Wt. lbs.	Qty.
#80178	2" x 72"	16ga	1/8"	Aluminum	0.85 lbs.	1
#80093	2" x 96"			Aluminum	1.13 lbs.	1
#80096	3" x 72"		3/16"	Aluminum	1.62 lbs.	1
Item #	Size (Width x Length)	Thickness	Pin	Finish	Wt. lbs.	Qty.
#80090	1-1/2" x 72"	16ga	1/8"	Bare	2.00 lbs.	1
#80092	2" x 72"			Bare	2.50 lbs.	1
#80095	3" x 72"		3/16"	Bare	3.00 lbs.	1
#48115	2" x 72"	14ga	1/4"	Bare	4.00 lbs.	1
#48116	2-1/2" x 72"			Bare	4.50 lbs.	1
#48117	3" x 72"			Bare	6.40 lbs.	1
#80097	4" x 72"			Bare	7.00 lbs.	1
#80351	3" x 72"	13ga	3/8"	Bare	6.40 lbs.	1
#49802	3" x 72"	11ga		Bare	11.73 lbs.	1
#49803	4" x 72"			Bare	14.20 lbs.	1
Item #	Size (Width x Length)	Thickness	Pin	Finish	Wt. lbs.	Qty.
#80091	1-1/2" x 72"	16ga	1/8"	Stainless Steel	2.47 lbs.	1
#80094	2" x 72"		3/16"	Stainless Steel	3.56 lbs.	1
#80098	3" x 72"	14ga	1/4"	Stainless Steel	5.00 lbs.	1

These items do not qualify for free freight.



Flat Hinges

Item #	Size (Length x Width)	Thickness	Pin Size	Finish	Wt. lbs.	Qty.
#47052	2" x 2"	13ga	3/16"	Bare	0.13 lbs.	20
#47057	3-1/2" x 2-1/4"	12ga	3/16"	Bare	0.31 lbs.	20
#47053	3" x 3"	12ga	3/16"	Bare	0.33 lbs.	20
#50085	3" x 3"	14ga	3/16"	Bare	0.28 lbs.	20
#47054	3-1/2" x 3-1/2"	13ga	3/16"	Bare	0.38 lbs.	20
#47055	4" x 4"	13ga	3/16"	Bare	0.48 lbs.	40
#47056	3" x 3"	11ga	9/32"	Bare	0.44 lbs.	20
#47058	4" x 4"	7ga	5/16"	Bare	1.04 lbs.	20
#47135	5" x 5"	7ga	5/16"	Bare	1.57 lbs.	20
#47059	6" x 6"	7ga	5/16"	Bare	2.24 lbs.	10



Flat Hinge - Bolt On

Item #	Size (Length x Width)	Thickness	Finish	Wt. lbs.	Qty
#50468	4" x 2-1/4"	16ga	Stainless Steel	0.20 lbs.	25



Parliament Hinge - Bolt On

Item #	Size (Length x Width)	Thickness	Finish	Wt. lbs.	Qty
#50467	4" x 5-7/8"	12ga	Stainless Steel	0.65 lbs.	25

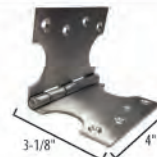

Table Leg Braces (Left and Right)

Item #	Extended Length	Finish	Wt. lbs.	Qty.
#50018	16-3/4"	Stainless Steel	2.99 lbs.	10
#50168	16-3/4"	Zinc	2.99 lbs.	10



Bullet Hinges

Aluminum Body - Stainless Steel Pin And Bushing - With Grease Zerk

Item #	Size	Length	Thickness	Diameter	Pin Size	Wt. lbs.	Qty.
#50200	3-3/16"	3-3/16"	5/8"	1/2"	5/16"	0.08 lbs.	25
#50201	4"	4"	3/4"	5/8"	3/8"	0.18 lbs.	25
#50202	5-3/8"	5-3/8"	7/8"	3/4"	1/2"	0.31 lbs.	25
#80280	6"	6"	1"	7/8"	1/2"	0.38 lbs.	25
#50203	7"	7-1/16"	1"	3/4"	1/2"	0.48 lbs.	25



Aluminum Body - Stainless Steel Pin And Bushing - No Grease Zerk

Item #	Size	Length	Thickness	Diameter	Pin Size	Wt. lbs.	Qty.
#49407	2"	2"	3/8"	5/16"	3/16"	0.02 lbs.	25
#49408	3-3/16"	3-3/16"	5/8"	1/2"	5/16"	0.08 lbs.	25
#49409	4"	4"	3/4"	5/8"	3/8"	0.18 lbs.	25
#49410	5-3/8"	5-3/8"	7/8"	3/8"	1/2"	0.48 lbs.	25
#80281	6"	6"	1"	7/8"	1/2"	0.43 lbs.	25
#49411	7"	7"	7/8"	3/4"	1/2"	0.48 lbs.	25

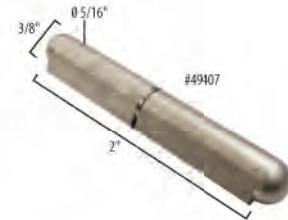

Stainless Steel Body, Pin, And Bushing - No Grease Zerk

Item #	Size	Length	Thickness	Diameter	Pin Size	Wt. lbs.	Qty.
#49413	1-5/8"	1-5/8"	3/8"	5/16"	3/16"	0.03 lbs.	25
#49414	2"	2"	3/8"	5/16"	3/16"	0.04 lbs.	25
#49415	3-3/16"	3-3/16"	5/8"	1/2"	5/16"	0.18 lbs.	25
#49416	4"	4"	3/4"	5/8"	3/8"	0.35 lbs.	25
#49417	5-3/8"	5-3/8"	7/8"	3/4"	1/2"	0.63 lbs.	25
#49418	7"	7"	1"	3/4"	1/2"	1.04 lbs.	25



Steel Body - Brass Pin And Bushing - With Grease Zerk

Item #	Size	Length	Thickness	Diameter	Pin Size	Wt. lbs.	Qty.
#80061	3"	3-1/8"	5/8"	1/2"	5/16"	0.20 lbs.	25
#80062	4"	3-7/8"	3/4"	5/8"	3/8"	0.35 lbs.	25
#80063	4-3/4"	4-3/4"	3/4"	5/8"	3/8"	0.45 lbs.	25
#80064	6"	5-7/8"	1"	3/4"	1/2"	0.75 lbs.	25
#80065	7"	7"	1"	3/4"	1/2"	1.00 lbs.	15

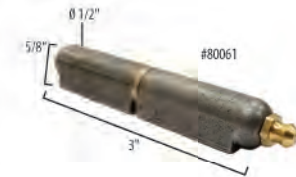

Steel Body - Brass Pin And Bushing - No Grease Zerk

Item #	Size	Length	Thickness	Diameter	Pin Size	Wt. lbs.	Qty.
#48713	2"	2"	3/8"	5/16"	3/16"	0.04 lbs.	25 *
#48217	3-3/16"	3-3/16"	5/8"	1/2"	5/16"	0.19 lbs.	25
#48218	4"	3-15/16"	3/4"	5/8"	3/8"	0.35 lbs.	25 *
#48219	4-3/4"	4-3/4"	3/4"	5/8"	3/8"	0.41 lbs.	25
#49752	6"	5-15/16"	1"	3/4"	1/2"	0.86 lbs.	25
#49167	7"	7"	1"	3/4"	1/2"	1.05 lbs.	25
#49751	8"	7-7/8"	1-1/8"	15/16"	5/8"	1.53 lbs.	20

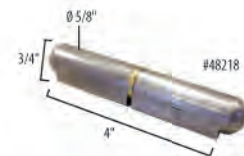

*Sold in pairs on page 67

Steel Body And Pin - Brass Bushing - No Grease Zerk - Lift Off

Item #	Size (Length x Width)	Pin (Length x Diameter)	Wt. lbs.	Qty
#50297	3-1/8" x 7/8"	1-1/8" x 1/4"	0.19 lbs.	20



Bullet Hinges

Steel Body And Pin - Brass Bushing - No Grease Zerk

Item #	Size	Length	Thickness	Diameter	Pin Size	Wt. lbs.	Qty.
#50072	2"	1-15/16"	3/8"	5/16"	3/16"	0.04 lbs.	25
#50073	2-3/4"	2-3/4"	1/2"	7/16"	1/4"	0.12 lbs.	25
#50060	3-5/16"	3-1/8"	5/8"	1/2"	5/16"	0.18 lbs.	25
#50084	4"	3-15/16"	3/4"	5/8"	3/8"	0.35 lbs.	25
#50062	4-3/4"	4-3/4"	3/4"	5/8"	3/8"	0.40 lbs.	25
#50074	6"	5-15/16"	1"	3/4"	1/2"	0.80 lbs.	25
#50075	7"	7-1/16"	1"	3/4"	1/2"	0.97 lbs.	25
#50076	8"	7-7/8"	1-1/7"	7/8"	5/8"	1.44 lbs.	25

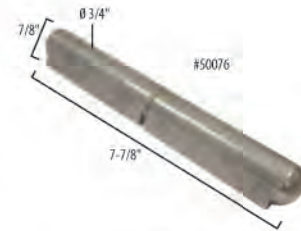

Steel Body And Pin - Brass Bushing - With Grease Zerk

Item #	Size	Length	Thickness	Diameter	Pin Size	Wt. lbs.	Qty.
#48220	3-3/16"	3-3/16"	5/8"	1/2"	5/16"	0.17 lbs.	25 *
#47019	4"	4"	3/4"	5/8"	3/8"	0.36 lbs.	25 *
#48236	4-3/4"	4-3/4"	3/4"	5/8"	3/8"	0.42 lbs.	25 *
#49753	6"	5-15/16"	1"	3/4"	1/2"	0.83 lbs.	25
#47638	7"	7"	1"	3/4"	1/2"	1.01 lbs.	25
#49754	8"	8-3/16"	1-1/8"	15/16"	5/8"	1.46 lbs.	25
#47639	10"	10"	1-1/2"	1-1/16"	3/4"	3.00 lbs.	10



*Sold in pairs on page 67

Zinc Body, Pin, And Brass Bushing - With Grease Zerk

Item #	Size	Length	Thickness	Diameter	Pin Size	Wt. lbs.	Qty.
#80711	7"	7"	1"	3/4"	1/2"	1.01 lbs.	25

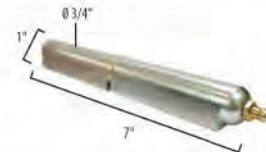

Visit us at
www.springcreekproducts.com

Barrel Hinges

Steel Body And Pin - Brass Bushing - With Grease Zerk

Item #	Size	Length	Diameter	Pin Size	Wt. lbs.	Qty.
#47645	4"	3-15/16"	5/8"	3/8"	0.33 lbs.	20
#47646	6"	5-15/16"	3/4"	1/2"	0.78 lbs.	20
#47647	10"	10-1/4"	1-1/8"	3/4"	2.70 lbs.	8



Steel Body And Pin - No Grease Zerk

Item #	Size	Diameter	Pin Size	Wt. lbs.	Qty.
#47811	2"	5/8"	3/8"	0.16 lbs.	48
#47722	3"	3/4"	1"	0.36 lbs.	25 *

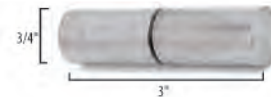

*Sold in pairs on page 67

Zinc Body And Pin - With Grease Zerk

Item #	Size (Length x Width)	Pin Size	Wt. lbs.	Qty.
#47118	4-3/8" x 3/4"	1/2"	0.51 lbs.	20



Barrel Hinges With Sleeve

Item #	Size (Length x Diameter)	Pin Size (Length x Diameter)	Finish	Wt. lbs.	Qty.
#80029	3-15/16" x 3/4"	1-7/8" x 1/2"	Bare	0.45 lbs.	25
#50179	4" x 1"	2" x 3/4"	Bare	0.83 lbs.	25
#50180	4-3/4" x 1"	2-5/8" x 3/4"	Bare	0.91 lbs.	25 *
#50181	5-3/8" x 3/4"	3-1/4" x 1/2"	Bare	0.91 lbs.	25 *

*Includes snap ring feature



Steel Snap Rings

Item #	Diameter	Wt. lbs.	Finish	Fits	Qty.
#50293	3/4"	0.01 lbs.	Bare	4-3/4"	500
#50586	3/4"	0.01 lbs.	Bare	5-3/4"	1,000



10" Round Hinge - Three Piece

Item #	Size (O.D. x Length)	Wt. lbs.	Qty
<i>New</i> #50153	1" x 10-1/8"	2.07 lbs.	10



Three Piece Gate Hinge

Item #	Outer Pipe (O.D. x Length)	Inner Rod (Diameter x Length)	Wt. lbs.	Qty
#50068	1.05" x 3-1/16"	3/4" x 6"	1.33 lbs.	20



Barrel Hinges With Grease Zerks And Weld Plates

Powder Coat

Item #	Size	Length	Width	Height	Weld Plate	Pin Size	Wt. lbs.	Qty.
#49994	4"	4-7/8"	1"	1-3/8"	3/8"	1/2"	1.38 lbs.	10
#47050	5"	5-5/8"	1-1/2"	1-3/16"	1/4"	5/8"	1.44 lbs.	10
#49995	6"	6-3/4"	1-1/2"	1-3/4"	3/8"	7/8"	3.39 lbs.	6
#47051	7"	7-1/4"	1-1/2"	1-7/16"	1/4"	3/4"	2.74 lbs.	6
#80638	9"	9-3/4"	2"	2-3/8"	3/8"	1"	9.62 lbs.	1



Powder Coat Pairs

Item #	Size	Length	Width	Height	Weld Plate	Pin Size	Wt. lbs.	Qty.
#80721	4"	4-7/8"	1"	1-3/8"	3/8"	1/2"	2.81 lbs.	2
#80715	5"	5-5/8"	1-1/2"	1-3/16"	1/4"	5/8"	2.92 lbs.	2
#80722	6"	6-3/4"	1-1/2"	1-3/4"	3/8"	7/8"	7.93 lbs.	2
#80716	7"	7-1/4"	1-1/2"	1-7/16"	1/4"	3/4"	5.61 lbs.	2



Steel Body And Pin, Brass Bushing, With Grease Zerk And Weld Plate

Item #	Size	Length	Width	Diameter	Weld Plate	Pin Size	Wt. lbs.	Qty.
#47640	4"	4-5/16"	3/4"	5/8"	3/16"	3/8"	0.50 lbs.	30
#47641	6"	6-7/16"	1"	3/4"	1/4"	1/2"	1.16 lbs.	20
#47642	10"	10-5/8"	1-1/4"	1-1/8"	3/16"	3/4"	3.58 lbs.	6



Zinc Plated

Item #	Size	Length	Width	Height	Weld Plate	Pin Size	Wt. lbs.	Qty.
#80706	4"	4-7/8"	1"	1-3/8"	3/8"	1/2"	1.36 lbs.	10
#80709	5"	5-5/8"	1-1/2"	1-3/16"	1/4"	5/8"	1.43 lbs.	10
#80708	6"	6-3/4"	1-1/2"	1-3/4"	3/8"	7/8"	3.40 lbs.	6
#80710	7"	7-1/4"	1-1/2"	1-7/16"	1/4"	3/4"	2.76 lbs.	6

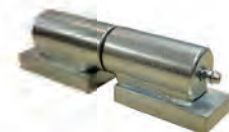

Steel Body Barrel Hinge

Item #	Size (O.D. x Length)	Finish	Wt. lbs.	Qty
#80415	3/4" x 8-3/4"	Bare	1.34 lbs.	20



Square Hinges

Item #	Size	Size (Length x Width x Height)	Pin	Finish	Wt. lbs.	Qty.
#47088	5"	5" x 1-1/4" x 1"	5/8"	Bare	1.64 lbs.	10
#47089	7"	6-3/4" x 1-3/4" x 1-1/4"	3/4"	Bare	3.92 lbs.	6



Item #	Size	Size (Length x Width x Height)	Pin	Finish	Wt. lbs.	Qty.
#80717	5"	5" x 1-1/4" x 1"	5/8"	Bare	3.35 lbs.	2
#80718	7"	6-3/4" x 1-3/4" x 1-1/4"	3/4"	Bare	7.96 lbs.	2

*Pairs

*Pairs



Item #	Size	Size (Length x Width x Height)	Pin	Finish	Wt. lbs.	Qty.
#80705	5"	5" x 1-1/4" x 1"	5/8"	Zinc	1.66 lbs.	10
#80707	7"	6-3/4" x 1-3/4" x 1-1/4"	3/4"	Zinc	3.94 lbs.	6

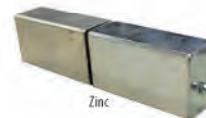

7-3/8" Dump Trailer Hinge With Grease Zerk

Item #	Size (Length x Width)	Plate Thickness	Finish	Wt. lbs.	Qty.
#80251	7-1/2" x 4-1/4"	3/8"	Bare	3.38 lbs.	10



Formed Hinge Straps

Item #	Size (Length x Width)	Leaf Length	Style	Finish	Wt. lbs.	Qty.
#50128	4-1/4" x 2-1/4"	1"	Left	Bare	2.14 lbs.	10
#80770	4-1/4" x 2-1/4"	1"	Right	Bare	2.14 lbs.	10
#50292	6-1/8" x 2-1/4"	3"	Right	Bare	2.55 lbs.	10



4" Flag Double Wrap Hinge

Item #	Size (Length x Width)	Pin	Finish	Wt. lbs.	Qty.
#47676	4" x 2-3/4"	1/2"	Bare	0.69 lbs.	20

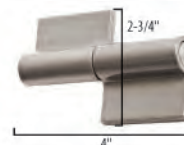

4" Flag Double Wrap Hinge - Bolt On

Item #	Size (Length x Width)	Finish	Wt. lbs.	Qty.
#80236	4" x 2-1/2"	Powder Coat	0.53 lbs.	20



Adjustable Hinge - Bolt On

Item #	Size (Length x Width)	Finish	Wt. lbs.	Qty
#80691	4" x 3-3/8"	Zinc	1.64 lbs.	10



Bat Wing Hinges

Item #	Type	Size (Length x Width x Height)	Pin (Diameter x Length)	Finish	Wt. lbs.	Qty.
#47768	Female	1-1/8" x 1" x 1-1/2"	1/2"	Bare	0.10 lbs.	20
#47769	Male	1" x 1" x 1-1/2"	1/2" x 1"	Bare	0.17 lbs.	10
#47856	Female	1-1/4" x 1-3/16" x 1-5/8"	5/8"	Bare	0.19 lbs.	10
#47857	Male	1-1/4" x 1-3/16" x 1-5/8"	5/8" x 1"	Bare	0.22 lbs.	10
#47869	Female	1-1/4" x 1-1/4" x 1-5/8"	3/4"	Bare	0.13 lbs.	10
#47870	Male	1-1/4" x 1-1/4" x 1-5/8"	3/4" x 1"	Bare	0.27 lbs.	10

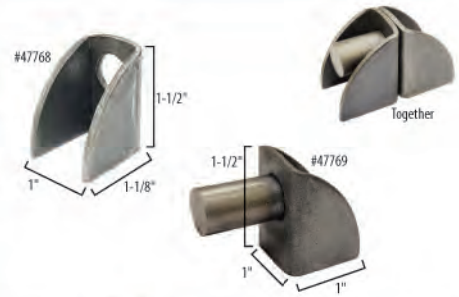

Bat Wing Hinge With Weld Tab

Item #	Weld Tab (Length x Width)	Thickness	Finish	Wt. lbs.	Qty.
#50554	3-7/8" x 1-1/2"	9ga	Bare	0.35 lbs.	10



Winged Hinge

Item #	Size	Size (Length x Width)	Wing Length	Pin	Finish	Wt. lbs.	Qty.
#47643	3-1/2"	3-5/8" x 1-7/8"	1-9/16"	3/4"	Bare	1.06 lbs.	20
#47644	7"	7-1/8" x 1-3/4"	3-3/8"	3/4"	Bare	2.15 lbs.	10



M 18 Swivel Weld On Hinge With Nut

Item #	Size (Welding Surface)	Bolt (Length x Diameter)	Finish	Wt. lbs.	Qty.
#49130	1-3/16" x 1-7/16"	1-5/8" x 5/8"	Zinc	0.65 lbs.	20



360 Degree Weld On Hinge

Item #	Size (Length x Diameter)	Finish	Wt. lbs.	Qty.
#80690	5-1/2" x 3/4"	Zinc	1.24 lbs.	7



*If you need help with an order, have questions about our products,
or have an inquiry about setting up an account,
please contact a member of our team today!*

*We'd love to hear from you!
1-866-651-6702 or sales@springcreekproducts.com*

Tension Spring 7"

Item #	Size (Length x Diameter)	Finish	Wt. lbs.	Qty.
<i>New</i> #80984	7" x 1"	Zinc	0.40 lbs.	25

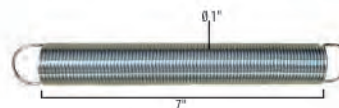

Spring Connector

Item #	Spring Size (Length x Diameter)	Finish	Wt. lbs.	Qty.
#50061	3-3/16" x 1/2"	Zinc	0.09 lbs.	50



Spring Closers

Item #	Size	Finish	Wt. lbs.	Qty.
#49848	9"	Powder Coat	1.15 lbs.	10
#49768	12"	Powder Coat	1.18 lbs.	10



Tear Drop Hinge Plate

Item #	Size (Length x Width)	Hole Size	Thickness	Finish	Wt. lbs.	Qty.
#48072	4" x 1-5/8"	5/8"	3/8"	Bare	0.43 lbs.	66



Tear Drop Hinge With Notch

Item #	Size (Length X Width)	Hole Size	Thickness	Finish	Wt. lbs.	Qty.
#50086	2-1/8" x 1"	3/8"	1/4"	Bare	0.10 lbs.	200
#50087	6-1/16" x 2-3/8"	3/4"	3/8"	Bare	0.90 lbs.	25



\$1,000+ Orders Ship For Free!!!!



**Call your sales representative
today to see if you qualify!**

1-866-651-6702

Some exclusions apply, offer subject to change without notice.

Heavy-Duty Gate Hinges - Gate To Post Mount

Item #	Type	Plate Size (Length x Width x Thickness)	Finish	Wt. lbs.	Qty.
#48371	Standard	7" x 2-7/8" x 1/4"	Powder Coat	3.75 lbs.	2
#80279	Adjustable	7-7/8" x 1-3/4" x 1/4"	Powder Coat	4.52 lbs.	2

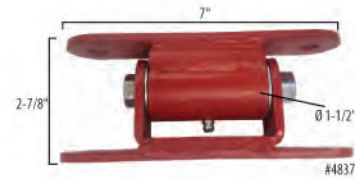

Heavy-Duty Gate Hinges - Flat Mount

Item #	Type	Plate Size (Length x Width x Thickness)	Finish	Wt. lbs.	Qty.
#48372	Standard	5" x 2" x 4ga	Powder Coat	5.48 lbs.	2
#80250	Mini	3-1/2" x 1-1/2" x 4ga	Powder Coat	2.44 lbs.	2
#80277	Adjustable	3-1/2" x 1-3/4" x 1/4"	Powder Coat	2.79 lbs.	2



Heavy-Duty Gate Hinges - Round Mount

Item #	Type	Plate Size (Length x Width)	Finish	Wt. lbs.	Qty.
#48373	Standard	3-3/8" x 1-1/2"	Powder Coat	5.42 lbs.	2
#80278	Adjustable	2-7/8" x 1-1/2"	Powder Coat	2.92 lbs.	2

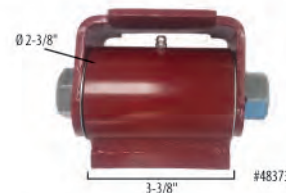

Heavy-Duty Gate Hinge - Flat Mount

Item #	Plate Size (Length x Width x Thickness)	Finish	Wt. lbs.	Qty.
#48374	3-1/2" x 1-1/2" x 4ga	Powder Coat	2.45 lbs.	2



Pipe Hinges - 1 Sleeve / 2 Collars

Item #	Size (Fits over)	O.D. (A)	Sleeve Ht. (B)	Collar Ht. (C)	Finish	Wt. lbs.	Qty.
#49998	1.25" O.D.	1-3/4"	4"	7/16" ea.	Bare	1.60 lbs.	10
<i>New</i> #80986	1.315" O.D.	1-3/4"	3-1/4"	7/16" ea.	Bare	1.07 lbs.	20
#49999	1.66" O.D.	2-1/4"	4"	7/16" ea.	Bare	1.75 lbs.	10
#49654	1.90" O.D.	2-3/8"	3"	1" ea.	Bare	1.90 lbs.	10
#50192	1.90" O.D.	2-3/8"	3"	1" ea.	Zinc	1.90 lbs.	10
#49655	2.375" O.D.	2-7/8"	3"	1" ea.	Bare	2.56 lbs.	10
#49656	2.875" O.D.	3-1/2"	3"	1" ea.	Bare	3.70 lbs.	10
#80195	3.50" O.D.	4"	6"	1" ea.	Bare	5.25 lbs.	4
#80196	4.50" O.D.	5"	8"	1-1/4" ea.	Bare	9.56 lbs.	4



Pipe Hinges - 2 Sleeves / 1 Collar

Item #	Size (Fits over)	O.D. (A)	Sleeve Ht. (B)	Collar Ht. (C)	Finish	Wt. lbs.	Qty.
#80101 #50272	1.66" O.D.	2-1/4"	4"	1/2"	Bare	3.50 lbs.	10 / box 300 / crate
#80102 #50042	1.90" O.D.	2-3/8"	3-1/2"	1"	Bare	3.04 lbs.	10 / box 150 / crate
#80103 #50145	2.375" O.D.	2-7/8"	4"	1"	Bare	4.61 lbs.	10 / box 150 / crate



Pipe Hinges - 1 Sleeve / 1 Collar

Item #	Size (Fits over)	O.D. (A)	Sleeve Ht. (B)	Collar Ht. (C)	Finish	Wt. lbs.	Qty.
#80206	1.25" O.D.	1-3/4"	4"	7/16"	Bare	1.36 lbs.	20
#80015	1.66" O.D.	2-1/4"	4"	1/2"	Bare	2.04 lbs.	20



Pipe Hinges With Threaded Rod

Item #	Size (Fits Over)	Sleeve Height	Thread (Length x Diameter)	Finish	Wt. lbs.	Qty.
#50321	2" O.D.	3"	10-1/2" x 3/4"	Zinc	2.70 lbs.	10
<i>New</i> #80977	2-1/16" OD	2"	10-1/2" x 3/4"	Zinc	2.43 lbs.	10



Heavy Pipe Hinges With Threaded Rod

Item #	Size (Fits Over)	Sleeve Ht.	Collar Ht.	Thread (Length x Diameter)	Finish	Wt. lbs.	Qty.
#80119	1.66" O.D.	4"	1"	14" x 1"	Bare	9.30 lbs.	4
#80121	1.90" O.D.	4"	1"	14" x 1"	Bare	9.60 lbs.	4
<i>New</i> #81047	3-1/2" O.D.	6"	1"	14-3/4" x 1"	Bare	9.75 lbs.	2
<i>New</i> #81048	4-1/2" O.D.	8"	1-1/4"	17-1/4" x 1"	Bare	14.48 lbs.	2

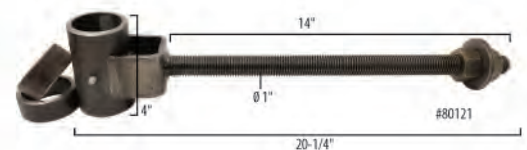

*Looking for more gate accessories?
See the Farm and Ranch
section on page 40 and 42.*





Rectangular Hinge Adapter

Item #	Size (Length x Width x Height)	Thickness	Finish	Wt. lbs.	Qty.
#80424	2" x 3" x 2-1/2"	3/16"	Bare	1.10 lbs.	36



Round Mount to
Square Mount



Round Mount to
Round Mount

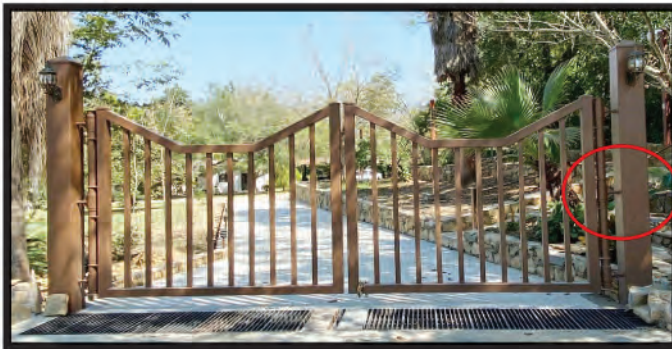

Ring Adapter for Pipe



Ring Adapters For Pipe

Item #	Holds (Fits Over)	Size (Height x Width)	Thickness	Finish	Wt. lbs.	Qty.
#80425	1.25" OD	2-1/2" x 1-3/4"	3/8"	Bare	0.29 lbs.	20
#80427	1.66" OD	3" x 2-1/4"	3/8"	Bare	0.43 lbs.	20
#80429	1.90" OD	3-1/16" x 2-3/8"	3/8"	Bare	0.39 lbs.	20
#80431	2.375" OD	3-5/8" x 2-7/8"	3/8"	Bare	0.52 lbs.	20
#80433	2.875" OD	4-1/4" x 3-7/16"	3/8"	Bare	0.68 lbs.	20
#80435	3.50" OD	4-11/16" x 4"	3/8"	Bare	0.74 lbs.	20
#80437	4.50" OD	5-3/4" x 5"	3/8"	Bare	1.04 lbs.	20



Ring Adapters For Hinge Sleeves

Item #	Holds (Fits Over)	Size (Height x Width)	Hinge Sleeve Reference	Thickness	Finish	Wt. lbs.	Qty.
#80426	1.765" OD	2-3/4" x 2-1/4"	1.25" OD	3/8"	Bare	0.36 lbs.	20
#80428	2.25" OD	3-3/8" x 2-7/8"	1.66" OD	3/8"	Bare	0.47 lbs.	20
#80430	2.36" OD	3-3/8" x 2-7/8"	1.90" OD	3/8"	Bare	0.43 lbs.	20
#80432	2.875" OD	3-7/8" x 3-3/8"	2.375" OD	3/8"	Bare	0.54 lbs.	20
#80434	3.438" OD	4-11/16" x 4"	2.875" OD	3/8"	Bare	0.73 lbs.	20
#80436	3.967" OD	4-15/16" x 4-7/16"	3.50" OD	3/8"	Bare	0.77 lbs.	20
#80438	5.00" OD	6" x 5-1/2"	4.50" OD	3/8"	Bare	1.02 lbs.	20



Strap Hinge

Item #	Size (Length x Width)	Finish	Wt. lbs.	Qty.
#50157	10" x 4-1/2"	HDG	1.65 lbs.	10

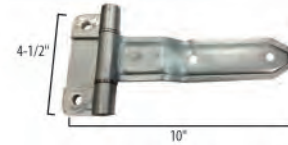

Universal Strap Hinge 8"

Item #	Type	Finish	Wt. lbs.	Qty.
#48207	Hinge	Powder Coat	1.51 lbs.	10
#48208	Complete Set	Powder Coat	5.87 lbs.	8



*Latches on page 5, handle on page 25

Strap Hinges - Stainless Steel

Item #	Type	Size (Length x Width)	Finish	Wt. lbs.	Qty.
#50154	(A) Weld On	6-1/8" x 2-5/8"	SS	0.59 lbs.	10
#50155	(B) Round-Bolt On	6-1/8" x 2-5/8"	SS	0.57 lbs.	10
#50156	(C) Square-Bolt On	6-1/8" x 2-5/8"	SS	0.58 lbs.	10

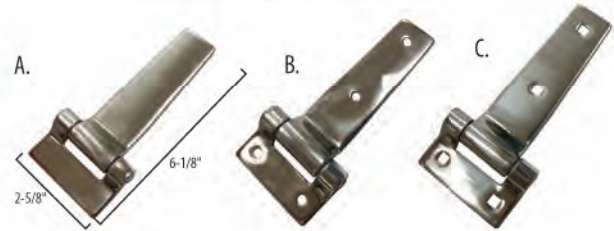

Strap Hinges With Grease Zerk

Item #	Size (Length x Width)	Thickness	Finish	Wt. lbs.	Qty.
#49460	5-3/4" x 2-1/2"	9ga	Zinc	0.66 lbs.	10
#49461	7-3/8" x 2-1/2"	9ga	Zinc	0.78 lbs.	25

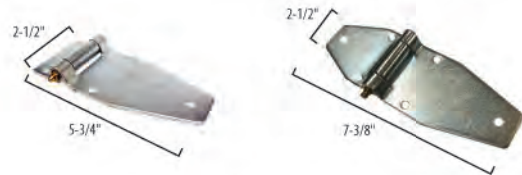

Strap Hinges

Item #	Size	Length x Height	Finish	Wt. lbs.	Qty
#50308	4-1/4"	8" x 1-3/4"	Zinc	0.27 lbs.	100
#50309	5"-3/16"	10" x 2"	Zinc	0.36 lbs.	100
#50310	6-1/8"	11-1/2" x 2-1/2"	Zinc	0.53 lbs.	10



Strap Hinges With Triangle Base

Item #	Size	Length x Height	Finish	Wt. lbs.	Qty
#50311	8"	11" x 4-1/2"	Zinc	1.92 lbs.	10
#50312	12"	15" x 4-1/2"	Zinc	2.29 lbs.	10
#50313	16"	19" x 4-1/2"	Zinc	2.61 lbs.	10

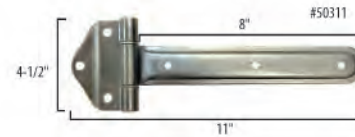

Embossed Strap Hinges

Item #	Size	Length x Height	Finish	Wt. lbs.	Qty.
#50066	10-1/4"	10-1/4" x 4-1/2"	Zinc	1.15 lbs.	10
#50065	17-3/4"	17-3/4" x 4-1/2"	Zinc	2.42 lbs.	10



Heavy-Duty Tee Hinge

Item #	Size (Length x Width)	Finish	Wt. lbs.	Qty.
#50424	12-1/2" x 7"	Zinc	2.20 lbs.	20



Hasp And Staple

Item #	Staple (Length x Width)	Hasp (Length x Width)	Finish	Wt. lbs.	Qty
#50465	1-1/2" x 1-1/2"	4-3/8" x 1-3/8"	SS	0.20 lbs.	25



Hasp And Staple Hinge Strap

Item #	Staple (Length x Width)	Hasp (Length x Width)	Finish	Wt. lbs.	Qty
#50298	1-7/8" x 2"	9-3/4" x 3/4"	Zinc	1.18 lbs.	50



Hasp And Staple Hinge Strap

Item #	Staple (Length x Width)	Hasp (Length x Width)	Finish	Wt. lbs.	Qty
#50314	1-5/8" x 1-3/16"	6-1/4" x 1-1/2"	Zinc	0.27 lbs.	20



Heavy-Duty Hasp And Staple

Item #	Staple (Length x Width)	Hasp (Length x Width)	Finish	Wt. lbs.	Qty
#50423	2-1/8" x 2-1/2"	8-3/4" x 2-1/8"	Zinc	1.21 lbs.	30



Hasp And Staple With Swivel Lock

Item #	Staple (Length x Width)	Hasp (Length x Width)	Finish	Wt. lbs.	Qty
#50316	2" x 2"	8" x 2"	Zinc	0.67 lbs.	20



Adjustable Square Hinges

Item #	Size	Size (Length x Width x Height)	Diameter	Finish	Wt. lbs.	Qty.
#80033	7"	5-1/2" x 1-1/4" x 9-3/8"	7/8"	Bare	4.95 lbs.	2
#80714	7"	5-1/2" x 1-1/4" x 9-3/8"	7/8"	Zinc	4.86 lbs.	2

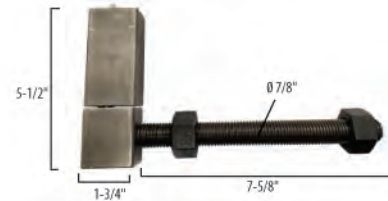

Adjustable Square Hinge - With J-bolt

Item #	Size	Size (Length x Width x Height)	Diameter	Finish	Wt. lbs.	Qty.
#80032	4"	5-3/8" x 3-5/8" x 1"	5/8"	Zinc	2.75 lbs.	2

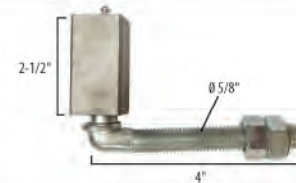

J-Bolt Adjustable Barrel Hinges

Powder Coat

Item #	Diameter	Length	Height	Plate Size (Length x Width)	Wt. lbs.	Qty.
#48036	5/8"	5-5/16"	3-3/4"	2-1/8" x 1"	1.30 lbs.	20
#48037	3/4"	10"	4-3/4"	2-7/8" x 1-1/2"	3.00 lbs.	8



Powder Coat Pairs

Item #	Diameter	Length	Height	Plate Size (Length x Width)	Wt. lbs.	Qty.
#80719	5/8"	5-5/16"	3-3/4"	2-1/8" x 1"	2.69 lbs.	2
#80720	3/4"	10"	4-3/4"	2-7/8" x 1-1/2"	6.36 lbs.	2



Zinc Plated

Item #	Diameter	Length	Height	Plate Size (Length x Width)	Wt. lbs.	Qty.
#80712	5/8"	5-5/16"	3-3/4"	2-1/8" x 1"	1.29 lbs.	20
#80713	3/4"	10"	4-3/4"	2-7/8" x 1-1/2"	3.10 lbs.	8



J-Bolts With Washers And Nuts

Bare

Item #	Size (Diameter x Length)	Width	Length	Pintle	Wt. lbs.	Qty.
#49346	5/8" x 6"	5/8"	6"	1-1/2"	0.87 lbs.	40
#49347	5/8" x 12"	5/8"	12"	1-1/2"	1.33 lbs.	20
#49352	3/4" x 12"	3/4"	12"	2"	2.02 lbs.	20
#49353	3/4" x 18"	3/4"	18"	2"	2.59 lbs.	10
#49457	7/8" x 12"	7/8"	12"	3"	3.00 lbs.	10

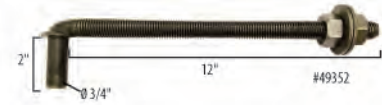

Hot Dipped Galvanized

Item #	Size (Diameter x Length)	Width	Length	Pintle	Wt. lbs.	Qty.
#49501	1/2" x 4-1/2"	1/2"	4-1/2"	1-1/2"	0.70 lbs.	20
#47940	5/8" x 4-1/2"	5/8"	4-1/2"	1-1/2"	0.81 lbs.	20
#49345	5/8" x 6"	5/8"	6"	1-1/2"	0.90 lbs.	40
#49348	5/8" x 12"	5/8"	12"	1-1/2"	1.31 lbs.	20
#47943	5/8" x 18"	5/8"	18"	1-1/2"	1.72 lbs.	10
#49351	3/4" x 12"	3/4"	12"	2"	1.69 lbs.	20
#47939	3/4" x 18"	3/4"	18"	2"	2.51 lbs.	10



Zinc Plated

Item #	Size (Diameter x Length)	Width	Length	Pintle	Wt. lbs.	Qty.
#49458	1/2" x 4-1/2"	1/2"	4-1/2"	1-1/2"	0.53 lbs.	20
#47941	5/8" x 6"	5/8"	6"	1-1/2"	0.87 lbs.	20
#47942	5/8" x 12"	5/8"	12"	1-1/2"	1.00 lbs.	20
#80051	5/8" x 12"	5/8"	12"	1-1/2"	1.00 lbs.	20
#47584	3/4" x 12"	3/4"	12"	2"	2.05 lbs.	20
#49354	3/4" x 18"	3/4"	18"	2"	2.51 lbs.	10



*Washers and nuts not included

Lag Hinge Pins

Bare

Item #	Size (Diameter x Length)	Length	Pintle	Diameter	Wt. lbs.	Qty.
#49357	5/8" x 6"	6"	1-1/2"	5/8"	0.55 lbs.	20
#47586	3/4" x 6"	6"	2"	3/4"	1.00 lbs.	20



Hot Dipped Galvanized

Item #	Size (Diameter x Length)	Length	Pintle	Diameter	Wt. lbs.	Qty.
#49358	5/8" x 6"	6"	1-1/2"	5/8"	0.57 lbs.	20
#49360	3/4" x 6"	6"	2"	3/4"	1.00 lbs.	20

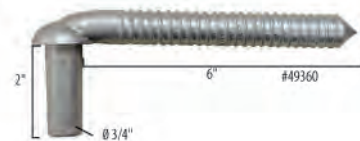

Zinc Plated

Item #	Size (Diameter x Length)	Length	Pintle	Diameter	Wt. lbs.	Qty.
#48660	5/8" x 6"	6"	1-1/2"	5/8"	0.55 lbs.	20
#49970	5/8" x 6"	6"	2"	5/8"	0.59 lbs.	100
#47585	3/4" x 6"	6"	2"	3/4"	1.03 lbs.	20
#80073	3/4" x 8"	8"	2"	3/4"	1.30 lbs.	20

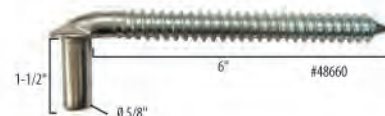

Round Male Hinges - Bolt On

Item #	Size (Pintle Diameter x Pipe OD)	Finish	Wt. lbs.	Qty.
#80151	5/8" x 1-3/8"	HDG	0.44 lbs.	10
#50344	5/8" x 1-3/8"	Zinc	0.60 lbs.	25
#50264	5/8" x 1-3/4"	Zinc	0.60 lbs.	50
#49924	5/8" x 2-3/8"	HDG	0.66 lbs.	10
#49925	5/8" x 2-7/8"	HDG	0.77 lbs.	10



Round Female Hinge - Bolt On

Item #	Size (Pintle Insert x Pipe OD)	Finish	Wt. lbs.	Qty.
#49978	3/4" x 2"	HDG	0.75 lbs.	25



Round Female Hinges - Bolt On

Item #	Size (Pintle Insert x Pipe OD)	Finish	Wt. lbs.	Qty.
#49977	3/4" x 1-1/2"	HDG	0.75 lbs.	25
#80349	3/4" x 2"	Zinc	0.75 lbs.	25
#80153	5/8" x 1-3/8"	HDG	0.28 lbs.	25
#49976	5/8" x 1-3/4"	Zinc	0.33 lbs.	25

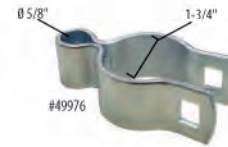

Round Female Hinges - Bolt On

Item #	Size (Pintle Insert x Pipe OD)	Finish	Wt. lbs.	Qty.
#49020	5/8" x 1-5/8"	HDG	0.55 lbs.	25
#49021	5/8" x 1-7/8"	HDG	0.55 lbs.	25
#48803	3/4" x 1-3/4"	Zinc	0.75 lbs.	25
#48804	3/4" x 2"	Zinc	0.90 lbs.	25



Square Female Hinges - Bolt On

Item #	Size (Pintle Insert x Tube Size)	Finish	Wt. lbs.	Qty.
#50267	5/8" x 1-1/2"	Zinc	0.71 lbs.	25
#50261	3/4" x 1-1/2"	Zinc	0.92 lbs.	50
#50265	3/4" x 2"	Zinc	0.65 lbs.	25



Female Hinge Straps - Weld On

Item #	Size (Pintle Insert x Pipe Open)	Finish	Depth	Wt. lbs.	Qty.
#49022	5/8" x 1-5/8"	HDG	1-1/2"	0.39 lbs.	25
#49986	5/8" x 1-3/4"	Zinc	1-1/2"	0.43 lbs.	50
#49023	5/8" x 1-7/8"	HDG	1-1/2"	0.40 lbs.	25
#48806	3/4" x 2"	HDG	2"	0.45 lbs.	25
#49987	3/4" x 2"	Zinc	1-1/2"	0.51 lbs.	25
#80636	3/4" x 2"	Bare	1-1/2"	0.52 lbs.	25



Female Hinges With Weld On Plate

Item #	Size (Pintle Insert)	Plate Size (Length x Width)	Finish	Wt. lbs.	Qty.
#49682	5/8"	2" x 1-1/2"	Bare	0.30 lbs.	50
#49681	3/4"	2" x 1-1/2"	Bare	0.41 lbs.	50

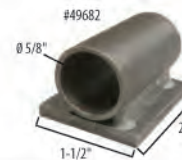

Carriage Bolts

Item #	Size (Length x Diameter)	Finish	Wt. lbs.	Qty.
#50530	2-1/2" x 3/8"	Zinc	0.20 lbs.	25
#50531	3-1/2" x 3/8"	Zinc	0.24 lbs.	25

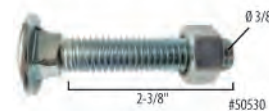

HARDWARE PANEL ACCESSORIES

Panel Clamps

Item #	Size	Hardware	Finish	Wt. lbs.	Qty.
#80402	1-5/8"	Yes	Bare	0.91 lbs.	50
#48988	1-5/8"	Yes	HDG	0.91 lbs.	50
#48989	1-7/8"	Yes	HDG	0.97 lbs.	50

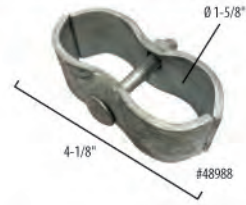

Saddle Panel Clamps

Item #	Size	Hardware	Finish	Wt. lbs.	Qty.
#50010	1-5/8"	Yes	Zinc	0.73 lbs.	25
#80155	1-3/8"	No	HDG	0.26 lbs.	25

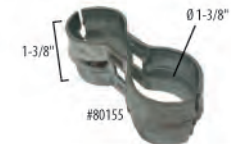
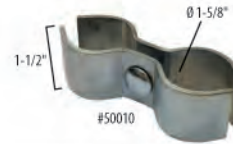

Panel Adapters

Item #	Size	Finish	Wt. lbs.	Qty.
#48990	2-3/8" x 1-5/8"	HDG	1.08 lbs.	20
#49796	2-3/8" x 1-7/8"	HDG	1.08 lbs.	20



Gate Collar

Item #	Size	Finish	Wt. lbs.	Qty.
#80156	1-3/8"	HDG	0.37 lbs.	25



Gate Fork With Handle

Item #	Size (Length x Height)	Finish	Wt. lbs.	Qty.
#80154	4-1/4" x 1-1/2"	HDG	0.33 lbs.	25

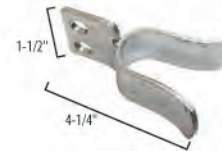

Chain Link Fence Accessories

Male and Female Hinges



Gate Collar



Gate Fork



Saddle Clamp



Corral Pins

Item #	Style	Size (Length x Diameter)	Finish	Wt. lbs.	Qty.
#49870	Pin	4" x 3/4"	Zinc	0.16 lbs.	200
#49869	V-Pin	10-1/8" x 7/16"	Zinc	0.43 lbs.	100

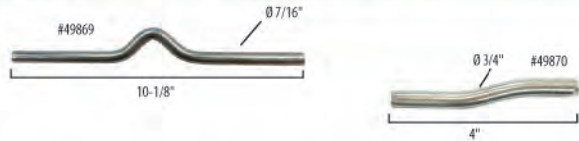

Lockable Pins

New

Item #	Type	Size (Length x Height)	Finish	Wt. lbs.	Qty.
#80384	Straight	5-7/8" x 2-1/2"	Powder Coat	0.43 lbs.	50
#80805	Bent	5-1/2" x 4-7/8"	Powder Coat	0.41 lbs.	50

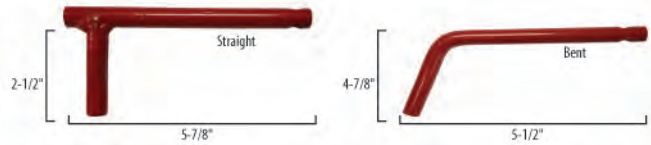

Cane Drop Pin 8"

Item #	Size (Length x Height)	Finish	Wt. lbs.	Qty.
#50007	8-3/4" x 2-1/4"	Zinc	0.90 lbs.	25



"P" Drop Pin 11"

Item #	Size (Length x Height)	Finish	Wt. lbs.	Qty.
#50135	11-1/4" x 2-5/8"	Zinc	1.09 lbs.	50



Corral Drop Pin And Bracket

Item #	Type	Size (Length x Height)	Finish	Wt. lbs.	Qty.
#48658	Drop Pin	9" x 1/2"	Zinc	0.73 lbs.	50
#48657	Bracket	3-3/4" x 1"	Zinc	0.28 lbs.	150

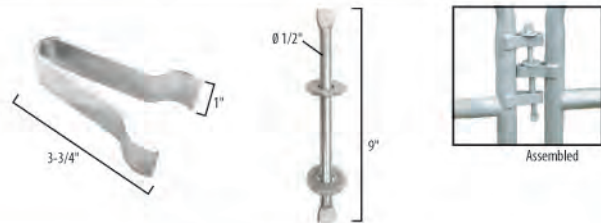

NEW ARRIVALS

Shop Now

See the newest additions on our website,
www.springcreekproducts.com

Hinge Straps

Item #	Size (Depth x Height)	Thickness	Finish	Wt. lbs.	Qty.
#49975	1-1/2" x 1-1/2"	9ga	Zinc	0.21 lbs.	150
#50635	1-7/8" x 1"	11ga	Bare	0.13 lbs.	100
#49750	1-7/8" x 2-1/4"	11ga	Bare	0.29 lbs.	100



Three-Way Bracket

Item #	Size (Depth x Height)	Thickness	Finish	Wt. lbs.	Qty.
#49972	1-1/2" x 1-9/16"	9ga	Zinc	0.61 lbs.	50



HARDWARE WHEELS AND ROLLERS

Covered Rubber Guide Rollers

Item #	Size (Length x Width x Height)	Finish	Wt. lbs.	Qty.
#50204	3-3/8" x 3" x 2-1/2"	HDG	2.00 lbs.	10
#50205	6-1/8" x 3" x 2-5/8"	HDG	3.40 lbs.	10

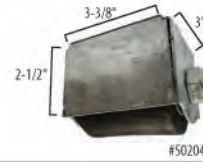

Rubber Guide Rollers - No Mark

Item #	Size (Length x Width x Height)	Finish	Wt. lbs.	Qty.
#80474	3" x 2-1/4" x 2-7/16"	Bare	1.22 lbs.	40
#80475	8" x 2-5/16" x 2-7/8"	Bare	1.96 lbs.	20



Rubber Guide Rollers

Item #	Size (Length x Width x Height)	Finish	Wt. lbs.	Qty.
#47821	3-3/8" x 2-1/2" x 3"	Bare	1.26 lbs.	20
#47822	6-1/2" x 2-1/2" x 3"	Bare	2.29 lbs.	10
#49114	11-3/4" x 2-3/8" x 2-5/8"	Bare	4.39 lbs.	12

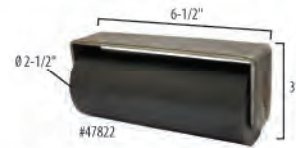

V-Groove Wheels - Cast Iron

Item #	Wheel Size (Diameter x Width)	Working Load Limit (Maximum)	Fits Box	Finish	Wt. lbs.	Qty.
#80227	3" x 1-1/2"	300 lbs.	#80228	Bare	1.69 lbs.	12
#47061	4" x 1-1/2"	600 lbs.	#48411 #80228	Bare	2.89 lbs.	8
#47062	6" x 2"	800 lbs.	#K0002	Bare	5.59 lbs.	2



Premium V-Groove Wheels - Steel

Item #	Wheel Size (Diameter x Width)	Fits Box	Finish	Wt. lbs.	Qty.
#49709	4" x 1-7/8"	#48411 #50342	Bare	5.36 lbs.	8
#49844	6" x 1-3/4"	#50209	Bare	12.30 lbs.	2



V-Groove Wheel Track

Item #	Size (Length x Width)	Finish	Wt. lbs.	Qty.
<i>New</i> #80767	9'10" x 3-5/8"	Zinc	13.30 lbs.	1

This item does not qualify for free freight.



V-Groove Wheel Boxes

Bare

Item #	Size	Box Size (Length x Width x Depth)	Fits Wheel	Wt. lbs.	Qty.
#80228	3" & 4"	5" x 2-1/4" x 3-1/8"	#80227, #47061, #49709	1.53 lbs.	8



Hot Dipped Galvanized

Item #	Size	Box Size (Length x Width x Depth)	Fits Wheel	Wt. lbs.	Qty.
#80698	3" & 4"	5" x 2-1/4" x 3-1/8"	#47061, 49709	1.41 lbs.	8
#80699	6"	7" x 2-7/8" x 4"	#47062	2.88 lbs.	2



Powder Coat

Item #	Size	Box Size (Length x Width x Depth)	Fits Wheel	Wt. lbs.	Qty.
#48411	4"	5" x 2-5/16" x 3-1/8"	#47061, #49709	1.76 lbs.	8
#K0002	6"	7" x 2-7/8" x 4"	#47062	2.88 lbs.	2
#50209	6"	7" x 2-5/16" x 4-1/8"	#49844	2.85 lbs.	2



Door Track Brackets

Item #	Track Type	Size (Height x Width x Depth)	Finish	Wt. lbs.	Qty.
#47854	(A) Single Splice	4-1/2" x 2" x 2"	HDG	0.71 lbs.	25
#48038	(B) Single Mount	4-1/2" x 2" x 2-1/8"	HDG	0.72 lbs.	25
#48080	(C) Single Ceiling	3-5/8" x 4-7/8" x 1-3/4"	HDG	1.13 lbs.	10
#48081	(D) Single Wall	7-3/16" x 3-3/8" x 1-3/4"	HDG	1.22 lbs.	10
#48082	(E) Double Wall	8-11/16" x 4-7/16" x 1-3/4"	HDG	2.04 lbs.	10

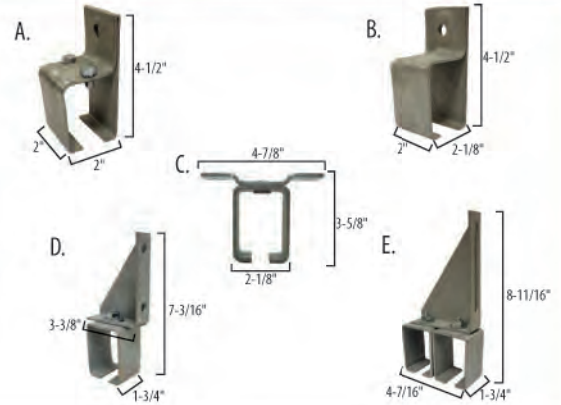

Premium 4 Wheel Door Track Roller

Item #	Wt. Capacity	Finish	Wt. lbs.	Qty.
#47902	1,430 lbs.	Painted	1.06 lbs.	2

Works with most popular name brand door tracks.



Heavy-Duty Galvanized Door Tracks

New

Item #	Size	Thickness	Finish	Wt. lbs.	Qty.
#80908	6'	14ga	Zinc	11.88 lbs.	1
#49173	8'	14ga	Zinc	15.84 lbs.	1
#49174	10'	14ga	Zinc	19.80 lbs.	1
#49175	12'	14ga	Zinc	23.76 lbs.	1

These items do not qualify for free freight.



Door Stay Roller

New

Item #	Finish	Wt. lbs.	Qty.
#80979	Zinc	1.26 lbs.	20

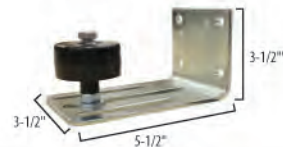

Cast Iron BBQ Wheels And Mounting Kit

Item #	Wheel Size (Diameter x Width)	Finish	Wt. lbs.	Qty.
#49503	4" x 1-1/4"	Bare	1.38 lbs.	10
#49504	5" x 1-1/4"	Bare	1.79 lbs.	10
#50400	Kit	Bare	1.05 lbs.	10 (Wheel Not Included)



10" Semi Pneumatic Wheel

Item #	Wt. lbs.	Qty.
#80394	5.09 lbs.	1



8" Gate Wheel

Item #	Finish	Wt. lbs.	Qty.
#50636	Zinc	3.85 lbs.	6



HARDWARE WHEELS AND ROLLERS

11" Gate Spring Roller

Item #	Wt. Capacity	Finish	Wt. lbs.	Qty.
#50670	400 lbs.	Bare	4.85 lbs.	6

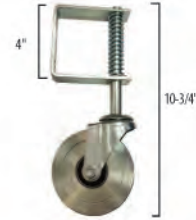

16" Gate Spring Roller

Item #	Wt. Capacity	Finish	Wt. lbs.	Qty.
#47823	100 lbs.	Bare	3.11 lbs.	10



Tall Gate Wheel

Item #	Finish	Wt. lbs.	Qty.
#80276	Powder Coat	10.60 lbs.	3



Plastic Wheel Casters

Item #	Style	Wheel Size (Diameter x Width)	Plate Size (Length x Width)	Finish	Wt. lbs.	Qty.
#50063	Rigid	5" x 1-1/2"	4-1/2" x 3-3/4"	Zinc	2.21 lbs.	16
#50064	Swivel	5" x 1-1/2"	4-1/2" x 3-3/4"	Zinc	2.41 lbs.	16



Rubber Wheel Casters - Swivel

Item #	Style	Wheel Size (Diameter x Width)	Plate Size (Length x Width)	Finish	Wt. lbs.	Qty.
#48628	Standard	3" x 1-1/4"	4" x 3-1/8"	Zinc	1.24 lbs.	12
#48629	Standard	4" x 1-1/4"	3-3/4" x 2-5/8"	Zinc	2.06 lbs.	12
#50091	Heavy-Duty	4" x 2"	4-1/2" x 4"	Zinc	4.00 lbs.	8



Rubber Wheel Casters - Rigid

Item #	Wheel Size (Diameter x Width)	Plate Size (Length x Width)	Finish	Wt. lbs.	Qty.
#48627	3" x 1-1/4"	4" x 2-3/8"	Zinc	0.96 lbs.	12
#48630	4" x 1-3/16"	3-3/4" x 2-5/8"	Zinc	1.56 lbs.	12

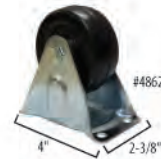

Rubber Wheel Casters - Locking Swivel

Item #	Style	Wheel Size (Diameter x Width)	Plate Size (Length x Width)	Finish	Wt. lbs.	Qty.
#80086	Standard	3" x 1-1/4"	4" x 3-1/8"	Zinc	1.26 lbs.	12
#50092	Heavy-Duty	4" x 2"	4-1/2" x 4"	Zinc	4.31 lbs.	8
#49730	Standard	4-7/8" x 1-1/4"	3-3/4" x 2-5/8"	Zinc	2.34 lbs.	10

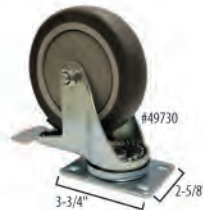

Chest Handle With Rubber Grip

Item #	Size	Plate Size (Length x Width)	Finish	Wt. lbs.	Qty.
#50302	4"	3-3/8" x 1-7/8"	Zinc	0.35 lbs.	100



Recessed Handle

Item #	Plate Size (Length x Width)	Finish	Wt. lbs.	Qty.
#50300	6-3/8" x 4-1/4"	Zinc	0.77 lbs.	50

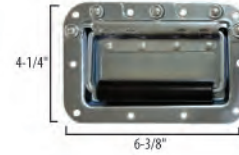

Chest Handles

Item #	Plate Size (Length x Width)	Finish	Wt. lbs.	Qty.
#49432	(A) 3-3/8" x 1-3/4"	Zinc	0.29 lbs.	10
#50416	(B) 4-1/8" x 2-7/8"	Zinc	0.31 lbs.	100



Wall Handles

Item #	Size (Length)	Finish	Wt. lbs.	Qty.
#49103	(A) 6-3/4"	HDG	0.17 lbs.	10
#49428	(B) 13-1/4"	Chrome	0.74 lbs.	10



Universal Gate Handle 6"

Item #	Type	Finish	Wt. lbs.	Qty.
#48209	Handle	Powder Coat	0.20 lbs.	100
#48208	Complete Set	Powder Coat	5.87 lbs.	8



*Latches on page 5, hinges on page 16

Spring Handles

Item #	Size	Hole	Style	Wt. lbs.	Qty.
#47691	4-1/2"	3/8"	Zinc	0.23 lbs.	25
#48239	4-1/2"	3/8"	Bare	0.23 lbs.	20
#49838	5"	3/8"	Stainless	0.29 lbs.	20
#80388	5"	5/8"	Stainless	0.34 lbs.	20
#49450	6"	1/2"	Zinc	0.33 lbs.	20
#49198	6"	5/8"	Bare	0.55 lbs.	20
#49805	6"	1/2"	Stainless	0.33 lbs.	20

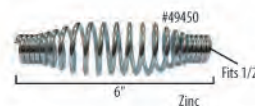

Steel Handle

Item #	Size (Length x Width)	Rod Diameter	Finish	Wt. lbs.	Qty.
#50559	6-1/2" x 2-1/2"	1/2"	Bare	0.45 lbs.	25

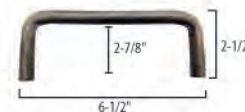

Spring Steel Handles

Item #	Size (Length x Width)	Threaded	Finish	Wt. lbs.	Qty.
#50504	6" x 3-5/8"	No	Bare	0.75 lbs.	20
#80975	6-1/2" x 4-5/8"	Yes	Bare	1.08 lbs.	20

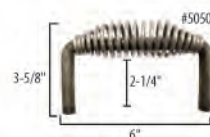

New

Texas Star Pins - Cast Iron

Item #	Size	Width	Finish	Wt. lbs.	Qty.
#50622	Mini	1-13/16"	Bare	0.01 lbs.	25
#50641	S	2-11/16"	Bare	0.01 lbs.	25
#50642	M	3-1/4"	Bare	0.18 lbs.	25
#50643	L	5"	Bare	0.50 lbs.	25



Steel Stars

Item #	Size (Length x Width)	Finish	Wt. lbs.	Qty.
<i>New</i> #81069	4"	Bare	0.29 lbs.	50
<i>New</i> #81070	4-1/2"	Bare	0.35 lbs.	50
<i>New</i> #46141	6"	Powder Coat	0.53 lbs.	25



No Hunting Sign

Item #	Size (Length x Width)	Thickness	Finish	Wt. lbs.	Qty.
<i>New</i> #46118	10" x 15"	11ga	Powder Coat	3.37 lbs.	1



No Trespassing Sign

Item #	Size (Length x Width)	Thickness	Finish	Wt. lbs.	Qty.
<i>New</i> #46119	20" x 15"	11ga	Powder Coat	6.31 lbs.	1



Decorative Horseshoes - Cast Steel

Item #	Size	Width	Height	Finish	Wt. lbs.	Qty.
#49339	S	2-7/8"	3-3/8"	Bare	0.21 lbs.	10
#49340	M	4"	4-1/4"	Bare	0.38 lbs.	10
#49341	L	4-1/2"	4-1/2"	Bare	0.54 lbs.	10
#49342	XL	6"	6-3/4"	Bare	0.91 lbs.	10



**THESE ARE FOR DECORATIVE USE ONLY. DO NOT USE ON HORSES. **

Decorative Horseshoes - Forged Steel

Item #	Size	Width	Height	Finish	Wt. lbs.	Qty.
#50428	Pony	3-1/4"	3-3/4"	Bare	0.37 lbs.	80
#80445	Pony	3-1/4"	3-3/4"	Zinc	0.37 lbs.	80



**THESE ARE FOR DECORATIVE USE ONLY. DO NOT USE ON HORSES. **

Decorative Tractor Seat

Item #	Width	Height	Thickness	Finish	Wt. lbs.	Qty.
#49843	17-1/2"	13-1/2"	14ga	Bare	4.65 lbs.	10



Tractor Seat Bar Stool Weld Kit

Item #	Height	Seat Size	Steel Base	Wt. lbs.	Qty.
#50680	27"-31"	18"	20"	34.00 lbs.	1

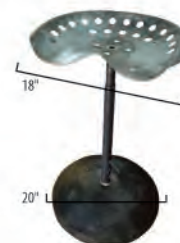

Bottle Openers

Item #	Size (Height x Width)	Finish	Wt. lbs.	Qty.
#49969	3-1/4" x 2-1/2"	Cast Iron	0.32 lbs.	100
#50026	3-3/16" x 2-1/2"	Nickel-plated	0.16 lbs.	100



Bottle Cap Catcher

Item #	Finish	Wt. lbs.	Qty.
#50333	Stainless Steel	0.23 lbs.	10



Bottle Cap Catcher And Opener Kit

Item #	Finish	Wt. lbs.	Qty.
#50548	Stainless Steel	0.45 lbs.	75

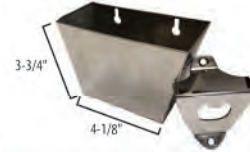

Cast Iron Braces

Item #	Style	Base Size (Length x Width)	Finish	Wt. lbs.	Qty.
#50437	(A) Cross	8-1/4" x 6-1/2"	Bare	0.91 lbs.	40
#50438	(B) Star - Small	7-3/4" x 7-3/4"	Bare	1.35 lbs.	10
#50439	(C) Star - Medium	8-1/2" x 6-3/8"	Bare	1.55 lbs.	20
#80799	(D) Curves	8-1/4" x 9"	Bare	1.49 lbs.	20

New

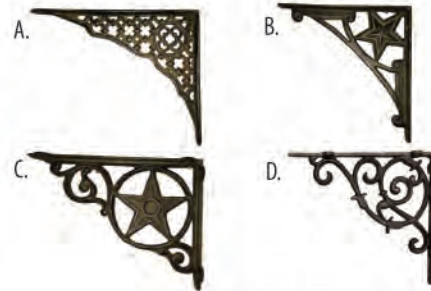

Steel Shelf Bracket

Item #	Base Size (Length x Width)	Finish	Wt. lbs.	Qty.
#50443	8-1/4" X 5-1/4"	Powder Coat	0.45 lbs.	10



Rope Hook

Item #	Width	Height	Finish	Wt. lbs.	Qty.
#49434	1/2"	4-7/8"	Zinc	0.19 lbs.	10



Coat Hook - Swivel

Item #	Base Size (Length x Width)	Finish	Wt. lbs.	Qty.
#50436	5-5/16" x 2-3/16"	Bare	0.85 lbs.	50



Coat Hooks

Item #	Size	Length	Height	Finish	Wt. lbs.	Qty.
#49333	(A) Small	3-1/8"	2-5/16"	Bare	0.19 lbs.	10
#49334	(B) Medium	3"	3"	Bare	0.28 lbs.	10
#49335	(C) Large	3-3/4"	4-3/8"	Bare	0.33 lbs.	10
#50435	(D) XL	7-1/2"	4"	Bare	0.90 lbs.	50

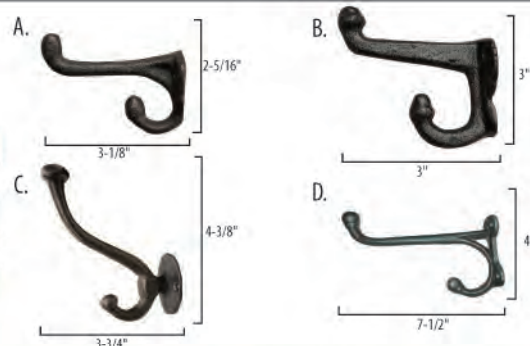

Hand Forged Rustic Hardware

If these doors could talk, the stories they could tell!

Many of these doors are over 500 years old. They all started out new and full of hope. They witnessed history and never gave up their secrets.

This inspired us to search the globe for artists that still fabricate metal hardware one unique handcrafted piece at a time using methods that date back to the Iron Age.

Start your story and who knows what your doors will see in the next 500 years!



More Coming Soon!

Door Pulls

Item #	Style	Size (Length x Depth)	Finish	Wt. lbs.	Qty.
<i>New</i> #80667	(A) Simple	10-7/16" x 2-1/4"	Bare	2.06 lbs.	1
<i>New</i> #80664	(B) Straight	10-5/16" x 2-3/4"	Bare	2.29 lbs.	1
<i>New</i> #80677	(C) Classic	12-1/4" x 3-7/8"	Bare	3.46 lbs.	1
<i>New</i> #80656	(D) Curled	10" x 1-3/4"	Bare	1.03 lbs.	1
<i>New</i> #80675	(E) Classic	11-1/2" x 3-1/8"	Bare	2.91 lbs.	1

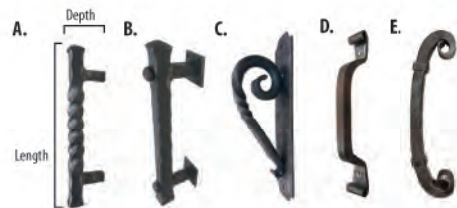

Hammered Push Plates

Item #	Type	Size (Length x Width)	Thickness	Finish	Wt. lbs.	Qty.
<i>New</i> #80693	(A) Italian	14-1/4" x 4-1/4"	3/16"	Bare	2.41 lbs.	10
<i>New</i> #80695	(B) Simple	24-1/4" x 3-3/4"	8ga	Bare	3.69 lbs.	10

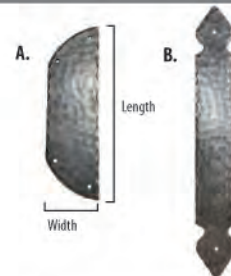

Flush Base Mount - 3-1/2" Post

Item #	Size (Length x Width)	Thickness	Finish	Wt. lbs.	Qty.
<i>New</i> #80657	8" x 3"	3/16"	Bare	2.69 lbs.	10

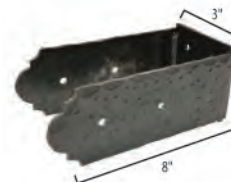

Straight Flat Strap - 6" Post

Item #	Size (Length x Width)	Thickness	Finish	Wt. lbs.	Qty.
<i>New</i> #80666	8-1/2" x 6-1/2"	3/16"	Bare	2.52 lbs.	10

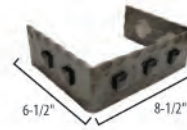

Italian Iron "L" Plate

Item #	Size (Length x Width)	Thickness	Finish	Wt. lbs.	Qty.
<i>New</i> #80680	8-1/4" x 8-3/8"	9ga	Bare	1.28 lbs.	10

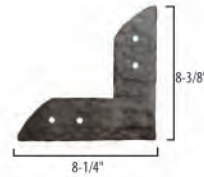

Hammered "T" Plate

Item #	Size (Length x Width)	Thickness	Finish	Wt. lbs.	Qty.
<i>New</i> #80659	14-1/4" x 10-1/4"	9ga	Bare	2.50 lbs.	10



Hammered Washers

Item #	Style	Size (Length x Width)	Thickness	Finish	Wt. lbs.	Qty.
<i>New</i> #80654	(A) Diamond	1-1/4" x 1-1/4"	3/16"	Bare	0.07 lbs.	1
<i>New</i> #80662	(B) Colonial	2" x 2"	3/16"	Bare	0.16 lbs.	1
<i>New</i> #80673	(C) Square	1-1/4" x 1-1/4"	3/16"	Bare	0.08 lbs.	1

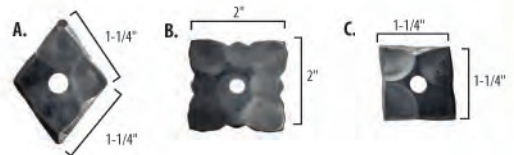

Hammered Faux Hinges

Item #	Style	Size (Length x Width)	Finish	Wt. lbs.	Qty.
<i>New</i> #80672	(A) Round Iron	18-1/4" x 2-3/8"	Bare	1.90 lbs.	10
<i>New</i> #80655	(B) Essex Iron	18-1/4" x 2-3/8"	Bare	1.85 lbs.	10
<i>New</i> #80676	(C) Classic Iron	18-3/4" x 3"	Bare	2.14 lbs.	10
<i>New</i> #80660	(D) Colonial	18-1/2" x 2-1/2"	Bare	1.43 lbs.	10
<i>New</i> #80663	(E) Estate	18-5/8" x 3-7/8"	Bare	1.37 lbs.	10
<i>New</i> #80679	(F) Italian	18-1/4" x 2-1/2"	Bare	1.38 lbs.	10



Hammered Hinge

Item #	Size (Length x Width)	Thickness	Finish	Wt. lbs.	Qty.
<i>New</i> #80681	6" x 2-3/4"	3/16"	Bare	0.89 lbs.	10

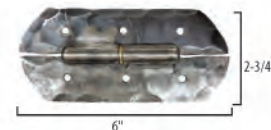

Hammered Hinge Strap

Item #	Size (Length x Width)	Thickness	Finish	Wt. lbs.	Qty.
<i>New</i> #80692	47-1/2" x 17"	3/16"	Bare	8.43 lbs.	1



Cast Iron Drop Latch - 7-1/2"

Item #	Finish	Wt. lbs.	Qty.
#80813	Powder Coat	1.27 lbs.	10

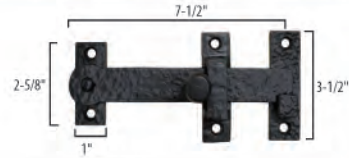

Cast Iron Ring Latch Kit

Item #	Finish	Wt. lbs.	Qty.
#80820	Powder Coat	3.18 lbs.	10



Cast Iron Lever Latch Kit

Item #	Finish	Wt. lbs.	Qty.
#80821	Powder Coat	3.61 lbs.	10



Cast Iron Drop Latch Kit

Item #	Finish	Wt. lbs.	Qty.
#80815	Powder Coat	2.36 lbs.	10

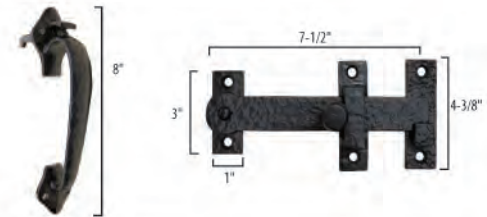

Cast Iron Drop Latch Kit - Spade

Item #	Finish	Wt. lbs.	Qty.
#80816	Powder Coat	2.18 lbs.	10

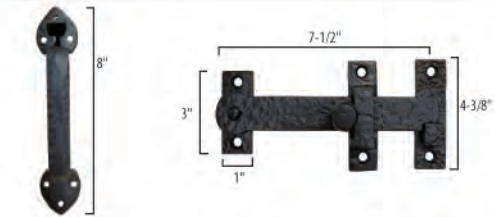

Cast Iron Handles

Item #	Style	Size (Width X Height)	Finish	Wt. lbs.	Qty.
#80810	(A) Original	1-7/8" x 8"	Powder Coat	0.71 lbs.	10
#80811	(B) Spade	1-3/4" x 8"	Powder Coat	0.62 lbs.	10
#50425	(C) Fleur-De-Lis	2-1/8" x 6-3/4"	Powder Coat	0.45 lbs.	90

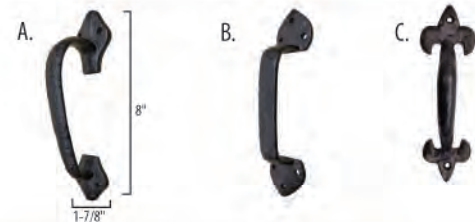

If you need help with an order, have questions about our products, or have an inquiry about setting up an account, please contact a member of our team today!

*We'd love to hear from you!
1-866-651-6702 or sales@springcreekproducts.com*

Cast Iron Decorative Handles

Item #	Size (Length x Width)	Inside Width	Finish	Wt. lbs.	Qty.
#49336	(A) 5-5/8" x 2"	3-5/16"	Bare	0.49 lbs.	10
#49337	(B) 8-3/4" x 2"	5"	Bare	0.84 lbs.	10
#49338	(C) 8-3/4" x 2-3/8"	4-1/2"	Bare	1.16 lbs.	30

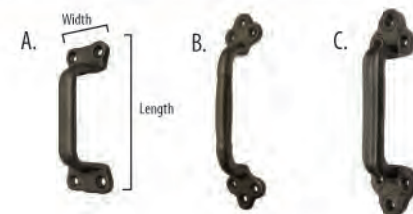

Cast Iron Strap Hinge - 5" Tee

Item #	Size (Length x Height)	Thickness	Finish	Wt. lbs.	Qty.
#80817	7" x 4-5/16"	3/16"	Powder Coat	1.49 lbs.	10



Cast Iron Flat Hinges

Item #	Style	Size (Length x Height)	Thickness	Finish	Wt. lbs.	Qty.
#80812	(A) 5"	5-1/4" x 5"	3/16"	Powder Coat	1.63 lbs.	10
#80819	(B) 6"	11-1/4" x 2-3/8"	1/4"	Powder Coat	1.58 lbs.	10

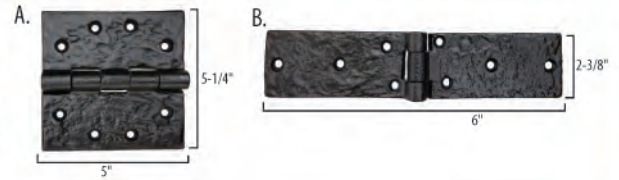

Cast Iron Strap Hinges

Item #	Style	Size (Length x Height)	Thickness	Finish	Wt. lbs.	Qty.
#80818	(A) Single	9-1/2" x 4-1/4"	1/4"	Powder Coat	1.27 lbs.	10
#80814	(B) Double	15" x 3-3/4"	1/4"	Powder Coat	1.19 lbs.	10

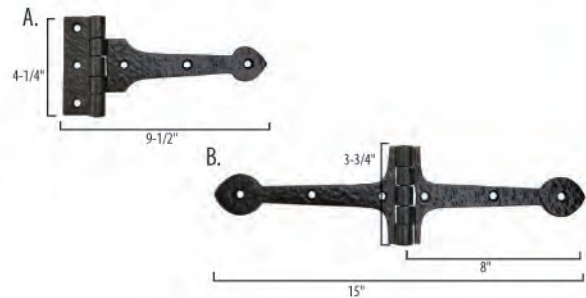

Tubular Handrail

Item #	Size (Width x Length)	Thickness	Finish	Wt. lbs.	Qty.
#50789	1-5/8" x 8'	14ga	Bare	9.84 lbs.	1

This item does not qualify for free freight.



Rail Clips

Item #	Type	Width	Thickness	Finish	Wt. lbs.	Qty.
#48452	Flat Tab	2-3/4"	9ga	Bare	0.50 lbs.	10 / box 2,000 / drum
#49821	Bent Tab	2-3/4"	9ga	Bare	0.50 lbs.	100 / box 2,000 / drum

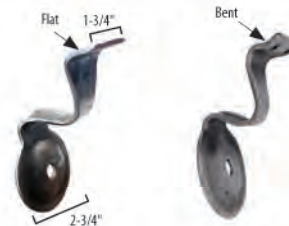

Bolt On Rail Flanges

Item #	Size (Pipe fits)	Finish	Wt. lbs.	Qty.
#49807	1.25" O.D.	Bare	0.26 lbs.	50
#49806	1.75" O.D.	Bare	0.34 lbs.	100
#49732	1.90" O.D.	Bare	0.43 lbs.	50



Handrail End Caps

Item #	Cast Iron Type	Size (Width x Length)	Finish	Wt. lbs.	Qty.
#80639	(A) Straight	2-5/8" x 4-1/8"	Bare	1.14 lbs.	20
#80640	(B) Beveled	3-5/8" x 3-3/4"	Bare	0.85 lbs.	20
#80641	(C) Volute	3" x 2-1/4"	Bare	1.49 lbs.	20
#80642	(D) Cap	2-1/8" x 1-5/8"	Bare	0.49 lbs.	20
#80643	(E) Flange	2-3/16" x 3-11/16"	Bare	0.49 lbs.	20

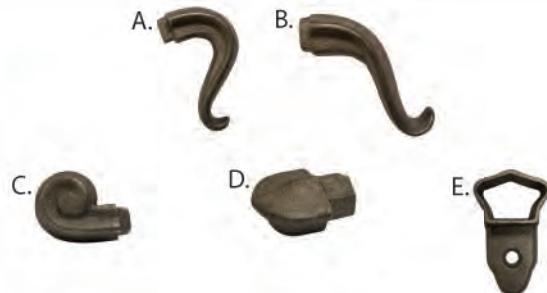

"S" Hooks

Item #	Size	Finish	Capacity	Wt. lbs.	Qty.
#80287	3/8"	Zinc	1,200 lbs.	0.47 lbs.	12
#80289	7/16"	Zinc	2,500 lbs.	0.69 lbs.	12

Packaged with two "S" hooks



Hitch Pins Bent

Item #	Size	Finish	Wt. lbs.	Qty.
#80288	5/8" x 3"	Zinc	0.50 lbs.	12 *
<i>New</i> #80725	5/8" x 3"	Zinc	0.52 lbs.	50 *Bulk Item

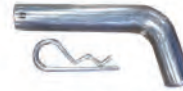

Safety Chain With "S" Hooks

Item #	Size (Diameter x Length)	Capacity	Finish	Wt. lbs.	Qty.
#80292	3/8" x 36"	3,000 lbs.	Zinc	1.60 lbs.	5 *
#80294	7/16" x 36"	5,000 lbs.	Zinc	2.60 lbs.	5 *
<i>New</i> #80998	7/16" x 36"	5,000 lbs.	Zinc	2.60 lbs.	40 *Bulk Item



Safety Chain With Clevis Hooks

Item #	Size (Diameter x Length)	Capacity	Finish	Wt. lbs.	Qty.
#80296	5/16" x 30"	7,600 lbs.	Zinc	3.06 lbs.	3



Round Snap Pin With Chain

Item #	Size	Finish	Wt. lbs.	Qty.
#80365	5/16"	Zinc	0.19 lbs.	6



Wheel Bearing Kits

Item #	Size	Fits	Wt. lbs.	Qty.
#80319	1"	BT8 Spindle	0.56 lbs.	12
#80317	1-1/16"	BTR Spindle	0.56 lbs.	12

Kits include: 2 bearings, 2 races, 1 seal, and 1 cotter pin.



Hub Kits - Replacement Parts

Item #	Number of Bolts	Bolt Circle	Weight Capacity	Fits	Wt. lbs.	Qty.
#80318	5	4-1/2"	1,750 lbs.	#84 Spindle	8.98 lbs.	1
#80320	5	4-1/2"	1,250 lbs.	BT16 Spindle	7.22 lbs.	1
#80321	4	4"	1,250 lbs.	BT8 Spindle	6.63 lbs.	1



Trailer Jack Foot

Item #	Finish	Wt. lbs.	Qty.
#80323	Zinc	2.25 lbs.	1



Trailer Plug - 3 Prong

Item #	Type	Wt. lbs.	Qty.
#80368	12V	0.13 lbs.	12



Trailer Plug - 7 Way

Item #	Type	Wt. lbs.	Qty.
#80366	(A)	0.25 lbs.	6
#80367	(B)	0.22 lbs.	8 *



Hitch Balls

Item #	Ball Size	Weight Capacity	Shank Length	Shank Diameter	Wt. lbs.	Qty.
#80305	1-7/8"	2,000 lbs.	2-1/2"	3/4"	1.87 lbs.	4
#80304	2"	3,500 lbs.	2"	3/4"	1.75 lbs.	12 *
#80299	2"	3,500 lbs.	2-3/4"	3/4"	2.20 lbs.	12
#80293	2"	5,000 lbs.	2-3/4"	1"	2.65 lbs.	12
#80295	2-5/16"	6,000 lbs.	2-1/8"	1"	3.25 lbs.	12
#80306	2-5/16"	7,500 lbs.	2-1/4"	1-1/4"	3.81 lbs.	3

*TV and Garden Tractor feature.



Square Receiver Sleeve

Item #	Size	Finish	Wt. lbs.	Qty.
#80372	2"	Powder Coat	3.18 lbs.	1



Ball Mounts

Item #	Drop Distance	Length	Finish	Weight Capacity	Wt. lbs.	Qty.
#80297	2"	8-1/2"	Powder Coat	6,000 lbs.	5.69 lbs.	1
#80303	4"	10-1/2"	Powder Coat	5,000 lbs.	7.69 lbs.	4



Ball Mount Kits

Item #	Drop Distance	Hitch Ball Size	Finish	Weight Capacity	Wt. lbs.	Qty.
#80302	2"	1-7/8"	Powder Coat	2,000 lbs.	8.31 lbs.	2
#80291	2"	2"	Powder Coat	6,000 lbs.	8.71 lbs.	2
#80298	4"	2"	Powder Coat	5,000 lbs.	10.20 lbs.	2

*Kit includes: hitch ball, mount, and R-pin



Dual-Ball Mount

Item #	Ball Size	Weight Capacity	Finish	Wt. lbs.	Qty.
#80626	2" & 2-5/16"	5,000 - 7,500 lbs.	Powder Coat	8.84 lbs.	2



Tri-Ball Mounts

Item #	Ball Size	Weight Capacity	Finish	Wt. lbs.	Qty.
#80300	1-7/8", 2", & 2-5/16"	2,000 - 10,000 lbs.	Powder Coat	17.75 lbs.	2
#80301	1-7/8", 2", & 2-5/16"	2,000 - 10,000 lbs.	Chrome	17.75 lbs.	2



Aluma-Tow Adjustable Mounts

Item #	Drop	Receiver Size	Ball Size	Finish	Weight Capacity	Wt. lbs.	Qty.
#80307	6"	2"	1-7/8", 2", & 2-5/16"	Chrome	12,000 lbs.	21.15 lbs.	2
#80322	8"	2"	1-7/8", 2", & 2-5/16"	Chrome	12,000 lbs.	23.16 lbs.	2



Marker LED Light - Red/Round

Item #	Size	Grommet	Wt. lbs.	Qty.
#80370	2"	Yes	0.19 lbs.	12



Trailer LED Lights - Red/Round

Item #	Size	Grommet	Wt. lbs.	Qty.
#80354	4"	Yes	0.57 lbs.	6
#80632	4"	No	0.32 lbs.	6



Trailer LED Light - Amber/Round

Item #	Size	Grommet	Wt. lbs.	Qty.
#80397	2-1/2"	Yes	0.23 lbs.	10



Trailer LED Light - Amber/Round

Item #	Size	Grommet	Wt. lbs.	Qty.
#80369	2"	No	0.06 lbs.	10



Trailer 10 LED Light - Red/Oval

Item #	Size	Grommet	Wt. lbs.	Qty.
#80355	6-1/2" x 2-1/4"	Yes	0.34 lbs.	6



Trailer LED Lights - Red/Oval

Item #	Number of Lights	Grommet	Wt. lbs.	Qty.
#80356	6	Yes	0.50 lbs.	6
#80371	10	Yes	0.50 lbs.	6



Trailer LED ID Bar Lights

Item #	Style	Wt. lbs.	Qty.
#80360	Chrome	0.44 lbs.	12
#80361	Black	0.31 lbs.	12



Trailer LED Lights - Clear/Square

Item #	Type	Wt. lbs.	Qty.
#80358	Streetside	0.75 lbs.	6
#80357	Curbside	0.50 lbs.	6

Curbside



Streetside



Trailer LED Lights - Red/Square

Item #	Size	Wt. lbs.	Qty.
#80352	4-1/2" - Right	0.69 lbs.	6
#80353	4-1/2" - Left	0.69 lbs.	6



Trailer Light - Red/Round

Item #	Size	Grommet	Wt. lbs.	Qty.
#80313	4"	Yes	0.47 lbs.	6



Trailer Light - Red/Oval

Item #	Size	Grommet	Wt. lbs.	Qty.
#80314	6-1/2" x 2-1/4"	Yes	0.50 lbs.	6



Trailer Lights - Red/Square

Item #	Size	Wt. lbs.	Qty.
#80309	4-1/2" - Right	0.50 lbs.	6
#80310	4-1/2" - Left	0.50 lbs.	6



Reflective Tape Kit

Item #	Size (Length x Width)	Wt. lbs.	Qty.
#80312	12" x 2"	0.12 lbs.	1

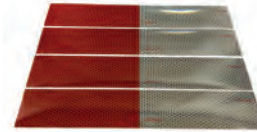

Towing Light Kit

Item #	Wt. lbs.	Qty.
#80316	2.51 lbs.	6



Submersible LED Light Kit - Red

Item #	Wt. lbs.	Qty.
#80315	2.53 lbs.	1



Submersible LED Light Kit - Clear

Item #	Wt. lbs.	Qty.
#80359	2.53 lbs.	1



Towing LED Light Kit

Item #	Wt. lbs.	Qty.
#80362	4.25 lbs.	1



Submersible Light Kit - Incandescent

Item #	Wt. lbs.	Qty.
#80311	2.42 lbs.	12



Stall And Trailer Latches

Item #	Style	Size (Length x Width)	Pin	Finish	Wt. lbs.	Qty.
#50070	4-1/2" - Left	4-1/2" x 5-7/8"	1/2"	Bare	0.88 lbs.	10
#50071	4-1/2" - Right	4-1/2" x 5-7/8"	1/2"	Bare	0.88 lbs.	10
#47017	6" - Left	6" x 6-3/16"	1/2"	Bare	0.69 lbs.	30
#47018	6" - Right	6" x 6-3/16"	1/2"	Bare	0.69 lbs.	30

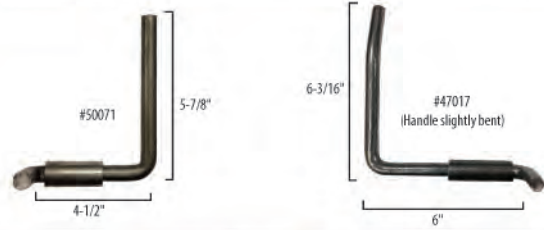

Extra Heavy-Duty Draw Latch

Item #	Size	Finish	Handle	Wt. lbs.	Qty.
<i>New</i> #80779	7"	Powder Coat	Yellow	7.04 lbs.	5



Trailer Bar Latch Kit

Item #	Part	Finish	Wt. lbs.	Qty.
#50549	Kit	Bare	5.60 lbs.	1
#50571	Top Keeper	Bare	1.00 lbs.	25
#50572	Top Lug	Bare	0.55 lbs.	50
#50573	Top Pipe Holder, fits 1.05"	Bare	0.20 lbs.	50
#50574	Bottom Pipe Holder, fits 1.05"	Bare	0.20 lbs.	50
#50575	Handle	Bare	1.30 lbs.	50
#50576	Hasp for Handle	Bare	0.45 lbs.	50
#50577	Bottom Keeper	Bare	1.00 lbs.	25
#50578	Bottom Lug	Bare	0.55 lbs.	50



7-3/8" Dump Trailer Hinge With Grease Zerk

Item #	Size (Length x Width)	Plate Thickness	Finish	Wt. lbs.	Qty.
#80251	7-1/2" x 4-1/4"	3/8"	Bare	3.38 lbs.	10



Formed Hinge Straps

Item #	Size (Length x Width)	Leaf Length	Style	Finish	Wt. lbs.	Qty.
#50128	4-1/4" x 2-1/4"	1"	Left	Bare	2.14 lbs.	10
#80770	4-1/4" x 2-1/4"	1"	Right	Bare	2.14 lbs.	10
#50292	6-1/8" x 2-1/4"	3"	Right	Bare	2.55 lbs.	10



Trailer Vents

Item #	Size	Center Hole	Finish	Wt. lbs.	Qty.
<i>New</i> #80981	4" x 11ga	1/4"	Bare	0.24 lbs.	10
<i>New</i> #80982	6" x 11ga	3/8"	Bare	0.55 lbs.	10
<i>New</i> #80983	8" x 11ga	3/8"	Bare	0.98 lbs.	10



Trailer Jack Holder

Item #	Size (Length x Width)	Thickness	Finish	Wt. lbs.	Qty.
#80700	5" x 1-1/8"	14ga	Bare	0.21 lbs.	50



Chain Retainers

Item #	Pin Size	Overall Length	Fits	Finish	Wt. lbs.	Qty.
#80026	3/8"	3-7/8"	5/16"	Bare	0.61 lbs.	40
#80027	1/2"	4-1/2"	3/8"	Bare	0.97 lbs.	30



7-1/4" Steel Handle

Item #	Diameter	Size (Length x Height)	Finish	Wt. lbs.	Qty.
#80179	5/8"	7-1/4" x 1-3/4"	Bare	0.63 lbs.	50



Trailer Rope Hooks

Item #	Diameter	Size (Length x Height)	Type	Finish	Wt. lbs.	Qty.
#49697	3/8"	2-1/4" x 3-13/16"	Straight	Bare	0.22 lbs.	10
#50269	1/2"	2-3/8" x 3-3/8"	Straight	Bare	0.32 lbs.	100
#50270	3/4"	2-1/2" x 4"	Straight	Bare	0.75 lbs.	25
#50268	1/2"	2-3/8" x 4"	Offset	Bare	0.35 lbs.	25

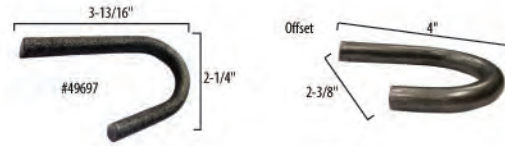

Round Steel Pin

Item #	Size (Diameter x Length)	Finish	Wt. lbs.	Qty.
#50391	3/4" x 3"	Bare	0.35 lbs.	50



Trailer Floor Screw

Item #	Size (Diameter x Length)	Finish	Wt. lbs.	Qty.
#50197	5/16" x 2-1/2"	Bare	0.05 lbs.	600



Weld On Stake Pockets

Item #	Size (Length x Height x Depth)	Thickness	Finish	Wt. lbs.	Qty.
#49680	4" x 1-3/4" x 3"	4ga	Bare	1.30 lbs.	20
#50022	4" x 1-3/4" x 3"	7ga	Bare	0.95 lbs.	20

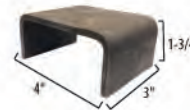

Trailer Door - Hook And Key

Item #	Finish	Wt. lbs.	Qty.
#50158	HDG	0.35 lbs.	10

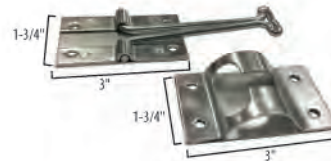

Lashing Rings - Weld On

Item #	Size	Working L.L.	MBS	Inner Diameter (Width x Height)	Outer Diameter (Width x Height)	Finish	Wt. lbs.	Qty.
#48195 #80460	1/2"	4,000 lbs.	12,000 lbs.	2-1/4" x 2-1/2"	3-1/4" x 3-1/2"	Bare	0.94 lbs.	20/box 500/crate
#48196 #80193	5/8"	6,000 lbs.	18,000 lbs.	3" x 3"	4-1/4" x 4-1/4"	Bare	1.90 lbs.	20/box 500/crate
#48197	3/4"	8,833 lbs.	26,500 lbs.	3" x 3"	4-1/2" x 4-1/2"	Bare	2.50 lbs.	10
#48198	1"	15,666 lbs.	47,000 lbs.	3" x 3"	5" x 5"	Bare	4.16 lbs.	10
#50341 #80364	1"	15,586 lbs.	47,000 lbs.	3" x 4"	5" x 6"	Bare	4.65 lbs.	8/box 256/crate



HORSE STALL CHANNELS

**CREATE YOUR OWN SPECIAL LOOK FOR A FRACTION OF THE PRICE OF
 PREBUILT STALLS AND DOORS!**

These channels can be easily attached to wood or steel posts using self drilling screws.
 Wood planks slide in between the channels and can be easily added or removed
 to adjust your barrier height.

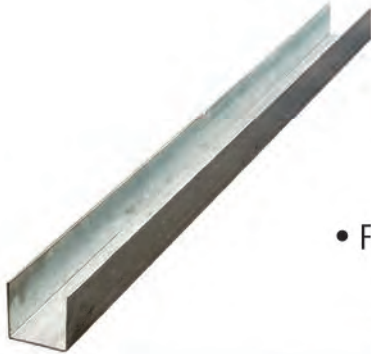

- Suits 2" wooden planks any height (4", 6", 8", etc.)
- Fits perfectly into these inexpensive channels
 - Comes in 6', 8', 10', or 12' lengths
 - Available in bare or galvanized finish

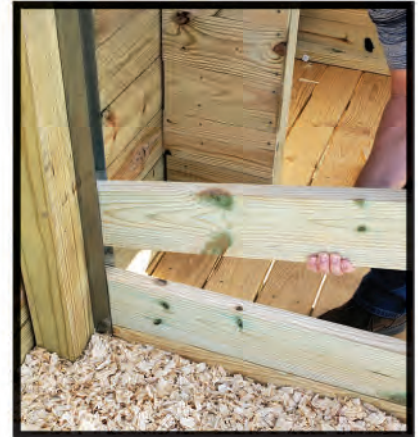

Horse Stall Channels

Sturdy formed steel channel, 1-5/8" long on all three sides. Can be bolted or welded to most surfaces such as wood, steel, or concrete.

Galvanized

Item #	Length	Thickness	Wt. lbs.	Qty.
<i>New</i> #80976	6'	16ga	6.00 lbs.	1
#50535	8'	16ga	8.00 lbs.	1
#50536	10'	16ga	10.00 lbs.	1
#80459	10'	14ga	12.96 lbs.	1
#50537	12'	16ga	12.00 lbs.	1

Bare

Item #	Length	Thickness	Wt. lbs.	Qty.
<i>New</i> #81537	6'	16ga	6.00 lbs.	1
#80454	8'	16ga	8.00 lbs.	1
#80455	10'	16ga	10.00 lbs.	1
#80456	12'	16ga	12.00 lbs.	1

These items do not qualify for free freight



Hay Bale Spears



Loop and Pin Style - Set

Item #	Type	Finish	Wt. lbs.	Qty.
#49811	Spear and Sleeve Set - 39"	Painted	21.50 lbs.	1
#49809	Spear and Sleeve Set - 48"	Painted	26.94 lbs.	1

Replacement Pieces

Item #	Type	Finish	Wt. lbs.	Qty.
#50111	Sleeve Only	Zinc	3.30 lbs.	1
#49858	Linchpin - 3/8" x 2-1/2"	Zinc	0.14 lbs.	1



Tapered Sleeve and Nut Style

Item #	Type	Finish	Wt. lbs.	Qty.
#49812	Spear and Sleeve Set - 39"	Painted	21.50 lbs.	1
#49810	Spear and Sleeve Set - 48"	Painted	26.94 lbs.	1

Replacement Pieces

Item #	Type	Finish	Wt. lbs.	Qty.
#50112	Sleeve Only	Zinc	3.30 lbs.	1
#81045	Threaded Nut	Bare	0.31 lbs.	1

****Bale Spears are guaranteed for 1 year from date of purchase. Only for moving hay bales.**

Bale Spear Bracket

Item #	Plate Size (Length x Height)	Finish	Wt. lbs.	Qty.
#49813	4-7/8" x 7-7/8"	Powder Coat	11.58 lbs.	1



Ground Anchor Spiral

Item #	Size (Diameter x Length)	Finish	Wt. lbs.	Qty.
#50461	3/8" x 10"	Powder Coat	1.38 lbs.	25

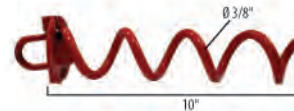

Landscape Stake

Item #	Size	Finish	Wt. lbs.	Qty.
#47667	1/4" x 1"	Bare	0.60 lbs.	1,500



Landscape Edge

Item #	Size (Length x Width x Height)	Finish	Wt. lbs.	Qty.
#47021	10' x 1/8" x 3-7/8"	Powder Coat	17.00 lbs.	100

This item does not qualify for free freight



Tree Stake Kit

Item #	Stakes	Wire	Finish	Wt. lbs.	Qty.
#50182	5/8" x 24"	1/8" x 8"	Bare	6.30 lbs.	5

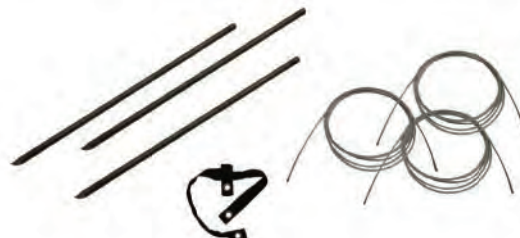

FARM AND RANCH RANCH ACCESSORIES

Freeze Miser®

Item #	Wt. lbs.	Qty.
<i>New</i> #80974	0.29 lbs.	16



No Hunting Sign

Item #	Size (Length x Width)	Thickness	Finish	Wt. lbs.	Qty.
<i>New</i> #46118	10" x 15"	11ga	Powder Coat	3.37 lbs.	1



No Trespassing Sign

Item #	Size (Length x Width)	Thickness	Finish	Wt. lbs.	Qty.
<i>New</i> #46119	20" x 15"	11ga	Powder Coat	6.31 lbs.	1



Propane Gas Torch

Item #	Wt. lbs.	Qty.
#50146	3.00 lbs.	10

PROPRANE TANK NOT INCLUDED



Steel Plate Targets

Item #	Size	Thickness	Finish	Wt. lbs.	Qty.
#80403	6"	3/8"	Zinc	3.06 lbs.	1
#80404	8"		Zinc	5.44 lbs.	1
#80405	10"		Zinc	8.50 lbs.	1
#80406	6"	1/2"	Zinc	3.69 lbs.	1
#80407	8"		Zinc	6.51 lbs.	1
#80408	10"		Zinc	10.19 lbs.	1



Target Holder Set

Item #	Pipe Size	Finish	Wt. lbs.	Qty.
<i>New</i> #80989	1-1/4"	Powder Coat	2.09 lbs.	20



Keypad Mounts For Automatic Gates

Item #	Type	Size (Length x Width x Thickness)	Wt. lbs.	Qty.
#80634	Square	71-1/4" x 2" x 14ga	14.50 lbs.	1
#80635	Round	71-1/4" x 1.66" OD x 11ga	13.40 lbs.	1

These items do not qualify for free freight





Decorative Hammered Items
(pages 28-29)



Decorative Horseshoes
(page 26)

Check out these rustic options to spruce up your ranch!



Letters And Numbers
(page 77)

FARM AND RANCH GATE ACCESSORIES

Wood Post Lockable Gate Latches

Item #	Size (Length x Width x Depth)	Finish	Wt. lbs.	Qty.
#80271	21-1/2" x 6-1/8" x 2"	Powder	5.22 lbs.	5
#80272	21-1/2" x 6-1/8" x 2"	Powder	5.22 lbs.	140 *Bulk Item



Cowboy Latch

Item #	Mounting Plate (Length x Width)	Pin	Finish	Wt. lbs.	Qty.
#50639	26" x 4"	1"	Bare	20.0 lbs.	1

This item does not qualify for free freight.



17" Gate Anchor

Item #	Size (Length x Width)	Fits Pipe	Finish	Wt. lbs.	Qty.
#50669	17" x 2-3/8"	1-3/4" & 2"	Zinc	3.65 lbs.	8



Gate Cane Bolt With Brackets

Item #	Size	Pin Size	Finish	Wt. lbs.	Qty.
#49822	12"	1/2"	Zinc	1.00 lbs.	20
#49823	18"	1/2"	Zinc	1.45 lbs.	10
#49824	24"	5/8"	Zinc	2.65 lbs.	10

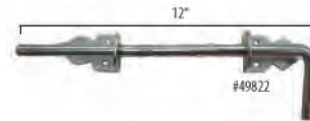

Lockable Heavy-Duty Cane Bolt

Item #	Size	Pin Size	Finish	Wt. lbs.	Qty.
#80477	20"	3/4"	Painted	4.80 lbs.	10



T-Post Driver - Heavy-Duty

Item #	Length	Finish	Wt. lbs.	Qty.
#47935	30"	Powder Coat	14.00 lbs.	1

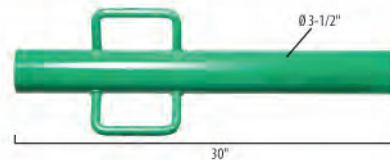

T-Post Puller

Item #	Size (Length x Width)	Finish	Wt. lbs.	Qty.
#80273	7-1/2" x 3-3/16"	Painted	2.36 lbs.	1

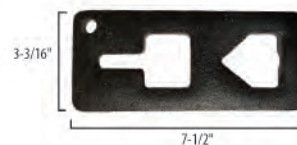

Tie Wire Roll

Item #	Size (Diameter x Length)	Finish	Wt. lbs.	Qty.
<i>New</i> #81097	16ga x 330'	Bare	3.50 lbs.	20



Cable Puller

Item #	Finish	Wt. lbs.	Qty.
#80627	Zinc	5.01 lbs.	6



Fence Stretchers

Item #	Length	Finish	Wt. lbs.	Qty.
#80628	56"	Zinc	28.40 lbs.	1
#80629	66"	Zinc	37.00 lbs.	1
#80723	102"	Zinc	54.50 lbs.	1



These items do not qualify for free freight

Replacement Wedges

Item #	Finish	Wt. lbs.	Qty.
#80630	Zinc	1.34 lbs.	20



Wire Gripper

Item #	Finish	Wt. lbs.	Qty.
#47623	Painted	0.84 lbs.	15



Fence Wire Stretcher

Item #	Finish	Wt. lbs.	Qty.
<i>New</i> #80978	Powder Coat	9.24 lbs.	1



Cable Grips

Item #	Size	Length	Finish	Wt. lbs.	Qty.
#48457	1/4"	20-5/8"	Galvanized	0.32 lbs.	50
#46488	5/16"	22-1/4"	Galvanized	0.56 lbs.	50
#46640	3/8"	31"	Galvanized	1.06 lbs.	50
#46489	7/16"	35"	Galvanized	1.70 lbs.	25
#46641	1/2"	40"	Galvanized	2.40 lbs.	25

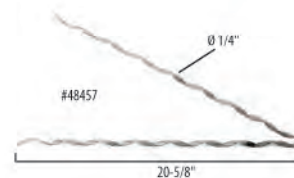

Cable Springs

Item #	Size (Thickness x OD x Length)	Finish	Wt. lbs.	Qty.
#80104	5/16" x 1-3/4" 11-1/2"	Painted	3.00 lbs.	10 / box
#47959				200 / drum



Cable Spring - Closed Loop

Item #	Size (Thickness x OD x Length)	Finish	Wt. lbs.	Qty.
#80230	1/4" x 1-1/2" 11"	Bare	2.60 lbs.	10

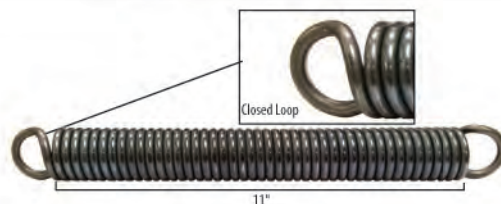

FARM AND RANCH CHAIN KEEPERS

Chain Keepers

Item #	Size (Length x Width)	Thickness	Chain Opening	Finish	Wt. lbs.	Qty.
#47677	4-3/8" X 3-3/16"	3/16"	1/4"	Bare	0.24 lbs.	60
#50008	4-7/16" X 3-1/4"	9 ga	7/16"	Zinc	0.20 lbs.	100

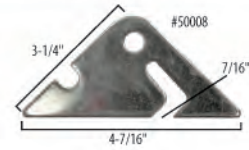

Heavy-Duty Chain Keeper

Item #	Size (Length x Width)	Thickness	Chain Opening	Finish	Wt. lbs.	Qty.
#49876	4-3/4" x 3-7/16"	1/4"	5/16"	Bare	0.35 lbs.	100



Three-Hole Chain Keeper

Item #	Size (Length x Width)	Thickness	Chain Opening	Finish	Wt. lbs.	Qty.
#49971	5-1/2" x 2-3/4"	7ga	5/16"	Bare	0.35 lbs.	100

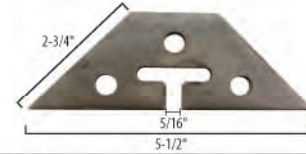

Key Hole Chain Keeper With Notch

Item #	Size (Length x Width)	Thickness	Chain Opening	Finish	Wt. lbs.	Qty.
#50119	3" x 1-1/2"	3/16"	1/4"	Zinc	0.15 lbs.	100

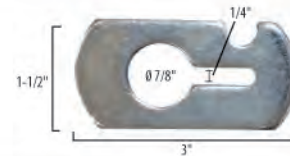

Square Key Hole Chain Keeper

Item #	Size (Length x Width)	Thickness	Chain Opening	Finish	Wt. lbs.	Qty.
#50020	2-1/2" x 2-1/2"	3/16"	1/4"	Bare	0.23 lbs.	150

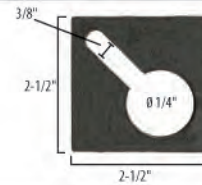

Key Hole Chain Keeper

Item #	Size (Length x Width)	Thickness	Chain Opening	Finish	Wt. lbs.	Qty.
#50631	3-1/2" x 2"	3/16"	1-3/8"	Bare	0.20 lbs.	100
#80077	3-7/16" x 2"	1/4"	1-1/4"	Bare	0.32 lbs.	100

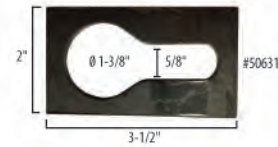

Triangular Heavy-Duty Chain Keeper

Item #	Size (Length x Width)	Thickness	Chain Opening	Finish	Wt. lbs.	Qty.
#50021	7-7/8" x 5-11/16"	1/4"	1/2"	Bare	1.20 lbs.	25

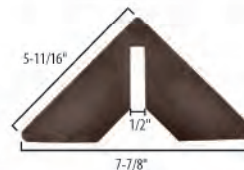

Chain Keeper Heavy-Duty

Item #	Size (Length x Width)	Thickness	Chain Opening	Finish	Wt. lbs.	Qty.
#80209	4-5/8" x 3-3/8"	1/4"	1/4"	Bare	0.32 lbs.	50



Chains

Item #	Style	Size (Length x Thickness)	Finish	Wt. lbs.	Qty.
#49964	Light	30" x 3/16"	Zinc	0.54 lbs.	50
#50009	Light	34" x 7ga	Zinc	0.67 lbs.	50
#49973	Light	36" x 7ga	HDG	0.79 lbs.	50 / box 1,250 / drum
#49974	30 Proof	36" x 4ga	HDG	1.30 lbs.	50 / box 500 / drum



Deluxe Cable Clip

Item #	Accommodates Cable/Rod	Size (Length x Width)	Thickness	Finish	Wt. lbs.	Qty.
#46442	3/4"	4" x 3/4"	1/8"	Bare	0.11 lbs.	500



Fence Clip

Item #	Accommodates Pipe	Size (Length x Width)	Thickness	Finish	Wt. lbs.	Qty.
#49028	1-1/4" O.D.	5-3/8" x 1"	12ga	Bare	0.17 lbs.	200



Cable Clips

Item #	Accommodates Pipe	Size (Length x Diameter)	Finish	Wt. lbs.	Qty.
#45919	3/4" O.D.	2-7/8" x 1/4"	Bare	0.05 lbs.	300/box
#46597					13,500/drum
#46586	1" O.D.	4" x 5/16"	Bare	0.11 lbs.	200/box
#46598					12,150/drum
#47675	1" O.D.	4-7/16" x 3/8"	Bare	0.17 lbs.	210

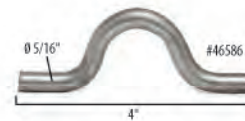

Continuous Cable Clips

Item #	Accommodates Pipe	Size (Length x Width)	Finish	Wt. lbs.	Qty.
#80124	1/2"	2-1/8" x 3/4"	Bare	0.04 lbs.	100
#80125	5/8"	2-5/8" x 7/8"	Bare	0.07 lbs.	100
#80126	3/4"	3" x 1"	Bare	0.12 lbs.	100
#80127	1"	4-1/8" x 1-1/4"	Bare	0.24 lbs.	100



Pipe Clips

Item #	Accommodates Pipe	Size (Length x Diameter)	Finish	Wt. lbs.	Qty.
#50427	1-1/4" O.D.	4-7/8" x 5/16"	Bare	0.13 lbs.	100
#49467	2-3/8" O.D.	7-1/4" x 3/8"	Bare	0.30 lbs.	200



Fence Clips

Item #	Accommodates Pipe	Size (Length x Width)	Thickness	Finish	Wt. lbs.	Qty.
#80395	2-3/8" O.D.	6" x 3/4"	3/16"	Bare	0.31 lbs.	100
#80396	2-7/8" O.D.	7-3/8" x 3/4"	3/16"	Bare	0.41 lbs.	100



Continuous Fence Clips - Square Ends

Item #	Size (O.D.)	Gauge	Hole	Finish	Wt. lbs.	Qty.
#46994	1-1/4"	12	1/4"	Bare	0.10 lbs.	200
#49841	1-1/4"	10	3/8"	Bare	0.20 lbs.	100
#50532	1-1/2"	10	3/8"	Bare	0.20 lbs.	100
#46995	1-5/8"	12	1/4"	Bare	0.12 lbs.	400
#49874	1-5/8"	10	1/4"	Bare	0.20 lbs.	200
#80028	1-5/8"	10	3/8"	Bare	0.23 lbs.	100
#46996	1-7/8"	12	1/4"	Bare	0.14 lbs.	200
#49468	2-3/8"	3/16"	3/8"	Bare	0.64 lbs.	50



Continuous Fence Clips - Round Ends

Item #	Size (O.D.)	Gauge	Hole	Finish	Wt. lbs.	Qty.
#49135	1-1/4"	10	1/4"	Bare	0.18 lbs.	200
#50619	1-1/4"	10	3/8"	Bare	0.17 lbs.	200



FARM AND RANCH FENCE CLIPS / PANEL CONNECTORS

Continuous Fence Clips - Square

Item #	Size (SQ)	Gauge	Hole	Finish	Wt. lbs.	Qty.
#50222	1"	12	3/8"	Bare	0.23 lbs.	100
#50223	1-1/4"	12	3/8"	Bare	0.28 lbs.	100
#50224	1-1/2"	12	3/8"	Bare	0.29 lbs.	100



Lag Bolts For Continuous Fence Clips

Item #	Size (Diameter x Length)	Finish	Wt. lbs.	Qty.
#50353	5/16" x 2-1/2"	Zinc	0.04 lbs.	50
#50354	5/16" x 3"	Zinc	0.01 lbs.	50
#50350	3/8" x 2"	Zinc	0.04 lbs.	50
#50351	3/8" x 2-1/2"	Zinc	0.06 lbs.	50
#50352	3/8" x 3"	Zinc	0.10 lbs.	50

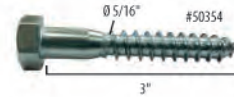

Chute Springs

Item #	Style	Finish	Wt. lbs.	Qty.
#49786	Left	Bare	0.05 lbs.	1
#49787	Right	Bare	0.05 lbs.	1



Chute Springs

Item #	Size (Length x Diameter)	Finish	Wt. lbs.	Qty.
#50136	(A) 12" x 1"	Bare	0.65 lbs.	1
#50137	(B) 4-3/8" x 3/4"	Bare	0.06 lbs.	1



Replacement Pin

Item #	Type	Finish	Wt. lbs.	Qty.
#49742	Pin with Chain	Powder Coat	1.45 lbs.	20



Pipe Clamp With Clevis

Item #	Accommodates Pipe	Finish	Wt. lbs.	Qty.
#49744	2-3/4"	Powder Coat	2.10 lbs.	10



Single Clevis

Item #	Style	Finish	Wt. lbs.	Qty.
#49748	Single	Powder Coat	0.45 lbs.	20





Fence Connectors

Item #	Size (Fits Inside)	Accommodates Gauges	O.D.	Thickness	Finish	Wt. lbs.	Qty.
#50108	1.25"	16ga, 14ga, 12ga	1.05"	14ga	Bare	0.43 lbs.	60
#50109	1.5" and 1.66"	14ga	1.315"	13ga	Bare	0.75 lbs.	50
#80142	1.25"	16ga, 14ga, 12ga	1.05"	13ga	Bare	0.49 lbs.	60



Fence Connectors - Pressed

New

Item #	Size (Fits Inside)	Accommodates Gauges	O.D.	Thickness	Finish	Wt. lbs.	Qty.
#80274	1.25"	16ga, 14ga, 12ga	1.05"	16ga	Bare	0.31 lbs.	60
#81073	1.50"	14ga	1.25"	16ga	Bare	0.39 lbs.	60
#80275	1.66"	16ga, 14ga, 12ga	1.375"	16ga	Bare	0.43 lbs.	60

Pressed Elbow - 90°

Item #	Pipe Size	O.D.	Finish	Wt. lbs.	Qty.
#49488	1-1/4"	1.66"	Bare	0.53 lbs.	60 / box 1,400 / drum



Ornamental Schedule 40 Steel Tees

Item #	Pipe Size	O.D.	Finish	Wt. lbs.	Qty.
#48040	1"	1-5/16"	Painted	0.37 lbs.	50
#48041	1-1/4"	1-5/8"	Painted	0.65 lbs.	12
#48042	1-1/2"	1-7/8"	Painted	0.92 lbs.	12
#48043	2"	2-3/8"	Painted	1.49 lbs.	8
#48044	2-1/2"	2-7/8"	Painted	2.68 lbs.	6



Ornamental Schedule 40 Elbows

Item #	Pipe Size	Degree	O.D.	Center Line Radius	Inside Radius	Finish	Wt. lbs.	Qty.
#47957	1-1/4"	45°	1-5/8"	1.9"	1.12"	Painted	0.28 lbs.	40
#47958	1-1/2"	45°	1-7/8"	2.25"	1.35"	Painted	0.40 lbs.	40
#47040	1/2"	90°	7/8"	1.5"	1"	Painted	0.18 lbs.	50
#47041	3/4"	90°	1-1/16"	1.1"	.60"	Painted	0.22 lbs.	50
#47042	1"	90°	1-5/16"	1.5"	.80"	Painted	0.33 lbs.	30
#47043	1-1/4"	90°	1-5/8"	1.9"	1.1"	Painted	0.55 lbs.	30
#47044	1-1/2"	90°	1-7/8"	2.25"	1.35"	Painted	0.79 lbs.	20
#47045	2"	90°	2-3/8"	3"	1.8"	Painted	1.43 lbs.	20
#47046	2-1/2"	90°	2-7/8"	3.75"	2.3"	Painted	2.84 lbs.	10
#47047	3"	90°	3-1/2"	4.5"	2.75"	Painted	4.47 lbs.	5
#47048	4"	90°	4-1/2"	6"	3.75"	Painted	8.47 lbs.	1
#47049	6"	90°	6-5/8"	9"	5.7"	Painted	22.20 lbs.	1



Dome Post Caps

Item #	Cap Size	Thickness	Finish	Wt. lbs.	Qty.
#45938	1-5/8" OD	12ga	Bare	0.14 lbs.	200 / box
#45940	1-7/8" OD	12ga	Bare	0.14 lbs.	200 / box
#45942 #45943	2-3/8" OD	12ga	Bare	0.25 lbs.	100 / box 3,400 / drum
#45944 #45945	2-7/8" OD	12ga	Bare	0.33 lbs.	100 / box 1,900 / drum
#45946 #45947	3-1/2" OD	12ga	Bare	0.40 lbs.	100 / box 1,500 / drum
#46450 #46451	4" OD	12ga	Bare	0.49 lbs.	50 / box 1,250 / drum
#45948 #45949	4-1/2" OD	12ga	Bare	0.66 lbs.	50 / box 1,200 / drum
#46452	5" OD	12ga	Bare	0.82 lbs.	40 / box
#45950 #45951	5-1/2" OD	12ga	Bare	0.99 lbs.	20 / box 550 / drum
#45952	6-5/8" OD	12ga	Bare	1.25 lbs.	20 / box
#49218	8-5/8" OD	11ga	Bare	2.06 lbs.	10 / box



Low Profile Post Caps

Item #	Cap Size	Thickness	Finish	Wt. lbs.	Qty.
#49445	1-5/8" OD	12ga	Bare	0.10 lbs.	400
#47605	1-7/8" OD	12ga	Bare	0.12 lbs.	400
#47606	2-3/8" OD	12ga	Bare	0.14 lbs.	261
#47607	2-7/8" OD	12ga	Bare	0.17 lbs.	180
#47608	3-1/2" OD	12ga	Bare	0.21 lbs.	114
#47609	4-1/2" OD	12ga	Bare	0.51 lbs.	72



(Caps Are Stacked)

Flat Disc Post Caps

Item #	Cap Size	Thickness	Finish	Wt. lbs.	Qty.
#49444	1-5/8" OD	12ga	Bare	0.10 lbs.	420
#47595	1-7/8" OD	12ga	Bare	0.12 lbs.	420
#47596	2-3/8" OD	12ga	Bare	0.14 lbs.	270
#47597	2-7/8" OD	12ga	Bare	0.17 lbs.	180
#47598	3-1/2" OD	12ga	Bare	0.21 lbs.	120
#47599	4-1/2" OD	12ga	Bare	0.51 lbs.	72



(Caps Are Stacked)

Small Diameter Flat Post Caps

Item #	Fits Post Size (inside)	Thickness	Finish	Wt. lbs.	Qty.
#80245	1-1/2" OD	10ga	Bare	0.05 lbs.	50
#80158	1-7/8" OD	12ga	Bare	0.07 lbs.	50
#80159	2-3/8" OD	12ga	Bare	0.13 lbs.	100
#80160	2-7/8" OD	12ga	Bare	0.17 lbs.	100
#80161	3-1/2" OD	10ga	Bare	0.27 lbs.	100
#80162	4-1/2" OD	10ga	Bare	0.49 lbs.	50
#80163	6-5/8" OD	10ga	Bare	0.95 lbs.	50



(Caps Are Stacked)

Square Flat Post Caps

Item #	Fits Post Size	Thickness	Finish	Wt. lbs.	Qty.
#80166	1-1/2"	11ga	Bare	0.06 lbs.	50
#80167	2"	11ga	Bare	0.11 lbs.	50
#80168	2-1/2"	12ga	Bare	0.17 lbs.	50
#80169	3"	12ga	Bare	0.25 lbs.	50
#80170	3-1/2"	11ga	Bare	0.39 lbs.	50
#80171	4"	11ga	Bare	0.51 lbs.	50
#80172	6"	12ga	Bare	1.04 lbs.	20

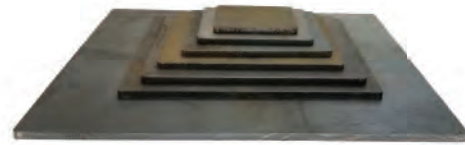

(Caps Are Stacked)

Rectangular Flat Post Caps

Item #	Fits Post Size	Thickness	Finish	Wt. lbs.	Qty.
#80173	2" x 1"	12ga	Bare	0.06 lbs.	50
#80246	3" x 1"	11ga	Bare	0.12 lbs.	50
#80174	3" x 1-1/2"	12ga	Bare	0.11 lbs.	50
#80247	3" x 2"	11ga	Bare	0.18 lbs.	50
#80175	4" x 2"	12ga	Bare	0.25 lbs.	50
#80176	6" x 2"	11ga	Bare	0.34 lbs.	50



(Caps Are Stacked)

Steel Pressed Post Caps

Item #	Size (Fits Over Square)	Height	Finish	Wt. lbs.	Qty.
#O0040	1"	3/8"	Bare	0.01 lbs.	20
#O0029	1-1/2"	5/8"	Bare	0.03 lbs.	20
#O0030	2"	1"	Bare	0.07 lbs.	20
#O0031	3"	1-1/16"	Bare	0.13 lbs.	30
#O0027	4"	1-5/8"	Bare	0.31 lbs.	15

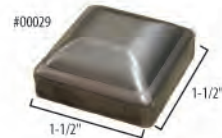

Cast Iron Pyramid Post Caps

Item #	Size (Fits Over Square)	Height	Finish	Wt. lbs.	Qty.
#O0021	1"	3/4"	Bare	0.12 lbs.	250
#O0108	1-1/4"	1-1/2"	Bare	0.18 lbs.	40
#O0022	1-1/2"	1-1/8"	Bare	0.23 lbs.	120
#O0023	2"	1-1/8"	Bare	0.47 lbs.	100
#O0024	2-1/2"	1-3/8"	Bare	0.58 lbs.	40
#O0025	3"	1-3/8"	Bare	0.89 lbs.	40
#O0026	4"	1-1/2"	Bare	1.50 lbs.	25
#O0039	6"	1-3/4"	Bare	2.90 lbs.	9

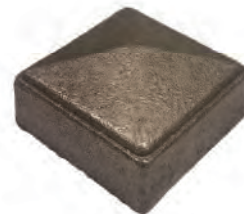

Cast Iron Post Balls

Item #	Size (Fits Over Square)	Height	Ball Diameter	Finish	Wt. lbs.	Qty.
#O0106	1"	2-7/16"	1-1/8"	Bare	0.42 lbs.	25
#O0107	1-1/4"	2-1/2"	1-1/8"	Bare	0.66 lbs.	60
#O0015	1-1/2"	3-1/8"	1-3/8"	Bare	0.89 lbs.	32
#O0016	2"	3-3/4"	1-3/4"	Bare	1.50 lbs.	25
#O0017	2-1/2"	4-3/8"	2"	Bare	2.76 lbs.	15
#O0018	3"	5"	2-1/2"	Bare	2.08 lbs.	12
#O0019	4"	5-1/2"	3"	Bare	4.06 lbs.	10
#O0020	6"	7"	4"	Bare	10.38 lbs.	2



Pressed Post Caps

Item #	Size (Fits Over)	Height	Finish	Wt. lbs.	Qty.
#80625	1.90"	1-1/2"	Bare	0.19 lbs.	50
#80267	2-3/8"	1-9/16"	Bare	0.27 lbs.	50
#80268	2-7/8"	1-5/8"	Bare	0.34 lbs.	50
#80269	3-1/2"	1-15/16"	Bare	0.53 lbs.	50
#80270	4-1/2"	2-9/16"	Bare	0.81 lbs.	50



Pressed Post Caps

Item #	Size (Fits Over)	Height	Finish	Wt. lbs.	Qty.
#50279	2-3/8"	1-7/16"	HDG	0.27 lbs.	50
#50280	2-7/8"	1-1/2"	HDG	0.35 lbs.	50
#50281	3-1/2"	1-1/2"	HDG	0.49 lbs.	50
#50390	4-1/2"	1-3/4"	HDG	0.81 lbs.	50



Welded Post Caps

Item #	Size (Fits Over)	Height	Finish	Wt. lbs.	Qty.
#80775	1-1/2"	3/8"	Bare	0.05 lbs.	50
#80776	1-3/4"	3/8"	Bare	0.09 lbs.	50
#80778	1-3/4"	3/8"	Galv	0.06 lbs.	50
#80777	2"	5/16"	Bare	0.08 lbs.	50



Square

Plastic Plugs

Item #	Size (Fits Inside)	Gauge	Wt. lbs.	Qty.
#48059	1/2"	16ga	0.01 lbs.	100
#50077	3/4"	16ga, 14ga	0.01 lbs.	200
#50078	5/8"	16ga, 14ga	0.01 lbs.	300
#50079	1"	14ga	0.01 lbs.	100
#50080	1-1/4"	14ga, 11ga	0.01 lbs.	100
#50081	1-1/2"	16ga, 14ga, 11ga	0.01 lbs.	100
#80443	1-3/4"	20ga - 14ga	0.01 lbs.	500
#50082	2"	14ga, 11ga	0.03 lbs.	50
#48405	3"	14ga	0.04 lbs.	200
#48361	4"	3/16", 1/4"	0.22 lbs.	100



Rectangular

Item #	Size (Fits Inside)	Gauge	Wt. lbs.	Qty.
#50083	2" x 1"	14ga, 11ga	0.02 lbs.	100
#80444	4" x 2"	14ga, 11ga	0.04 lbs.	250



Round

Item #	Size (Fits Inside)	Gauge	Wt. lbs.	Qty.
#50162	1"	14ga, 11ga	0.01 lbs.	100
#50163	1-1/4"	14ga, 11ga	0.01 lbs.	100
#50164	1-1/2"	14ga, 11ga	0.01 lbs.	100
#80442	1-3/4"	20ga - 14ga	0.01 lbs.	1,000
#50165	2"	14ga, 11ga	0.03 lbs.	50



Plastic Pyramid Caps

Item #	Size (Fits Over)	Height	Wt. lbs.	Qty.
#50440	1-1/2"	1"	0.01 lbs.	100
#50441	2"	1-1/4"	0.01 lbs.	48
#50442	3"	1-1/2"	0.10 lbs.	20



1/2" Square Tubing Rings

Item #	O.D.	Finish	Wt. lbs.	Qty.
#O0169	3-1/4"	Bare	0.18 lbs.	1
#O0170	3-1/2"	Bare	0.20 lbs.	200
#O0171	4"	Bare	0.21 lbs.	150
#O0172	4-1/2"	Bare	0.23 lbs.	200
#O0173	5"	Bare	0.28 lbs.	150
#O0182	6"	Bare	0.32 lbs.	150
#O0183	8"	Bare	0.45 lbs.	80



Steel Lock Boxes With Guard

Item #	Size (Width x Height)	Type	Depth	Backset	Opening	Finish	Wt. lbs.	Qty.
#49452	3-1/2" x 3-1/2"	Single	1-1/4"	2-3/8"	2-1/8"	Bare	0.91 lbs.	10
#49495	4-1/4" x 3-3/8"	Single	1-1/2"	2-3/8"	2-1/8"	Bare	0.90 lbs.	10
#49451	4-1/4" x 4-1/2"	Single	1"	2-3/8"	2-1/8"	Bare	0.93 lbs.	10
Item #	Size (Width x Height)	Type	Depth	Backset	Opening	Finish	Wt. lbs.	Qty.
#49454	4-1/2" x 6-3/4"	Double	1-1/4"	2-3/8"	2-1/8"	Bare	1.63 lbs.	10
#49496	4-1/4" x 6-7/8"	Double	1-1/2"	2-3/8"	2-1/8"	Bare	1.50 lbs.	10
#49453	4-1/2" x 7-1/2"	Double	1"	2-3/8"	2-1/8"	Bare	1.59 lbs.	40



Single



Double

Pipe Panel Pals

This product was proudly developed inhouse to simplify fence building. There are a wide range of size options that allow for the use of different pipe diameters for your vertical and horizontal pipes.



Standard*

Item #	Size (Fits Over)	Holds	Thickness	Finish	Wt. lbs.	Qty.
#80001	1-1/4"	1-1/4"	11ga	Bare	0.15 lbs.	50
#80002	1-5/8"	1-5/8"	11ga	Bare	0.28 lbs.	50
#80003	1-7/8"	1-7/8"	11ga	Bare	0.32 lbs.	50
#80004	2"	2"	11ga	Bare	0.37 lbs.	100
#80005	2-3/8"	2-3/8"	11ga	Bare	0.45 lbs.	50
#80136		2-7/8"	10ga	Bare	0.56 lbs.	50
#80137		3-1/2"	10ga	Bare	0.58 lbs.	50
#80139		4-1/2"	8ga	Bare	0.71 lbs.	50
#80006	2-7/8"	2-7/8"	11ga	Bare	0.67 lbs.	25
#80138		3-1/2"	11ga	Bare	0.67 lbs.	50
#80140		4-1/2"	9ga	Bare	0.85 lbs.	50
#80007	3"	3"	10ga	Bare	0.70 lbs.	50
#80008	3-1/2"	3-1/2"	10ga	Bare	0.85 lbs.	25
#80009	4"	4"	10ga	Bare	1.10 lbs.	25
#80010	4-1/2"	4-1/2"	9ga	Bare	1.44 lbs.	25

- Made of carbon steel for easy welding
- Much cheaper than cast steel
- Resists cracking associated with similar cast iron products
- Preformed saddle fits perfectly every time saving hours of cutting and welding labor
- *The 90 degree end slips over standard size pipes of any wall thickness and the saddle is shaped to fit perfectly against the mating pipe forming a perfect Tee every time.
- *Pipe can be left unwelded at one end to allow for expansion and contraction in extreme weather over long distances
- *Pipe can be left unwelded at both ends allowing the horizontal pipe to act as a hinge over waterways
- *Slot can be turned down to allow for drainage
- *Horizontal pipes don't have to be cut accurately as the saddles allow for a large tolerance on the length

Transitional Cap

Item #	Size (Mates To)	Holds	Thickness	Finish	Wt. lbs.	Qty.
#80363	2-7/8"	2-3/8"	11ga	Bare	0.22 lbs.	100



Cast Iron Baluster Collars

Item #	Type	Fits Over Square	Base	Height	Finish	Wt. lbs.	Qty.
#00028	(A) Square	1/2"	1-1/2"	1-3/4"	Bare	0.31 lbs.	120
#00181	(B) Square Plain	5/8"	1-9/16"	1-3/4"	Bare	0.44 lbs.	100
#00036	(B) Square Plain	3/4"	1-3/4"	1-13/16"	Bare	0.37 lbs.	70



↔ Width ↑ Height

Cast Iron Finials And Spears

Item #	Cast Iron Finial Type	Fits Over Square	Base	Width	Height	Finish	Wt. lbs.	Qty.
#00003	(A) Banana Peel	1/2"	1"	2-1/4"	3-3/8"	Bare	0.30 lbs.	50
#00009	(A) Banana Peel	3/4"	1-1/4"	2-1/2"	4"	Bare	0.40 lbs.	50
#00004	(B) Triad	1/2"	1"	2"	4-1/4"	Bare	0.31 lbs.	100
#00010	(B) Triad	3/4"	1-1/4"	1-7/8"	3-7/8"	Bare	0.28 lbs.	100
#00086	(C) Umbrella	3/4"	1-1/4"	3-3/4"	5-3/4"	Bare	0.66 lbs.	50
#00007	(D) Pineapple	1/2"	1"	1"	1-1/8"	Bare	0.31 lbs.	150
#00014	(D) Pineapple	3/4"	1-1/4"	1-1/4"	2-3/8"	Bare	0.44 lbs.	100
#00088	(E) Spear, Open Body	1/2"	7/8"	1-1/2"	3-5/8"	Bare	0.29 lbs.	120
#00082	(F) Roman w/ Octagon Base	3/4"	1-1/4"	2-3/4"	6"	Bare	0.79 lbs.	50
#00105	(G) Square Pyramid	3/4"	1-1/2"	1-3/4"	5"	Bare	1.06 lbs.	40
#00083	(H) Arrow Square	1/2"	1"	3"	6"	Bare	0.53 lbs.	70
#00104	(I) Roman Square Base	1/2"	1"	2-1/8"	4-1/4"	Bare	0.35 lbs.	100
#00077	(J) Spear	3/4"	1-1/8"	2-5/8"	5-1/2"	Bare	0.70 lbs.	50



←→ Width ↑↓ Height

Cast Iron Finials And Spears

Item #	Cast Iron Finial Type	Fits Over Square	Base	Width	Height	Finish	Wt. lbs.	Qty.
#O0001	(A) Quad with Ball	1/2"	1"	1"	4"	Bare	0.28 lbs.	120
#O0008	(A) Quad with Ball	3/4"	1-1/8"	1-1/8"	4-1/8"	Bare	0.30 lbs.	100
#O0002	(B) Quad-No Ball	1/2"	1"	1"	4"	Bare	0.22 lbs.	120
#O0011	(B) Quad-No Ball	3/4"	1-1/8"	1-1/8"	4-1/4"	Bare	0.30 lbs.	50
#O0075	(C) Sloped Quad	1/2"	3/4"	7/8"	3-3/4"	Bare	0.32 lbs.	120
#O0102	(D) Wide Quad with Ball	3/4"	1-1/4"	1-7/8"	5-3/4"	Bare	0.93 lbs.	30
#O0005	(E) Boy Scout	1/2"	1"	2-5/8"	4-1/2"	Bare	0.33 lbs.	100
#O0012	(E) Boy Scout	3/4"	1-1/8"	2-3/4"	4-3/4"	Bare	0.43 lbs.	80
#O0079	(F) Rounded Boy Scout	1/2"	7/8"	3"	4-3/4"	Bare	0.39 lbs.	100
#O0080	(F) Rounded Boy Scout	3/4"	3"	3"	5"	Bare	0.50 lbs.	60
#O0087	(G) Lyre	1/2"	Ø 1-1/8"	2-3/8"	5-1/2"	Bare	0.68 lbs.	60
#O0093	(H) Slotted Cross	3/4"	1-1/4"	3-1/4"	6-1/8"	Bare	1.00 lbs.	40
#O0098	(I) Traditional	1/2"	1-1/8"	3-1/4"	5-1/4"	Bare	0.68 lbs.	50
#O0099	(I) Traditional	3/4"	1-1/8"	3-1/4"	5-1/4"	Bare	0.77 lbs.	50
#O0006	(J) Fleur-de-lis	1/2"	1-1/8"	3"	4-1/2"	Bare	0.45 lbs.	80
#O0013	(J) Fleur-de-lis	3/4"	1-1/8"	3"	4-3/4"	Bare	0.51 lbs.	80
#O0076	(K) Fleur-de-lis No Ball	1/2"	1"	2-1/4"	4"	Bare	0.45 lbs.	100

WELDING WELDING HELMETS / ACCESSORIES

Auto-Darkening Welding Helmets

Item #	Type	Wt. lbs.	Qty.
#49965	Black	2.50 lbs.	4
#49966	Skull and Flames	2.50 lbs.	4
#49967	Spider	2.50 lbs.	4
#49968	Flag	2.50 lbs.	4
#50105	Camo	2.50 lbs.	4
#70254	Red/Black	2.50 lbs.	4



Auto-Darkening Welding Helmets - Wide View

Item #	Type	Wt. lbs.	Qty.
<i>New</i> #70281	Black	2.50 lbs.	4
<i>New</i> #70282	Red/Silver	2.50 lbs.	4



Welding Helmet Replacement Headgear And Sweatband

Item #	Type	Fits Style	Wt. lbs.	Qty.
#50107	Headgear and Sweatband	Standard	0.34 lbs.	50
#50191	Sweatband	Standard	0.09 lbs.	5
<i>New</i> #70284	Headgear and Sweatband	Wide View	0.34 lbs.	50



Welding Helmet Replacement Lens

Item #	Size (Length x Width)	Fits Style	Wt. lbs.	Qty.
#70044	4" x 1-7/8"	All Styles (Inside)	0.10 lbs.	200
#50106	4-5/16" x 3-1/2"	#49965 & #49967 (Outside)	0.15 lbs.	100
#70252	4-5/8" x 3-3/4"	#49966, #49968 & #50105, #70254 (Outside)	0.17 lbs.	100
<i>New</i> #70279	5-7/16" x 4-13/16"	Wide View	0.25 lbs.	100



Welding Beanie/Cap

Item #	Type	Wt. lbs.	Qty.
#70255	Navy	0.08 lbs.	10



Welding Helmet Shades - #10

Item #	Size (Width x Length)	Wt. lbs.	Qty.
#70043	2" x 4-1/4"	0.10 lbs.	5
#70045	4-1/2" x 5-1/4"	0.35 lbs.	5



Armour Guard-SEER Shades

Item #	Size (Width x Length)	Fixed Shade	Wt. lbs.	Qty.
#80187	2" x 4-1/4"	9	0.14 lbs.	1
#80188	2" x 4-1/4"	10	0.14 lbs.	1
#80189	2" x 4-1/4"	11	0.14 lbs.	1



WG-209-51 Safety Goggles

Item #	Wt. lbs.	Qty.
#70047	0.46 lbs.	10



Lightweight Safety Glasses

Item #	Wt. lbs.	Qty.
#70190	0.07 lbs.	6



Locking "C" Clamps

Item #	Size	Swivel	Wt. lbs.	Qty.
#70055	6"	No	1.62 lbs.	6
#80327	6"	Yes	0.62 lbs.	1



Adjustable - "C" Clamps

Item #	Size	Wt. lbs.	Qty.
#49862	6"	2.37 lbs.	1
#80326	8"	3.75 lbs.	1



Mig Welding Pliers

Item #	Wt. lbs.	Qty.
#70026	0.64 lbs.	4



Multi-Purpose Welding Magnets

Item #	Size	Wt. lbs.	Qty.
#70226	Small - 3"	0.38 lbs.	6
#70056	Medium - 4-1/2"	0.75 lbs.	10
#70193	Large - 6"	1.65 lbs.	6
#70194	Extra Large - 7-1/2"	2.75 lbs.	20

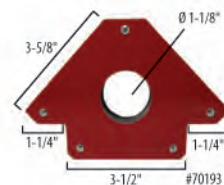

WELDING ACCESSORIES

Cable Connectors

Item #	Type	Wt. lbs.	Qty.
#70160	300 AMP	0.63 lbs.	50
#70161	500 AMP	0.75 lbs.	35



Welding Electrode Holders

Item #	Type	Wt. lbs.	Qty.
#70163	300 AMP	0.71 lbs.	50
#70211	600 AMP	1.10 lbs.	30



Ground Clamp - Brass Alloy

Item #	Type	Wt. lbs.	Qty.
#70173	500 AMP	1.30 lbs.	12



Steel Ground Clamps Heavy-Duty

Item #	Type	Wt. lbs.	Qty.
#70174	300 AMP	0.49 lbs.	50
#70175	500 AMP	1.00 lbs.	30



4" Magnet Ground Clamp

Item #	Type	Wt. lbs.	Qty.
#70247	500 AMP	1.13 lbs.	18



Single Flint Strikers

Item #	Type	Wt. lbs.	Qty.
#70030	Striker	0.15 lbs.	10
#70031	Renewal (5/pk)	0.01 lbs.	10
#70187	Striker and Renewal (5/pk)	0.20 lbs.	10



Tri-Flint Strikers

Item #	Type	Wt. lbs.	Qty.
#70032	Striker	0.22 lbs.	25
#70188	Renewal	0.01 lbs.	10



Flat Soapstones And Holder

Item #	Type	Wt. lbs.	Qty.
#70024	Holder with Soapstone	0.13 lbs.	12
#70025	Replacement Soapstones (6/pk)	0.33 lbs.	100
#70199	Replacement Soapstones (144/pk)	6.65 lbs.	12



Round Soapstones And Holder

Item #	Type	Wt. lbs.	Qty.
#70196	Holder with Soapstone	0.08 lbs.	10
#70195	Replacement Soapstones (6/pk)	0.17 lbs.	12
#70200	Replacement Soapstones (144/pk)	3.70 lbs.	12



8" Wire Brushes - Toothbrush

Item #	Type	Row Pattern	Wt. lbs.	Qty.
#70034	Stainless Steel	3 x 7	0.04 lbs.	12
#70036	Brass	3 x 7	0.04 lbs.	12



8-5/8" Wire Brushes - Curved

Item #	Type	Row Pattern	Wt. lbs.	Qty.
#70035	Stainless Steel	2 x 9	0.08 lbs.	12
#70037	Brass	2 x 9	0.08 lbs.	12



10" Shoe Handle Wire Brush

Item #	Type	Row Pattern	Wt. lbs.	Qty.
#70039	Carbon	4 x 16	0.29 lbs.	12



13" Wooden Handle Angled Wire Brush

Item #	Type	Row Pattern	Wt. lbs.	Qty.
#70272	Carbon	3 x 14	0.38 lbs.	12



14" Wooden Handle Wire Brushes

Item #	Type	Row Pattern	Wt. lbs.	Qty.
#70038	Carbon	3 x 19	0.33 lbs.	15
#70040	Stainless Steel	3 x 19	0.25 lbs.	12



Chipping Hammers

Item #	Style	Finish	Wt. lbs.	Qty.
#70162	Cross Chisel	Powder Coat	1.10 lbs.	10
#70022	Hatchet	Powder Coat	0.86 lbs.	10
#70246	Hatchet with Brush	Powder Coat	1.46 lbs.	10



Universal Tank Wrench

Item #	Finish	Wt. lbs.	Qty.
#70023	Powder Coat	0.72 lbs.	5



Standard Tip Cleaner Set

Item #	Finish	Wt. lbs.	Qty.
#70033	Stainless Steel	0.03 lbs.	12



Victor® Style Cutting Tips

Oxy-Acetylene

Item #	Type	Wt. lbs.
#70228	1-101-000 Victor® Style Cutting Tip	0.13 lbs.
#70229	1-101-00 Victor® Style Cutting Tip	0.07 lbs.
#70227	1-101-0 Victor® Style Cutting Tip	0.07 lbs.
#70059	1-101-1 Victor® Style Cutting Tip	0.20 lbs.
#70060	1-101-2 Victor® Style Cutting Tip	0.19 lbs.
#70230	1-101-3 Victor® Style Cutting Tip	0.19 lbs.
#70231	3-101-000 Victor® Style Cutting Tip	0.13 lbs.
#70184	3-101-00 Victor® Style Cutting Tip	0.07 lbs.
#70057	3-101-0 Victor® Style Cutting Tip	0.13 lbs.
#70058	3-101-1 Victor® Style Cutting Tip	0.07 lbs.
#70185	3-101-2 Victor® Style Cutting Tip	0.19 lbs.
#70186	3-101-3 Victor® Style Cutting Tip	0.19 lbs.



Natural Gas or Propane

Item #	Type	Wt. lbs.
#70234	GPN-000 Victor® Style Cutting Tip	0.13 lbs.
#70235	GPN-00 Victor® Style Cutting Tip	0.13 lbs.
#70232	GPN-0 Victor® Style Cutting Tip	0.13 lbs.
#70233	GPN-1 Victor® Style Cutting Tip	0.19 lbs.
#70236	GPN-2 Victor® Style Cutting Tip	0.19 lbs.
#70237	GPN-3 Victor® Style Cutting Tip	0.19 lbs.
#70238	GPN-4 Victor® Style Cutting Tip	0.19 lbs.
#70239	3GPN-00 Victor® Style Cutting Tip	0.13 lbs.
#70240	3GPN-0 Victor® Style Cutting Tip	0.13 lbs.
#70241	3GPN-1 Victor® Style Cutting Tip	0.19 lbs.
#70242	3GPN-2 Victor® Style Cutting Tip	0.19 lbs.
#70243	3GPN-3 Victor® Style Cutting Tip	0.19 lbs.
#70244	3GPN-4 Victor® Style Cutting Tip	0.19 lbs.



Gas Couplers

Item #	Gas Type	Size	Wt. lbs.	Qty.
#80375	Oxygen	30	0.06 lbs.	1
#80376	Acetylene	31	0.06 lbs.	1



TECHNIWELDUSA

Quick-Connects Set

Item #	Style	Wt. lbs.	Qty.
#80377	Torch to Hose	7.97 lbs.	1
#80378	Regulator to Hose	11.57 lbs.	1



TECHNIWELDUSA

Flashback Arrestor Set

Item #	Wt. lbs.	Qty.
#70183	0.61 lbs.	48



5/8" Bore Tweco® Style With Mig Nozzle

Item #	Fits Welders	Wt. lbs.	Qty.
#70053	125 / 135 / 175	0.17 lbs.	12



Contact Tips - 5/Pack

Item #	Style	Wt. lbs.	Qty.
#70050	.025"	0.08 lbs.	12
#70051	.030"	0.08 lbs.	12
#70052	.035"	0.08 lbs.	20



Twin Welding Oxygen - Acetylene Hose

Item #	Size	Wt. lbs.	Qty.
#80374	3/16" x 50'	7.97 lbs.	1 *
#70063	1/4" x 25'	5.50 lbs.	4
<i>New</i> #70280	1/4" x 50'	12.02 lbs.	1
<i>New</i> #80373	1/4" x 50'	11.57 lbs.	1 *
#81064	1/4" x 100'	23.70 lbs.	1 *



TECHNIWELDUSA

21" Victor® Style Hand Cutting Torch

Item #	Wt. lbs.	Qty.
#70256	3.56 lbs.	1



Cutting Attachment

Item #	Style	Length	Wt. lbs.	Qty.
#70267	Medium-duty	8"	1.00 lbs.	1
#70268	Heavy-duty Series 1	10-1/2"	2.09 lbs.	1



Torch Handle Attachments

Item #	Style	Length	Wt. lbs.	Qty.
#70269	Light/Medium-Duty	9"	1.06 lbs.	1
#70270	Medium/Heavy-Duty	9-1/2"	1.50 lbs.	1



Acetylene Regulators

Item #	Style	Wt. lbs.	Qty.
#70258	(A) 250 Series	2.86 lbs.	1
#70260	(B) 350 Series	2.20 lbs.	1
#70264	(C) 450 Series	3.30 lbs.	1

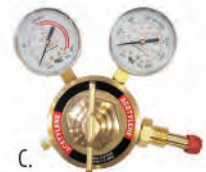
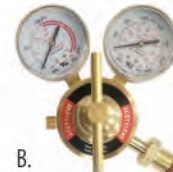
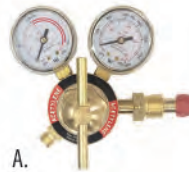

Nitrogen Regulator

Item #	Style	Wt. lbs.	Qty.
#70262	350 Series	2.20 lbs.	1



Oxygen Regulators

Item #	Style	Wt. lbs.	Qty.
#70259	(A) 250 Series	2.86 lbs.	1
#70261	(B) 350 Series	2.20 lbs.	1
#70265	(C) 450 Series	3.30 lbs.	1

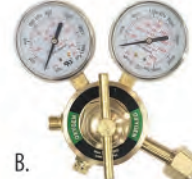

Flow-Meter Regulator

Item #	Wt. lbs.	Qty.
#70257	1.98 lbs.	1



Propane Gas Torch

Item #	Wt. lbs.	Qty.
#50146	3.00 lbs.	10

PROPANE TANK NOT INCLUDED



Weed Burner Kit

Item #	Wt. lbs.	Qty.
#70271	3.56 lbs.	1

PROPANE TANK NOT INCLUDED



Torch Outfit Kits

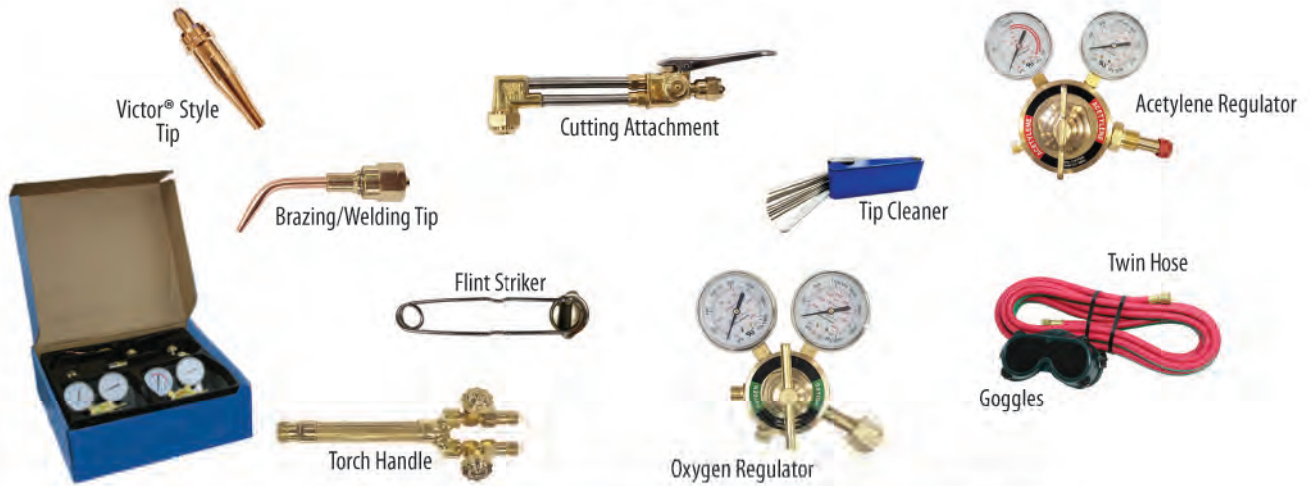

Item #	Style	Includes	Wt. lbs.	Qty.
#70263	350 Series	<ul style="list-style-type: none"> • 12' x 1/4" R-Grade Twin Hose • Standard Goggles • Standard Tip Cleaner • Medium Cutting Attachment • Victor Style Brazing/Welding Assembly W#2 • 0-1-101 Size 1 Victor Style Acetylene Cutting Tip • Flint Striker • Medium-duty Torch Handle • 350 Series Acetylene Regulator CGA-510 • 350 Series Oxygen Regulator CGA-540 	16.19 lbs.	1
#70266	450 Series	<ul style="list-style-type: none"> • 12' x 1/4" R-Grade Twin Hose • Standard Goggles • Standard Tip Cleaner • Medium Cutting Attachment • Victor Style Brazing/Welding Assembly W#2 • 0-1-101 Size 1 Victor Style Acetylene Cutting Tip • Flint Striker • Medium-duty Torch Handle • 450 Series Acetylene Regulator CGA-510 • 450 Series Oxygen Regulator CGA-540 	22.00 lbs.	1



We are proud to offer a full line of abrasive and welding supplies. We can customize any 4', 8', or 12' display to suit your showroom.

Contact a sales representative for more details.

Total Cut®

Pipe Guides

"Precision Cutting Made Simple"

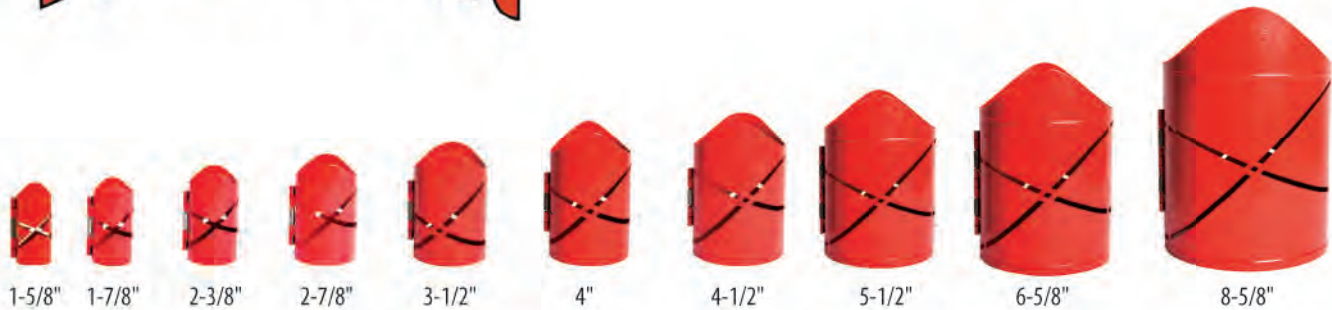

A Fabricators Best Friend!

Clamps onto pipe with heavy-duty spring, allowing you to mark precisely.
No magnets to collect metal shavings in your tool box. It doesn't get any easier!

Item #	Size	Finish	Wt. lbs.	QTY (Pieces per case)
#47937	1-5/8"	Powder Coat	0.37 lbs.	12
#47022	1-7/8"	Powder Coat	0.40 lbs.	12
#47023	2-3/8"	Powder Coat	0.55 lbs.	12
#47024	2-7/8"	Powder Coat	0.71 lbs.	12
#47025	3-1/2"	Powder Coat	0.85 lbs.	6
#47716	4"	Powder Coat	1.40 lbs.	6
#47026	4-1/2"	Powder Coat	1.38 lbs.	6
#50131	5-1/2"	Powder Coat	2.25 lbs.	6
#47717	6-5/8"	Powder Coat	3.13 lbs.	6
#47718	8-5/8"	Powder Coat	5.75 lbs.	6

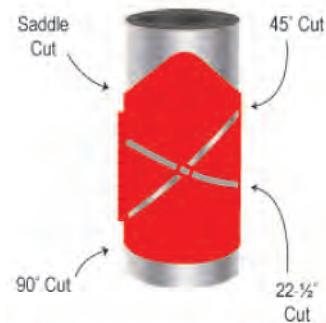

Coming in 2023!

Pipe Guide Kit: 1-7/8", 2-3/8", and 2-7/8"

Saddle Series Cutting Guide

Item #	Size	Finish	Wt. lbs.	Qty.
#70275	2-3/8"	Powder Coat	0.38 lbs.	12

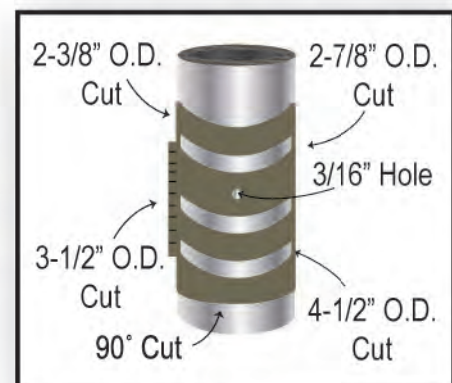

Welding Rods

E6010 Arc Welding Rods

- All position electrode
- Carbon and galvanized steel
- DC Welder and DCEP

E6011 Arc Welding Rods

- All purpose, all position
- Great on rusty, dirty metal, and poor fit ups
- Designed for repair and maintenance
- Suits AC or DC Machines

E6013 Arc Welding Rods

- Mild steel, all purpose, all position electrode
- Best on clean, new metal
- Easy start at low amperage
- Suits AC or DC Machines

E7018 Arc Welding Rods

- Low hydrogen
- Cold rolled steel, high carbon steel, and sulphur steel
- Joins hard to weld steels easily
- Vertical, flat, and fillet welding
- Suits AC or DC Machines

Alloy	Size	5# Box	10# Box	50# Box	Amperage
6010	1/8"	#70250	#70182	-	65-130 AMP
	5/32"	-	#70253	-	130-180 AMP
6011	3/32"	#70066	-	-	20-75 AMP
	1/8"	#70067	#70164	#70165	75-130 AMP
	5/32"	#70167	#70166	#70168	130-180 AMP
6013	3/32"	#70072	-	-	20-75 AMP
	1/8"	#70073	#70169	-	75-130 AMP
	5/32"	#70249	-	-	130-180 AMP
7014	1/8"	#70251	-	-	65-130 AMP
7018	3/32"	#70074	-	-	20-75 AMP
	1/8"	#70075	#70170	#70171	75-130 AMP
	5/32"	-	-	#70172	75-130 AMP



Other Items Available Upon Request

Welding Wire

Alloy	Size	2# Roll	10# Roll	11# Roll	33# Roll
Mig Wire (No Flux)	.030"	-	-	#70176	-
	.035"	-	-	#70177	#70178
	.045"	-	-	-	#70179
Flux Wire	.030"	#70080	#70180	-	-
	.035"	#70081	#70181	-	-



Trimnable Type 29 Zirconia Flap Discs

Item #	Diameter x Width x Arbor	Density	Grit	Max RPM	Wt. lbs.	Qty.
#70129	4-1/2" x 5/8"-11	High	36	13,300	0.35 lbs.	10
#70130	4-1/2" x 5/8"-11	High	40	13,300	0.35 lbs.	10
#70131	4-1/2" x 5/8"-11	High	60	13,300	0.30 lbs.	10
#70132	4-1/2" x 5/8"-11	High	80	13,300	0.30 lbs.	10
#70133	4-1/2" x 5/8"-11	High	120	13,300	0.30 lbs.	10

Item #	Diameter x Width x Arbor	Density	Grit	Max RPM	Wt. lbs.	Qty.
#70134	4-1/2" x 5/8"-11	Standard	36	13,300	0.25 lbs.	10
#70135	4-1/2" x 5/8"-11	Standard	40	13,300	0.25 lbs.	10
#70136	4-1/2" x 5/8"-11	Standard	60	13,300	0.25 lbs.	10
#70137	4-1/2" x 5/8"-11	Standard	80	13,300	0.25 lbs.	10
#70138	4-1/2" x 5/8"-11	Standard	120	13,300	0.25 lbs.	10



Trimmable Type 27 Zirconia Flap Discs

Item #	Diameter x Width x Arbor	Density	Grit	Max RPM	Wt. lbs.	Qty.
#70124	4-1/2" x 5/8"-11	High	36	13,300	0.30 lbs.	10
#70125	4-1/2" x 5/8"-11	High	40	13,300	0.30 lbs.	10
#70126	4-1/2" x 5/8"-11	High	60	13,300	0.30 lbs.	10
#70127	4-1/2" x 5/8"-11	High	80	13,300	0.30 lbs.	10
#70128	4-1/2" x 5/8"-11	High	120	13,300	0.30 lbs.	10



T27 Zirconia Flap Discs

Ferrous metals, steel, structural steel, rebar, pipe, bar stock

Item #	Diameter x Width x Arbor	Density	Grit	Max RPM	Wt. lbs.	Qty.
#70155	4-1/2" x 7/8"	Standard	24	13,300	0.15 lbs.	10
#70156	4-1/2" x 7/8"	Standard	40	13,300	0.15 lbs.	10
#70157	4-1/2" x 7/8"	Standard	60	13,300	0.15 lbs.	10
#70158	4-1/2" x 7/8"	Standard	80	13,300	0.15 lbs.	10
#70159	4-1/2" x 7/8"	Standard	120	13,300	0.15 lbs.	10



T29 Zirconia Flap Discs

Ferrous, non ferrous metals, grinding, blending, finishing

Item #	Diameter x Width	Density	Grit	Max RPM	Wt. lbs.	Qty.
#70139	4-1/2" x 7/8"	High	40	13,300	0.30 lbs.	10
#70140	4-1/2" x 7/8"	Standard	24	13,300	0.30 lbs.	10
#70141	4-1/2" x 7/8"	Standard	36	13,300	0.30 lbs.	10
#70142	4-1/2" x 7/8"	Standard	40	13,300	0.30 lbs.	10
#70143	4-1/2" x 7/8"	Standard	60	13,300	0.30 lbs.	10
#70144	4-1/2" x 7/8"	Standard	80	13,300	0.30 lbs.	10
#70145	4-1/2" x 7/8"	Standard	120	13,300	0.30 lbs.	10

Item #	Diameter x Width x Arbor	Density	Grit	Max RPM	Wt. lbs.	Qty.
#70146	4-1/2" x 5/8"-11	High	24	13,300	0.55 lbs.	10 *
#70147	4-1/2" x 5/8"-11	High	36	13,300	0.55 lbs.	10 *
#70148	4-1/2" x 5/8"-11	High	40	13,300	0.55 lbs.	10 *
#70149	4-1/2" x 5/8"-11	High	60	13,300	0.55 lbs.	10 *
#70150	4-1/2" x 5/8"-11	High	80	13,300	0.55 lbs.	10 *
#70151	4-1/2" x 5/8"-11	High	120	13,300	0.55 lbs.	10 *
#70152	4-1/2" x 5/8"-11	Standard	120	13,300	0.55 lbs.	10 *

*With Hub

Item #	Diameter x Width x Arbor	Density	Grit	Max RPM	Wt. lbs.	Qty.
#70153	5" x 5/8"-11	High	40	12,200	0.55 lbs.	10 *
#70154	5" x 5/8"-11	High	60	12,200	0.55 lbs.	10 *

*With Hub



Stationary Saw Cut-Off Wheels, Double Reinforced

Ferrous metals, steel, structural steel, rebar, bar stock

Item #	Diameter x Width x Arbor	Max RPM	Wt. lbs.	Qty.
#70120	16" x 1/8" x 1"	3,800	1.40 lbs.	10
#70121	16" x 5/32" x 1"	3,800	1.40 lbs.	10
#70122	18" x 5/32" x 1"	3,400	1.53 lbs.	5
#70123	20" x 5/32" x 1"	3,000	4.40 lbs.	5



Type 1 Low Horsepower Chop Saw Wheels

Double Reinforce: cut thin wall tube, light-gauge ferrous metals, thin merchant bars
Center Reinforce: ferrous metals, structural steel, small merchant bars, steel tubing

Item #	Reinforce Type	Diameter x Width x Arbor	Max RPM	Wt. lbs.	Qty.
#70090	Double	14" x 3/32" x 1"	4,400	1.40 lbs.	10
#70091	Center	14" x 7/64" x 1"	4,400	1.50 lbs.	10



Type 1 Portable Circular Saw Wheels

Ferrous metals, rebar, bar stock

Item #	Reinforce Type	Diameter x Width x Arbor	Max RPM	Wt. lbs.	Qty.
#70113	Double	7" x 1/8" x 5/8"	8,700	0.04 lbs.	25



Type 1 High Speed Cut-Off Wheels For Portable Gas Saws

Ferrous metals, structural steel, rebar, bar stock, steel decking

Item #	Reinforce Type	Diameter x Width x Arbor	Max RPM	Wt. lbs.	Qty.
#70117	Double	12" x 1/8"(5/32) x 20mm	6,300	1.53 lbs.	10
#70118	Double	14" x 1/8"(5/32) x 1"	5,400	2.10 lbs.	10
#70119	Double	14" x 1/8"(5/32) x 20mm	5,460	2.10 lbs.	10



Type 1 High Speed Cut-Off Wheels

Ferrous metals, structural steel, thin rebar, thin iron pipe, bar stock, light-gauge steel

Item #	Reinforce Type	Diameter x Width x Arbor	Grit	Max RPM	Wt. lbs.	Qty.
#70114	Double	3" x 1/16" x 3/8"	M	25,000	0.05 lbs.	100
#70115	Double	3" x 1/16" x 3/8"	C	25,000	0.05 lbs.	100
#70116	Double	4-1/2" x 1/16" x 7/8"	C	13,300	1.00 lbs.	50



Type 1 Cut-Off Wheels

Alloy, rebar, metal tubing, light-gauge metals

Item #	Reinforce Type	Diameter x Width x Arbor	Max RPM	Wt. lbs.	Qty.
#70101	Double	4.5" x .045" x 7/8"	13,300	0.07 lbs.	50
#70102	Double	5" x .045" x 7/8"	12,200	0.12 lbs.	25
#70103	Double	6" x 1/16" x 7/8"	10,200	0.16 lbs.	25



T27 Depressed Center Pipe Cutting And Grinding Wheels - Single Grit

Ferrous metals, structural steel, rebar, pipe, bar stock, welds

Item #	Diameter x Width x Arbor	Max RPM	Wt. lbs.	Qty.
#70097	4-1/2" x 1/8" x 7/8"	13,300	0.19 lbs.	25
#70098	4-1/2" x 1/8" x 5/8"-11	13,300	0.40 lbs.	20 *
#70099	5" x 1/8" x 7/8"	12,200	0.32 lbs.	25
#70100	5" x 1/8" x 5/8"-11	12,200	0.60 lbs.	20 *



*With Hub

Type 27 Depressed Center Grinding Wheels - Single Grit

Ferrous metals, structural steel, rebar, pipe, bar stock, welds

Item #	Diameter x Width x Arbor	Max RPM	Wt. lbs.	Qty.
#70104	4-1/2" x 1/4" x 7/8"	13,300	0.35 lbs.	25
#70105	4-1/2" x 1/4" x 5/8"-11	13,300	0.55 lbs.	20 *
#70106	5" x 1/4" x 7/8"	12,200	0.40 lbs.	25
#70107	5" x 1/4" x 5/8"-11	12,200	0.65 lbs.	20 *
#70108	7" x 1/4" x 7/8"	8,500	0.85 lbs.	20
#70109	7" x 1/4" x 5/8"-11	8,500	1.20 lbs.	10 *

*With Hub



Type 27 Depressed Center Grinding Wheels - Dual Grit

Ferrous metals, structural steel, rebar, pipe, bar stock, welds

Item #	Diameter x Width x Arbor	Max RPM	Wt. lbs.	Qty.
#70092	4-1/2" x 1/4" x 7/8"	13,300	0.34 lbs.	25
#70093	4-1/2" x 1/4" x 5/8"-11	13,300	0.55 lbs.	20 *
#70094	6" x 1/4" x 5/8"-11	10,200	0.70 lbs.	10 *
#70095	7" x 1/4" x 7/8"	8,500	0.84 lbs.	20
#70096	7" x 1/4" x 5/8"-11	8,500	1.10 lbs.	10 *

*With Hub



Type 27 Depressed Center Cut-Off Wheels

Alloy, rebar, metal tubing, light-gauge metals

Item #	Reinforce Type	Diameter x Width x Arbor	Max RPM	Wt. lbs.	Qty.
#70111	Double	4.5" x .045" x 5/8"-11	13,300	0.12 lbs.	20 *
#70112	Double	4.5" x .045" x 7/8"	13,300	0.07 lbs.	50
#70110	Double	6" x .045" x 7/8"	10,200	0.15 lbs.	25

*With Hub



Stringer Bead Wire Wheel

Item #	Diameter x Width x Arbor	Max RPM	Wt. lbs.	Qty.
#70205	4" x 3/16" x 5/8"-11	20,000	0.50 lbs.	6



Knot Cup Brush

Item #	Type	Diameter x Width x Arbor	Max RPM	Wt. lbs.	Qty.
#70204	Knot	2-3/4" x 5/8"-11	14,000	0.66 lbs.	6
#70206	Crimped	2-3/4" x 5/8"-11	12,500	1.50 lbs.	12



Knot Wire Wheel - Standard Twist

Item #	Diameter x Width x Arbor	Max RPM	Wt. lbs.	Qty.
#70202	4" x 1/2" x 5/8"-11	20,000	0.67 lbs.	6



Crimped Wire Wheel

Item #	Diameter x Width x Arbor	Max RPM	Wt. lbs.	Qty.
#70203	4" x 1/2" x 5/8"-11	12,500	0.50 lbs.	6



WELDING JACK / PIPE / WELDINGS STANDS

Roller Head Attachment

Item #	Accommodates Pipe	Weight Capacity	Fits Stand	Wt. lbs.	Qty.
#80203	1-1/4" to 24"	2,000	#80458	9.68 lbs.	1



Roller Head Wheel Attachment

Item #	Wt. lbs.	Qty.
<i>New</i> #80801	8.64 lbs.	1



Ball Transfer Head Attachment

Item #	Weight Capacity	Wt. lbs.	Qty.
#80204	1,000	5.57 lbs.	1



Extended "V" Head Attachment

Item #	Fits Stand	Wt. lbs.	Qty.
<i>New</i> #80802	#80458	11.36 lbs.	1



Sumner® Fold-A-Jack Pipe Stands

Item #	Type	Weight Capacity	Height	Wt. lbs.	Qty.
#80165	Lo Jack	2,500	36"	23.0 lbs.	1
#80052	Hi Jack	2,500	49"	25.0 lbs.	1



Spring Creek™ Products Foldable Jack Stand

Item #	Height	Weight Capacity	Wt. lbs.	Qty.
#80458	33" to 47"	2,500	24.10 lbs.	1



RevMark™ QuickDraw Markers

Item #	Color	Box Style	Wt. lbs.	Qty.
#50647	Assorted	Display	0.35 lbs.	27
#50648	White	Display	0.35 lbs.	27
#80177	White	Replacement	0.01 lbs.	12



Bullet Hinges

These hinges are sold in pairs and packaged in clamshells.

Steel Body - Brass Pin And Bushing - No Grease Zerk

Item #	Size	Length	Thickness	Diameter	Pin Size	Wt. lbs.	Qty. (Pairs)
#70212	3-3/16"	3-3/16"	5/8"	1/2"	5/16"	0.38 lbs.	10 *
#70213	4"	3-15/16"	3/4"	5/8"	3/8"	0.70 lbs.	10 *

*Sold individually on page 8



Steel Body And Pin - Brass Bushing - With Grease Zerk

Item #	Size	Length	Thickness	Diameter	Pin Size	Wt. lbs.	Qty. (Pairs)
#70214	3-3/16"	3-3/16"	5/8"	1/2"	5/16"	0.38 lbs.	10 *
#70215	4"	4"	3/4"	5/8"	3/8"	0.72 lbs.	10 *
#70216	4-3/4"	4-3/4"	3/4"	5/8"	3/8"	1.18 lbs.	10 *

*Sold individually on page 9



Steel Body And Pin - No Grease Zerk

Item #	Size	Diameter	Pin Size	Wt. lbs.	Qty. (Pairs)
#70217	3"	3/4"	1"	0.76 lbs.	10 *

*Sold individually on page 9

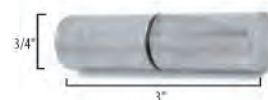

Square Hinge

Item #	Size	Size (Length x Width x Height)	Pin	Finish	Wt. lbs.	Qty.
#70218	5"	5" x 1-1/4" x 1"	5/8"	Bare	1.74 lbs.	10



Check out our variety of hinges and other accessories for your BBQ pit project!!! Available on pages 7-12.



Sumner® Welder's Stool

Item #	Height	Weight Capacity	Wt. lbs.	Qty.
#80689	15" to 22"	300	18.69 lbs.	1



WELDING FIRE PITS AND GRILLS

Specialty Metal Art Cookers

Item #	Type	Thickness	Finish	Wt. lbs.	Qty.
#46065	(A) Chicken Cooker	3/16"	Bare	2.75 lbs.	1
#46116	(B) Jalapeno Cooker	7ga	Bare	4.56 lbs.	1

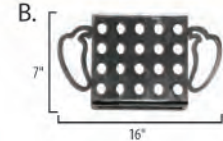

Fire Pit Cooking Grate

Item #	Size	Finish	Wt. lbs.	Qty.
#80686	40" x 24-3/8"	Bare	17.20 lbs.	1



20" Grill Pan

Item #	Grill Size	Finish	Wt. lbs.	Qty.
#50538	20"	Bare	20.00 lbs.	1



Tank Head - Dished

Item #	Size	Finish	Wt. lbs.	Qty.
#80000	20" x 3/16"	Bare	23.00 lbs.	1

This item does not qualify for free freight



Texas Bird Bath Weld Kit

Item #	Height	Grill Size	Steel Base	Finish	Wt. lbs.	Qty.
#49385	26"-32"	20"	20"	Bare	60.00 lbs.	1

This item does not qualify for free freight



3-in-1 Fire Pit Weld Kit

Item #	Height	Grill Size	Finish	Wt. lbs.	Qty.
#49384	16"	20"	Bare	60.00 lbs.	1

This item does not qualify for free freight



Portable Fire Bowl

Item #	Size	Finish	Wt. lbs.	Qty.
<i>New</i> #80980	24" x 12"	Bare	18.00 lbs.	1

This item does not qualify for free freight



Fire Pit Bowls

Item #	Diameter x Depth	Thickness	Finish	Wt. lbs.	Qty.
#80232	31-3/4" x 9"	3/16"	Bare	66.67 lbs.	1
<i>New</i> #80806	23-3/4" x 6-3/4"	3/16"	Bare	41.07 lbs.	1
<i>New</i> #80807	35-1/2" x 10"	3/16"	Bare	81.04 lbs.	1
<i>New</i> #80808	43-3/4" x 12"	3/16"	Bare	119.90 lbs.	1

These items do not qualify for free freight



Fire Pit Kits

Item #	Style	Grill Size	Wt. lbs.	Qty.
#50412	Star	36"	81.00 lbs.	1
#50414	Star	48"	112.00 lbs.	1
#50413	Horse	36"	81.00 lbs.	1
#50415	Horse	48"	112.00 lbs.	1
#80099	Cowboy	36"	81.00 lbs.	1
#80100	Cowboy	48"	112.00 lbs.	1

These items do not qualify for free freight



1/2" Threaded Coupling

Item #	Size (Width x Height)	Fits	Finish	Weight	Qty.
#80194	1" x 1-1/2"	#48613 #49491 #48614	Bare	0.18 lbs.	240



BBQ Pit Thermometers

Item #	Size	Stem	Wt. lbs.	Qty.
#48612	2"	2-1/2"	0.12 lbs.	1
#48613	3"	2-1/2"	0.34 lbs.	1
#49491	3"	5"	0.35 lbs.	1
#48614	4"	2-1/2"	0.55 lbs.	1



Ball Valve

Item #	Size	Style	Finish	Wt. lbs.	Qty.
#50263	1-1/4"	Female/Female	Brass	1.75 lbs.	4

THIS ITEM IS NOT APPROVED FOR ANY OTHER APPLICATIONS, BESIDES SMOKERS



Solid Steel Ball

Item #	Finish	Wt. lbs.	Qty.
<i>New</i> #81053	Bare	0.15 lbs.	100



BBQ Vents

Item #	Size	Center Hole	Finish	Wt. lbs.	Qty.
<i>New</i> #80981	4" x 11ga	1/4"	Bare	0.24 lbs.	10
<i>New</i> #80982	6" x 11ga	3/8"	Bare	0.55 bs.	10
<i>New</i> #80983	8" x 11ga	3/8"	Bare	0.98 lbs.	10

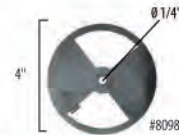

Steel Handle

Item #	Size (Length x Width)	Rod Diameter	Finish	Wt. lbs.	Qty.
#50559	6-1/2" x 2-1/2"	1/2"	Bare	0.45 lbs.	25

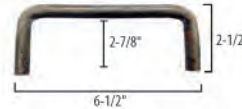

Spring Steel Handles

Item #	Size (Length x Width)	Threaded	Finish	Wt. lbs.	Qty.
<i>New</i> #50504	6" x 3-5/8"	No	Bare	0.75 lbs.	20
<i>New</i> #80975	6-1/2" x 4-5/8"	Yes	Bare	1.08 lbs.	20

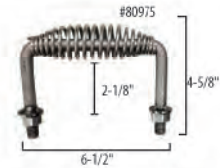
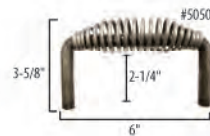

Spring Handles

Item #	Size	Hole	Style	Wt. lbs.	Qty.
#47691	4-1/2"	3/8"	Zinc	0.23 lbs.	25
#48239	4-1/2"	3/8"	Bare	0.23 lbs.	20
#49838	5"	3/8"	Stainless	0.29 lbs.	20
#80388	5"	5/8"	Stainless	0.34 lbs.	20
#49450	6"	1/2"	Zinc	0.33 lbs.	20
#49198	6"	5/8"	Bare	0.55 lbs.	20
#49805	6"	1/2"	Stainless	0.33 lbs.	20

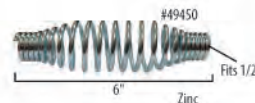
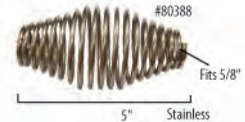

Cast Iron BBQ Wheels And Mounting Kit

Item #	Wheel Size (Diameter x Width)	Finish	Wt. lbs.	Qty.
#49503	4" x 1-1/4"	Bare	1.38 lbs.	10
#49504	5" x 1-1/4"	Bare	1.79 lbs.	10
#50400	Kit	Bare	1.05 lbs.	10 (Wheel Not Included)

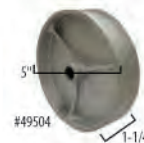

Welding Tabs

These welding tabs are available in a variety of sizes and styles to fit your needs!

Single Hole With Rounded Corners

Item #	Size (Height x Width)	Thickness	Hole	Finish	Wt. lbs.	Qty.
#49456	1-1/2" x 1"	1/8"	3/8"	Bare	0.03 lbs.	100
#80379	1-3/4" x 1-7/16"	1/4"	1/2"	Bare	0.14 lbs.	100
#50069	2" x 1-1/4"	3/16"	1/2"	Bare	0.14 lbs.	100
#49455	2-3/8" x 1"	1/8"	3/8"	Bare	0.06 lbs.	100
#49120	2-3/4" x 1"	3/16"	3/8"	Bare	0.09 lbs.	100
#49121	3-1/2" x 1"	3/16"	3/8"	Bare	0.14 lbs.	100

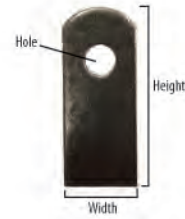

Single Hole With Square Corners

Item #	Size (Height x Width)	Thickness	Hole	Finish	Wt. lbs.	Qty.
#49124	2-1/2" x 1-1/2"	1/8"	3/8"	Bare	0.09 lbs.	100



Double Hole

Item #	Size (Height x Width)	Thickness	Hole	Finish	Wt. lbs.	Qty.
#49665	3-1/4" x 1"	3/16"	3/8"	Bare	0.20 lbs.	100
#49926	3-7/8" x 1-1/2"	8ga	3/8"	Bare	0.23 lbs.	180



Single Oval Hole

Item #	Size (Height x Width)	Thickness	Hole	Finish	Wt. lbs.	Qty.
#49122	2-3/8" x 1"	1/8"	3/4" x 1/4"	Bare	0.05 lbs.	100



Single Hole With Side Tabs

Item #	Size (Height x Width)	Thickness	Hole	Finish	Wt. lbs.	Qty.
#49984	2-3/4" x 2"	12ga	3/8"	Bare	0.13 lbs.	230
#49985	3-1/4" x 2"	12ga	3/8"	Bare	0.10 lbs.	200



Bent Side Tabs

Item #	Size (Height x Depth x Width)	Thickness	Hole	Finish	Wt. lbs.	Qty.
#80380	1-13/16" x 1-5/8" x 1"	13ga	3/8"	Bare	0.10 lbs.	100

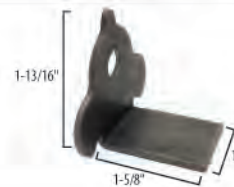

Single Hole With Bent Tab

Item #	Size (Height x Depth x Width)	Thickness	Hole	Finish	Wt. lbs.	Qty.
#49982	1-1/2" x 1-1/2" x 1-1/2"	9ga	3/8"	Bare	0.16 lbs.	120
#49980	2" x 1-1/2" x 1"	9ga	3/8"	Bare	0.13 lbs.	180
#49981	3-1/8" x 1-1/2" x 1"	9ga	3/8"	Bare	0.16 lbs.	120
#49667	3-1/8" x 1-5/8" x 1-1/4"	3/16"	3/8"	Bare	0.35 lbs.	100
#49983	3-1/2" x 1-1/2" x 1-1/2"	8ga	3/8"	Bare	0.28 lbs.	80



Panel Mount Brackets

Item #	Size (Fits Into)	Mount Size (Width x Length)	Finish	Wt. lbs.	Qty.
#50289	1"	1" x 2-1/4"	Powder Coat	0.20 lbs.	100
#80478	1-1/4"	1-1/4" x 2-1/2"	Bare	0.27 lbs.	100
#80479	1-1/2"	1-1/2" x 2-3/4"	Bare	0.38 lbs.	100
#80480	2"	2" x 4"	Bare	0.63 lbs.	100



Angle Brackets

Item #	Size (Length x Width x Height)	Thickness	Finish	Wt. lbs.	Qty.
#47687	3" x 3" x 2"	10ga	Bare	0.43 lbs.	80
#47688	4" x 3" x 4"	10ga	Bare	1.03 lbs.	32
#47689	5" x 3" x 6"	10ga	Bare	1.75 lbs.	20



Angle Bracket With Holes

Item #	Size	Hole (Diameter x Number)	Thickness	Finish	Wt. lbs.	Qty.
#49716	(A) 2"	1/4" x 4	1/8"	Bare	0.27 lbs.	60
#50444	(B) 2"	3/16" x 2	1/8"	Powder	0.35 lbs.	25

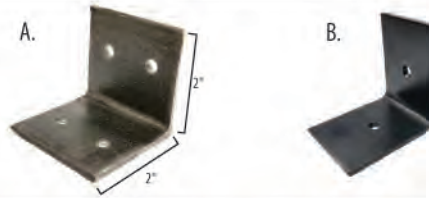

*If you need help with an order, have questions about our products,
or have an inquiry about setting up an account,
please contact a member of our team today!*

We'd love to hear from you!

1-866-651-6702 or sales@springcreekproducts.com

Purlin Clips (Blank, No Holes)

Item #	Size (Length x Width)	Thickness	Finish	Wt. lbs.	Qty.
#80411	5" x 3"	10ga	Bare	0.58 lbs.	50 / box 500 / pallet
#45911	5" x 3"	10ga	Bare	0.58 lbs.	500 / pallet
#80141	5" x 3"	3/16"	Bare	0.78 lbs.	40
<i>New</i> #80809	7" x 5"	10ga	Bare	1.36 lbs.	10
#80412	7" x 5"	3/16"	Bare	1.95 lbs.	10 / box 500 / pallet
#45912	7" x 5"	3/16"	Bare	1.95 lbs.	500 / pallet
#80248	8-1/2" x 3"	3/16"	Bare	2.00 lbs.	10



Purlin Angle Clip

Item #	Size (Length x Width x Height)	Thickness	Finish	Wt. lbs.	Qty.
#80055	2-3/4" x 2" x 2"	10ga	Bare	0.37 lbs.	12

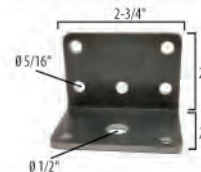

Purlin Chairs

Item #	Fits Size (Purlin)	Size (Length x Width x Height)	Thickness	Finish	Wt. lbs.	Qty.
#80053	1-1/2"	3" x 1-3/4" x 4-1/2"	10ga	Bare	0.65 lbs.	12
#80054	2"	3" x 2-5/16" x 4-1/2"	10ga	Bare	0.76 lbs.	12



Base Punch Plates

Item #	Square	Hole (Suits bolt size)	Thickness	Finish	Wt. lbs.	Qty.
#49116	3"	3/8"	3/16"	Bare	0.40 lbs.	20
#49113	4"	3/8"	3/16"	Bare	0.74 lbs.	20
#50250	4"	7/16"	3/16"	Bare	0.73 lbs.	50
#50326	5"	3/8"	3/16"	Bare	1.30 lbs.	10
#50278	5"	3/8"	1/4"	Bare	1.60 lbs.	10
#50318	5"	1/2"	1/4"	Bare	1.57 lbs.	25
#49842	6"	1/2"	1/4"	Bare	2.09 lbs.	10
#49840	8"	9/16"	1/4"	Bare	4.38 lbs.	10
#80066	8"	9/16"	3/8"	Bare	6.70 lbs.	5
#80476	10"	9/16"	5/16"	Bare	9.63 lbs.	8

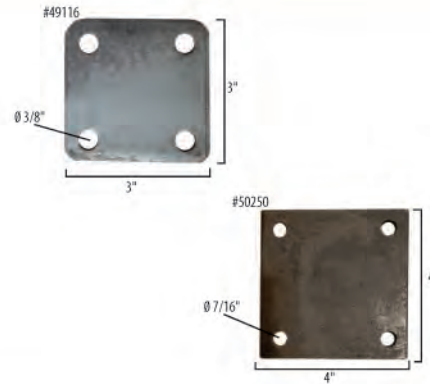

Visit us at
www.springcreekproducts.com

Square Plates - For Round Tubing

Item #	Outside Square	Fits Over	Thickness	Finish	Wt. lbs.	Qty.
#80601	3"	1.05" O.D.	3/16"	Bare	0.43 lbs.	50
#80602	4"	1-1/4" O.D.	3/16"	Bare	0.78 lbs.	50
#80603		1.315" O.D.		Bare	0.76 lbs.	50
#80604		1-1/2" O.D.		Bare	0.74 lbs.	50
#80605		1.66" O.D.		Bare	0.73 lbs.	10
#80606		1.90" O.D.		Bare	0.70 lbs.	50
#80607	5"	1.90" O.D.	1/4"	Bare	1.54 lbs.	10
#80608		2-3/8" O.D.		Bare	1.45 lbs.	10
#80609		2-7/8" O.D.		Bare	1.30 lbs.	10
#80610	6"	3-1/2" O.D.	1/4"	Bare	1.85 lbs.	10
#80611		4-1/2" O.D.	1/4"	Bare	1.40 lbs.	10
#80612		3/8"	Bare	2.11 lbs.	10	
#80613	8"	6-5/8" O.D.	1/4"	Bare	2.13 lbs.	10
#80614			3/8"	Bare	3.04 lbs.	10

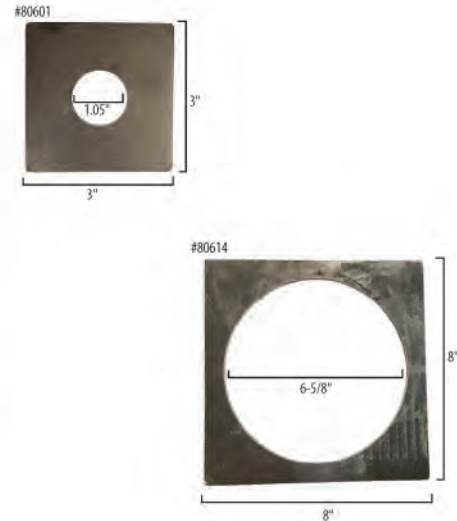

Square Plates With Holes - For Round Tubing

Item #	Outside Square	Fits Over	Hole Size	Thickness	Finish	Wt. lbs.	Qty.
#80503	3"	1.05" O.D.	0.40"	3/16"	Bare	0.40 lbs.	20
#80504	4"	1-1/4" O.D.	0.40"	3/16"	Bare	0.76 lbs.	20
#80505		1.315" O.D.		3/16"	Bare	0.73 lbs.	10
#80506		1-1/2" O.D.		3/16"	Bare	0.73 lbs.	20
#80507		1.66" O.D.		3/16"	Bare	0.71 lbs.	10
#80508		1.90" O.D.		3/16"	Bare	0.66 lbs.	10
#80509	5"	1.90" O.D.	0.40"	1/4"	Bare	1.53 lbs.	10
#80510		2-3/8" O.D.		1/4"	Bare	1.42 lbs.	20
#80511		2-7/8" O.D.		1/4"	Bare	1.27 lbs.	10
#80512		3-1/2" O.D.		0.56"	1/4"	Bare	1.74 lbs.
#80513	4-1/2" O.D.	1/4"	Bare		1.30 lbs.	10	
#80514	6"	4-1/2" O.D.	0.56"	3/8"	Bare	1.98 lbs.	10
#80515	8"	6-5/8" O.D.	0.63"	1/4"	Bare	1.88 lbs.	10
#80516				3/8"	Bare	2.85 lbs.	10

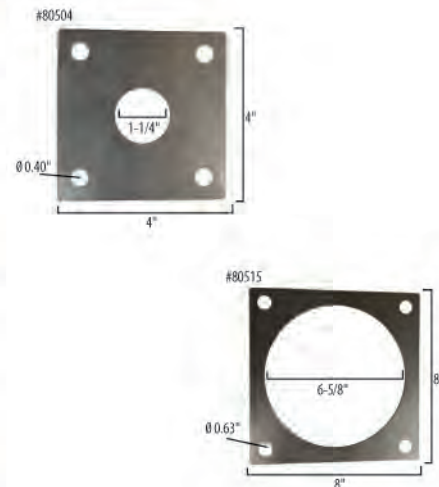

Square Plates - For Square Tubing

Item #	Outside Square	Fits Over	Thickness	Finish	Wt. lbs.	Qty.	
#80579	3"	1"	3/16"	Bare	0.42 lbs.	20	
#80580	4"	1-1/4"	3/16"	Bare	0.77 lbs.	20	
#80581		1-1/2"	3/16"	Bare	0.73 lbs.	20	
#80587			1/4"	Bare	0.91 lbs.	10	
#80582		2"	3/16"	Bare	0.63 lbs.	20	
#80588			1/4"	Bare	0.78 lbs.	10	
#80583		2-1/2"	3/16"	Bare	0.51 lbs.	50	
#80589			1/4"	Bare	0.64 lbs.	50	
#80584		5"	2"	3/16"	Bare	1.11 lbs.	10
#80590	1/4"			Bare	1.48 lbs.	10	
#80585	2-1/2"		3/16"	Bare	0.98 lbs.	10	
#80591			1/4"	Bare	1.18 lbs.	10	
#80586	3"		3/16"	Bare	0.84 lbs.	10	
#80592			1/4"	Bare	1.11 lbs.	10	
#80593	6"		3"	1/4"	Bare	1.85 lbs.	10
#80595				3/8"	Bare	2.82 lbs.	10
#80594		4"	1/4"	Bare	1.39 lbs.	10	
#80596			3/8"	Bare	2.08 lbs.	10	
#80597	8"	3"	1/4"	Bare	3.84 lbs.	10	
#80599			3/8"	Bare	5.76 lbs.	10	
#80598		4"	1/4"	Bare	3.36 lbs.	10	
#80600			3/8"	Bare	5.06 lbs.	10	

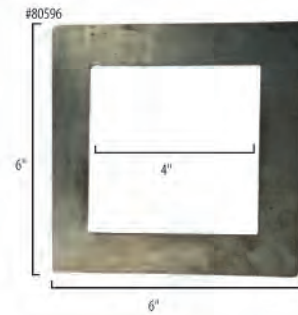
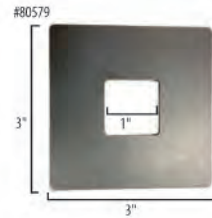

Square Plates With Holes - For Square Tubing

Item #	Outside Square	Fits Over	Hole Size	Thickness	Finish	Wt. lbs.	Qty.
#80481	3"	1"	0.40"	3/16"	Bare	0.39 lbs.	50
#80482	4"	1-1/4"	0.40"	3/16"	Bare	0.74 lbs.	50
#80483		1-1/2"		3/16"	Bare	0.69 lbs.	50
#80489				1/4"	Bare	0.86 lbs.	10
#80484		2"		3/16"	Bare	0.61 lbs.	20
#80490				1/4"	Bare	0.74 lbs.	10
#80486		5"		2"	0.40"	3/16"	Bare
#80492	0.56"		1/4"		Bare	1.31 lbs.	10
#80487	2-1/2"		0.40"	3/16"	Bare	0.96 lbs.	10
#80493			0.56"	1/4"	Bare	1.15 lbs.	10
#80488	3"		0.40"	3/16"	Bare	0.81 lbs.	10
#80494			0.56"	1/4"	Bare	0.97 lbs.	10
#80495	6"	3"	0.56"	1/4"	Bare	1.69 lbs.	10
#80497				3/8"	Bare	2.73 lbs.	10
#80499	8"	3"	0.63"	1/4"	Bare	3.56 lbs.	10
#80501				3/8"	Bare	5.65 lbs.	10
#80500		4"		1/4"	Bare	3.33 lbs.	10
#80502				3/8"	Bare	4.94 lbs.	10

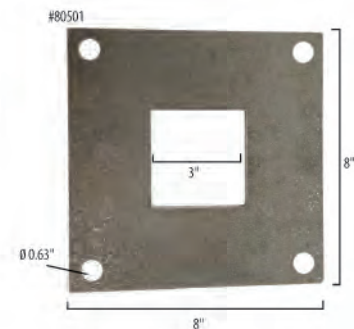
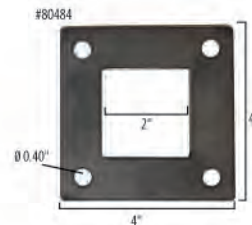

Square Weld Flange

Item #	Size (Length x Width)	Thickness	Hole	Finish	Wt. lbs.	Qty.
#49979	4" x 4" (Inner Sq. 1-1/2")	9ga	3/8"	Bare	0.05 lbs.	100



Round Plates - For Round Tubing

Item #	Outside Diameter	Fits Over	Thickness	Finish	Wt. lbs.	Qty.
#80615	3-1/8"	1.05" O.D.	12ga	Bare	0.19 lbs.	50
#80616	3-1/4"	1-1/4" O.D.	12ga	Bare	0.21 lbs.	49
#80617	3-3/8"	1.315" O.D.	12ga	Bare	0.22 lbs.	50
#80618	3-1/2"	1-1/2" O.D.	12ga	Bare	0.23 lbs.	50
#80619	3-3/4"	1.66" O.D.	12ga	Bare	0.26 lbs.	10
#80620	4"	1.90" O.D.	3/16"	Bare	0.51 lbs.	10
#80621	4-3/8"	2-3/8" O.D.	3/16"	Bare	0.55 lbs.	10
#80622			1/4"	Bare	0.74 lbs.	10
#80623	5-5/8"	2-7/8" O.D.	3/16"	Bare	0.96 lbs.	10
#80624			1/4"	Bare	1.33 lbs.	10

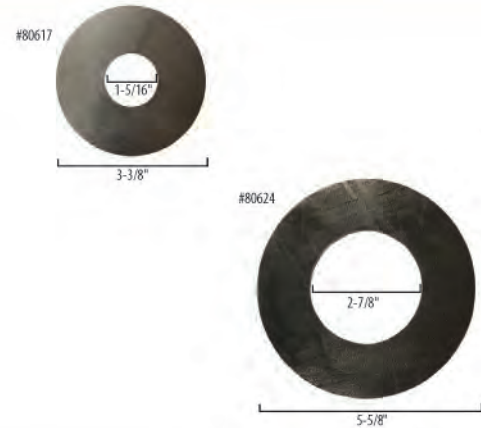

Round Plates With 3 Holes - For Round Tubing

Item #	Outside Diameter	Fits Over	Hole Size	Thickness	Finish	Wt. lbs.	Qty.
#80517	3-1/8"	1.05" O.D.	0.26"	12ga	Bare	0.19 lbs.	50
#80518	3-1/4"	1-1/4" O.D.	0.26"	12ga	Bare	0.21 lbs.	30
#80519	3-3/8"	1.315" O.D.	0.26"	12ga	Bare	0.22 lbs.	50
#80520	3-1/2"	1-1/2" O.D.	0.316"	12ga	Bare	0.22 lbs.	40
#80521	3-3/4"	1.66" O.D.	0.316"	12ga	Bare	0.24 lbs.	50
#80522	4"	1.90" O.D.	0.316"	3/16"	Bare	0.49 lbs.	10
#80523	4-3/8"	2-3/8" O.D.	0.316"	3/16"	Bare	0.53 lbs.	10
#80524			0.380"	1/4"	Bare	0.66 lbs.	10
#80525	5-5/8"	2-7/8" O.D.	0.380"	3/16"	Bare	0.95 lbs.	10
#80526			1/4"	Bare	1.18 lbs.	10	

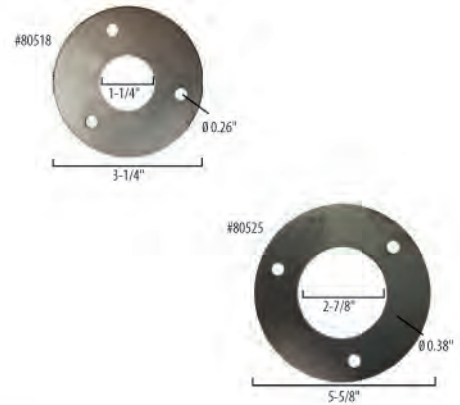

Sign Up To Order Online!



It's simple and easy! Place orders, view product information, prices, and invoices.

Contact your sales representative for more information at 866-651-6702

Check out our website: www.springcreekproducts.com

Round Plates With 4 Holes - For Round Tubing

Item #	Outside Diameter	Fits Over	Hole Size	Thickness	Finish	Wt. lbs.	Qty.
#80527	3-3/4"	1.66" O.D.	0.40"	1/4"	Bare	0.59 lbs.	10
#80528	4"	1.90" O.D.	0.40"	1/4"	Bare	0.61 lbs.	10
#80529	4-3/8"	2-3/8" O.D.	0.40"	1/4"	Bare	0.66 lbs.	10
#80530	5-5/8"	2-7/8" O.D.	0.56"	1/4"	Bare	1.14 lbs.	10
#80531	6-1/4"	3-1/2" O.D.	0.56"	3/8"	Bare	2.07 lbs.	10
#80532	7-1/4"	4-1/2" O.D.	0.56"	3/8"	Bare	2.55 lbs.	10

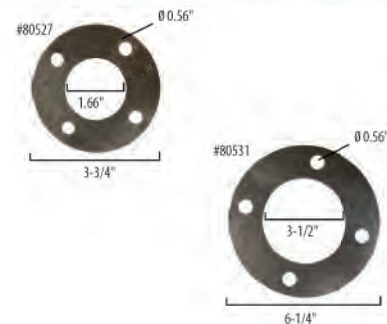

Gusset Triangle Plates

Item #	Size (Height x Hypotenuse)	Thickness	Finish	Wt. lbs.	Qty.
#49847	2" x 2-3/4"	3/8"	Bare	0.20 lbs.	200
#50023	5-11/16" x 7-7/8"	1/4"	Bare	1.20 lbs.	25



Triangular Plates - Equal Sides

Item #	Size	Thickness	Finish	Wt. lbs.	Qty.
#80533	2"	3/16"	Bare	0.01 lbs.	50
#80534	2-1/2"	3/16"	Bare	0.16 lbs.	50
#80535	3"	3/16"	Bare	0.24 lbs.	40
#80536		1/4"	Bare	0.31 lbs.	50
#80537	3-1/2"	1/4"	Bare	0.43 lbs.	50
#80538	4"	1/4"	Bare	0.58 lbs.	40
#80539	4-1/2"	1/4"	Bare	0.74 lbs.	10
#80540	5"	1/4"	Bare	0.91 lbs.	10
#80541	5-1/2"	1/4"	Bare	1.03 lbs.	10
#80542	6"	1/4"	Bare	1.21 lbs.	10
#80543		3/8"	Bare	1.90 lbs.	10
#80544	8"	1/4"	Bare	2.18 lbs.	10
#80545		3/8"	Bare	3.39 lbs.	10



\$1,000+ Orders Ship For Free!!!!

**Call your sales representative
today to see if you qualify!**

1-866-651-6702



Some exclusions apply, offer subject to change without notice.

Triangular Plates - Equal Sides With Weld Notch

Item #	Size	Thickness	Finish	Wt. lbs.	Qty.
#80556	2"	3/16"	Bare	0.10 lbs.	50
#80557	2-1/2"	3/16"	Bare	0.16 lbs.	50
#80558	3"	3/16"	Bare	0.23 lbs.	50
#80559		1/4"	Bare	0.28 lbs.	50
#80560	3-1/2"	1/4"	Bare	0.42 lbs.	50
#80561	4"	1/4"	Bare	0.49 lbs.	50
#80562	4-1/2"	1/4"	Bare	0.73 lbs.	10
#80563	5"	1/4"	Bare	0.90 lbs.	10
#80564	5-1/2"	1/4"	Bare	1.01 lbs.	10
#80565	6"	1/4"	Bare	1.14 lbs.	10
#80566		3/8"	Bare	1.88 lbs.	10
#80567	8"	1/4"	Bare	2.18 lbs.	10
#80568		3/8"	Bare	3.38 lbs.	10

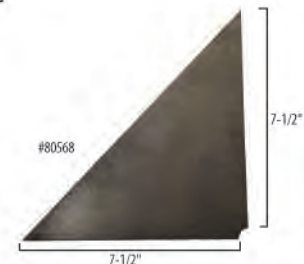

Triangular Plates - Unequal Sides

Item #	Size	Thickness	Finish	Wt. lbs.	Qty.
#80546	1" x 1-13/16"	12ga	Bare	0.02 lbs.	200
#80547	1-1/2" x 2-3/4"	3/16"	Bare	0.12 lbs.	200
#80548	2" x 3-3/4"	3/16"	Bare	0.21 lbs.	100
#80549		1/4"	Bare	0.26 lbs.	100
#80550	2-1/2" x 4-3/4"	1/4"	Bare	0.43 lbs.	40
#80551		3/8"	Bare	0.65 lbs.	40
#80552	3" x 5-3/4"	1/4"	Bare	0.64 lbs.	40
#80553		3/8"	Bare	0.95 lbs.	10
#80554	4" x 7-3/4"	1/4"	Bare	1.08 lbs.	20
#80555		3/8"	Bare	1.69 lbs.	10

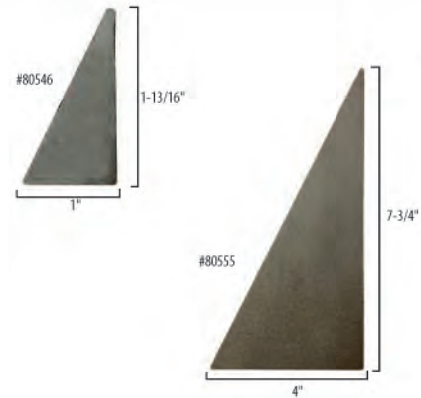

We want to see your
DIY projects!
Send us a photo at
sales@springcreekproducts.com
to strut your stuff, and we will
send you a free
Spring Creek™ Products Cap!

Check out page 107 for ideas!

Triangular Plates - Unequal Sides With Weld Notch

Item #	Size	Thickness	Finish	Wt. lbs.	Qty.
#80569	3/4" x 2"	12ga	Bare	0.02 lbs.	200
#80570	1-1/4" x 2-1/2"	3/16"	Bare	0.12 lbs.	100
#80571	1-3/4" x 4"	3/16"	Bare	0.21 lbs.	50
#80572		1/4"	Bare	0.27 lbs.	40
#80573	2-1/4" x 4-1/2"	1/4"	Bare	0.44 lbs.	40
#80574		3/8"	Bare	0.65 lbs.	40
#80575	2-3/4" x 5-1/2"	1/4"	Bare	0.64 lbs.	40
#80576		3/8"	Bare	0.92 lbs.	10
#80577	3-1/2" x 7-1/2"	1/4"	Bare	1.13 lbs.	20
#80578		3/8"	Bare	1.67 lbs.	10

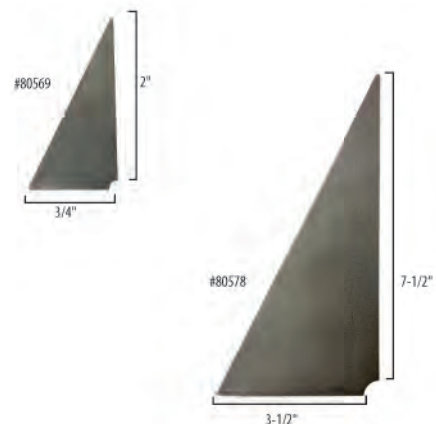



Letters And Numbers



Western Letters And Numbers - 4" Weld On

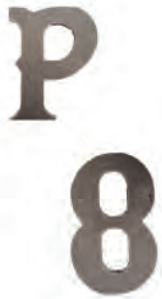

'A' - #46168	'J' - #46177	'S' - #46190	'1' - #46159
'B' - #46169	'K' - #46178	'T' - #46191	'2' - #46160
'C' - #46170	'L' - #46179	'U' - #46192	'3' - #46161
'D' - #46171	'M' - #46180	'V' - #46194	'4' - #46162
'E' - #46172	'N' - #46181	'W' - #46195	'5' - #46163
'F' - #46173	'O' - #46158	'X' - #46196	'6' - #46164
'G' - #46174	'P' - #46183	'Y' - #46198	'7' - #46165
'H' - #46175	'Q' - #46184	'Z' - #46199	'8' - #46166
'I' - #46176	'R' - #46189		'9' - #46164
			'0' - #46158

Western Letters And Numbers - 4" Bolt On

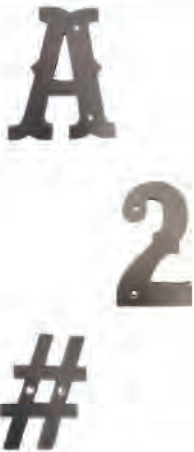

'A' - #50470	'J' - #50479	'S' - #50488	'1' - #50496	'#' - #50512
'B' - #50471	'K' - #50480	'T' - #50489	'2' - #50497	'9' - #50527
'C' - #50472	'L' - #50481	'U' - #50490	'3' - #50498	'The' - #50514
'D' - #50473	'M' - #50482	'V' - #50491	'4' - #50499	'and' - #50513
'E' - #50474	'N' - #50483	'W' - #50492	'5' - #50500	<small>(Symbols are not 4" tall)</small>
'F' - #50475	'O' - #50484	'X' - #50493	'6' - #50501	
'G' - #50476	'P' - #50485	'Y' - #50494	'7' - #50502	
'H' - #50477	'Q' - #50486	'Z' - #50495	'8' - #50503	
'I' - #50478	'R' - #50487		'9' - #50528	
			'0' - #50529	

New

Standard Letters And Numbers - 8" Weld On



'A' - #81003	'J' - #81012	'S' - #81021	'1' - #81030	'#' - #81041
'B' - #81004	'K' - #81013	'T' - #81022	'2' - #81031	'&' - #81040
'C' - #81005	'L' - #81014	'U' - #81023	'3' - #81032	'9' - #81039
'D' - #81006	'M' - #81015	'V' - #81024	'4' - #81033	'@' - #81042
'E' - #81007	'N' - #81016	'W' - #81025	'5' - #81034	'." - #81043
'F' - #81008	'O' - #81017	'X' - #81026	'6' - #81035	<small>(Symbols are not 8" tall)</small>
'G' - #81009	'P' - #81018	'Y' - #81027	'7' - #81036	
'H' - #81010	'Q' - #81019	'Z' - #81028	'8' - #81037	
'I' - #81011	'R' - #81020		'9' - #81038	
			'0' - #81029	

WELDING CUT-TO-LENGTH PRODUCTS

Threaded Rod - Grade A

New
New
New
New
New
New
New

Item #	Size	Length	Finish	Wt. lbs.	Qty.
#80829	1/4"	3'	Zinc	0.37 lbs.	1
#80825	3/8"	3'	Zinc	0.88 lbs.	1
#80828	1/2"	3'	Zinc	1.60 lbs.	1
#80824	5/8"	3'	Zinc	2.53 lbs.	1
#80827	3/4"	3'	Zinc	3.72 lbs.	1
#80826	7/8"	3'	Zinc	5.13 lbs.	1
#80830	1"	3'	Zinc	6.72 lbs.	1

Item #	Size	Length	Finish	Wt. lbs.	Qty.
#50598	1/4"	6'	Zinc	0.73 lbs.	1
#50601	3/8"	6'	Zinc	1.76 lbs.	1
#50604	1/2"	6'	Zinc	3.20 lbs.	1
#50607	5/8"	6'	Zinc	5.06 lbs.	1
#80147	3/4"	6'	Zinc	7.44 lbs.	1
#80148	7/8"	6'	Zinc	10.26 lbs.	1
#80149	1"	6'	Zinc	13.44 lbs.	1

Item #	Size	Length	Finish	Wt. lbs.	Qty.
#50597	1/4"	4'	Zinc	0.49 lbs.	1
#50600	3/8"	4'	Zinc	1.17 lbs.	1
#50603	1/2"	4'	Zinc	2.13 lbs.	1
#50606	5/8"	4'	Zinc	3.37 lbs.	1
#80144	3/4"	4'	Zinc	4.96 lbs.	1
#80145	7/8"	4'	Zinc	6.84 lbs.	1
#80146	1"	4'	Zinc	8.96 lbs.	1

Item #	Size	Length	Finish	Wt. lbs.	Qty.
#50599	1/4"	10'	Zinc	1.22 lbs.	1
#50602	3/8"	10'	Zinc	2.93 lbs.	1
#50605	1/2"	10'	Zinc	5.33 lbs.	1
#50608	5/8"	10'	Zinc	8.43 lbs.	1
#50671	3/4"	10'	Zinc	12.35 lbs.	1
#50672	7/8"	10'	Zinc	17.05 lbs.	1
#50673	1"	10'	Zinc	22.31 lbs.	1

Free Freight Does Not Apply to 10' Pieces



Round Bar - Cold Rolled

Item #	Size	Length	Finish	Wt. lbs.	Qty.
#48304	3/8"	2'	Bare	0.75 lbs.	1
#48306	3/8"	4'	Bare	1.50 lbs.	1
#48307	1/2"	2'	Bare	1.31 lbs.	1
#48309	1/2"	4'	Bare	2.62 lbs.	1
#48310	3/4"	2'	Bare	3.00 lbs.	1
#48312	3/4"	4'	Bare	6.00 lbs.	1
#80800	7/8"	2'	Bare	4.00 lbs.	1

Round Bar - Hot Rolled

Item #	Size	Length	Finish	Wt. lbs.	Qty.
#48313	3/8"	2'	Bare	0.75 lbs.	1
#48315	3/8"	4'	Bare	1.50 lbs.	1
#48316	1/2"	2'	Bare	1.34 lbs.	1
#48318	1/2"	4'	Bare	2.68 lbs.	1
#48319	3/4"	2'	Bare	3.00 lbs.	1
#48321	3/4"	4'	Bare	6.00 lbs.	1



Round Tubing- 14ga

Item #	Size	Length	Finish	Wt. lbs.	Qty.
#48352	1.25" O.D.	2'	Bare	1.81 lbs.	1
#48354	1.25" O.D.	4'	Bare	3.62 lbs.	1
#48355	1.50" O.D.	2'	Bare	2.20 lbs.	1
#48357	1.50" O.D.	4'	Bare	4.39 lbs.	1



Expanded Metal

Item #	Size	Length	Finish	Wt. lbs.	Qty.
#47904	3/4" x #9	12" x 24"	Bare	3.30 lbs.	2
#47905	1/2" x #13	12" x 24"	Bare	3.30 lbs.	2



Rebar - Grade 60

Item #	Size	Length	Finish	Wt. lbs.	Qty.
#48358	1/2"	2'	Bare	1.34 lbs.	10
#48360	1/2"	4'	Bare	2.67 lbs.	10

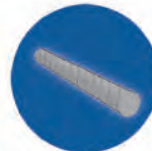

Stair Step

Item #	Size (Length x Width)	Thickness	Finish	Wt. lbs.	Qty.
#49196	40" x 11"	1/8"	Bare	22.20 lbs.	1



Square Tubing - 16ga

Item #	Size	Length	Finish	Wt. lbs.	Qty.
#48322	0.50" x 0.50"	2'	Bare	0.73 lbs.	1
#48324	0.50" x 0.50"	4'	Bare	1.46 lbs.	1
#48325	0.75" x 0.75"	2'	Bare	1.15 lbs.	1
#48327	0.75" x 0.75"	4'	Bare	2.31 lbs.	1
#48328	1.00" x 1.00"	2'	Bare	1.58 lbs.	1
#48330	1.00" x 1.00"	4'	Bare	3.16 lbs.	1
#48331	1.25" x 1.25"	2'	Bare	2.07 lbs.	1
#48333	1.25" x 1.25"	4'	Bare	4.14 lbs.	1
#48334	1.50" x 1.50"	2'	Bare	2.44 lbs.	1
#48336	1.50" x 1.50"	4'	Bare	4.88 lbs.	1

Square Tubing - 11ga

Item #	Size	Length	Finish	Wt. lbs.	Qty.
#48337	1.00" x 1.00"	2'	Bare	2.80 lbs.	1
#48339	1.00" x 1.00"	4'	Bare	5.60 lbs.	1
#48340	1.25" x 1.25"	2'	Bare	3.58 lbs.	1
#48342	1.25" x 1.25"	4'	Bare	7.16 lbs.	1
#48343	1.50" x 1.50"	2'	Bare	4.36 lbs.	1
#48345	1.50" x 1.50"	4'	Bare	8.72 lbs.	1

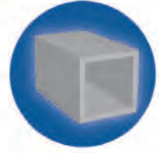

Square Bar - Cold Rolled

Item #	Size	Length	Finish	Wt. lbs.	Qty.
#48295	3/8"	2'	Bare	0.96 lbs.	1
#48297	3/8"	4'	Bare	1.91 lbs.	1
#48298	1/2"	2'	Bare	1.66 lbs.	1
#48300	1/2"	4'	Bare	3.40 lbs.	1
#48301	3/4"	2'	Bare	3.77 lbs.	1
#48303	3/4"	4'	Bare	7.65 lbs.	1

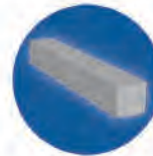

Rectangular Tubing - 14ga

Item #	Size	Length	Finish	Wt. lbs.	Qty.
#48346	2" x 1"	2'	Bare	2.83 lbs.	1
#48348	2" x 1"	4'	Bare	5.67 lbs.	1

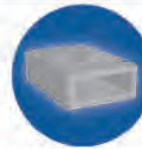

Flat Bar - 1/8"

Item #	Size	Length	Finish	Wt. lbs.	Qty.
#48271	1.00"	2'	Bare	0.85 lbs.	1
#48273	1.00"	4'	Bare	1.70 lbs.	1
#48274	1.50"	2'	Bare	1.28 lbs.	1
#48276	1.50"	4'	Bare	2.55 lbs.	1
#48277	2.00"	2'	Bare	1.70 lbs.	1
#48279	2.00"	4'	Bare	3.40 lbs.	1
#48280	3.00"	2'	Bare	2.55 lbs.	1
#48282	3.00"	4'	Bare	5.10 lbs.	1

Flat Bar - 1/4"

Item #	Size	Length	Finish	Wt. lbs.	Qty.
#48283	1.00"	2'	Bare	1.70 lbs.	1
#48285	1.00"	4'	Bare	3.40 lbs.	1
#48286	1.50"	2'	Bare	2.55 lbs.	1
#48288	1.50"	4'	Bare	5.10 lbs.	1
#48289	2.00"	2'	Bare	3.40 lbs.	1
#48291	2.00"	4'	Bare	6.80 lbs.	1
#48292	3.00"	2'	Bare	5.10 lbs.	1
#48294	3.00"	4'	Bare	10.20 lbs.	1

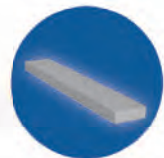

Visit us at
www.springcreekproducts.com

Angle Iron - 1/8"

Item #	Size	Length	Finish	Wt. lbs.	Qty.
#48247	1.00" x 1.00"	2'	Bare	1.60 lbs.	1
#48249	1.00" x 1.00"	4'	Bare	3.20 lbs.	1
#48250	1.25" x 1.25"	2'	Bare	2.02 lbs.	1
#48252	1.25" x 1.25"	4'	Bare	4.04 lbs.	1
#48253	1.50" x 1.50"	2'	Bare	2.46 lbs.	1
#48255	1.50" x 1.50"	4'	Bare	4.92 lbs.	1

Angle Iron - 3/16"

Item #	Size	Length	Finish	Wt. lbs.	Qty.
#48259	1.00" x 1.00"	2'	Bare	2.32 lbs.	1
#48261	1.00" x 1.00"	4'	Bare	4.64 lbs.	1
#48262	1.25" x 1.25"	2'	Bare	2.96 lbs.	1
#48264	1.25" x 1.25"	4'	Bare	5.92 lbs.	1
#48265	1.50" x 1.50"	2'	Bare	3.60 lbs.	1
#48267	1.50" x 1.50"	4'	Bare	7.20 lbs.	1

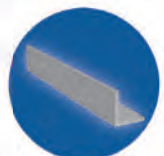

Malco® Turbo Shear Heavy-Duty

Item #	Type	Model #	Wt. lbs.	Qty.
#47853	Turbo Shear	TSHD	2.60 lbs.	4
#49148	Replacement Blades	TSHDRB	2.60 lbs.	1



Malco® Fencing Pliers

Item #	Size	Model #	Wt. lbs.	Qty.
#49154	8"	FP1	1.00 lbs.	4
#49155	10"	FP2	1.00 lbs.	4



Magnetic Pick Up Tool

Item #	Wt. lbs.	Qty.
#50188	0.10 lbs.	36



6-in-1 Screwdriver

Item #	Wt. lbs.	Qty.
#48164	0.27 lbs.	12



Punch Set - Numbers

Item #	Wt. lbs.	Qty.
#50469	0.80 lbs.	5



Magnetic Hex Nutsetters

Item #	Size	Wt. lbs.	Qty.
#80079	1/4"	0.05 lbs.	100
#80080	5/16"	0.06 lbs.	100
#80081	3/8"	0.08 lbs.	100



String And Reel - Pink

Item #	Wt. lbs.	Qty.
#50587	0.58 lbs.	15



Chalk Line With String Reel

Item #	Wt. lbs.	Qty.
#80704	0.67 lbs.	12



Spring Creek™ Tape Measures

Item #	Size	Type	Wt. lbs.	Qty.
#47898	25' x 1"	Magnet	0.66 lbs.	6
#47899	25' x 1"	No Magnet - Rubber Coated	0.66 lbs.	6
#47900	33' x 1"	Magnet	0.77 lbs.	6
#47901	33' x 1"	No Magnet - Rubber Coated	0.77 lbs.	6



Magnet Style



Durable, non-slip, rubber coated ABS case for easy grip.

New

Bora Portamate Speedhorses

Item #	Type	Wt. lbs.	Qty.
#81052	Single	23.0 lbs.	1
#81046	Double	46.0 lbs.	2



Collapsible for easy storage and traveling.

Sheet Metal Gauge

Item #	Gauges	Finish	Wt. lbs.	Qty.
#50446	0-36	Stainless Steel	0.10 lbs.	25



Welding Fillet Gauge

Item #	Finish	Wt. lbs.	Qty.
#50445	Stainless Steel	0.35 lbs.	10



Post Level

Item #	Size	Finish	Wt. lbs.	Qty.
#80336	9"	Plastic	0.15 lbs.	1



Torpedo Level

Item #	Size	Finish	Wt. lbs.	Qty.
#50447	9"	Plastic	0.15 lbs.	1



Locking "C" Clamps

Item #	Size	Swivel	Wt. lbs.	Qty.
#70055	6"	No	1.62 lbs.	6
#80327	6"	Yes	0.62 lbs.	1



Adjustable - "C" Clamps

Item #	Size	Wt. lbs.	Qty.
#49862	6"	2.37 lbs.	1
#80326	8"	3.75 lbs.	1



Tinner Snips

Item #	Size	Wt. lbs.	Qty.
#80334	10"	1.40 lbs.	1
#80335	12"	2.10 lbs.	1



Lock Jaw Pliers

Item #	Size	Wt. lbs.	Qty.
#80333	10"	1.00 lbs.	1



Fence Pliers

Item #	Size	Wt. lbs.	Qty.
#80332	10"	1.00 lbs.	1



Aviation Snips

Item #	Style	Color	Wt. lbs.	Qty.
#80133	Right	Green	0.88 lbs.	6
#80134	Left	Red	0.88 lbs.	6



Adjust-O™ Magnet Squares

Item #	Size (Height x Width)	Wt. lbs.	Qty.
#80744	4-3/8" x 3-3/4"	1.01 lbs.	1
#80745	5-7/8" x 5-1/8"	2.15 lbs.	1



Mini Magnet

Item #	Size (Height x Width)	Wt. lbs.	Qty.
#80743	2-5/16" x 2"	0.74 lbs.	1



Inside/Outside Magnets

Item #	Type	Size (Height x Width)	Wt. lbs.	Qty.
#80741	Original	6-1/2" x 4-3/8"	1.70 lbs.	1
#80740	Adjustable	3-15/16" x 5-15/16"	1.70 lbs.	1



Original



Adjustable



Magnetic Grasshopper

Item #	Wt. lbs.	Qty.
#80732	0.76 lbs.	1



Portable Magvise

Item #	Wt. lbs.	Qty.
#80763	1.66 lbs.	1



Grounding Magnetics

Item #	AMP	Wt. lbs.	Qty.
#80736	300	1.14 lbs.	1
#80737	500	1.67 lbs.	1



Ground Hog Pliers

Item #	Wt. lbs.	Qty.
#80738	2.63 lbs.	1



Locking C-Clamps - Round Tip

Item #	Size	Opening	Wt. lbs.	Qty.
#80752	7"	2-3/16"	0.59 lbs.	1
#80750	11-7/8"	4"	2.09 lbs.	1



Locking C-Clamps - Swivel Tip

Item #	Size	Opening	Wt. lbs.	Qty.
#80753	7-3/8"	2-3/16"	0.65 lbs.	1
#80751	12-1/4"	4"	2.24 lbs.	1



Utility Clamp Accessory Packs

Item #	Fits (Clamp Models)	Wt. lbs.	Qty.
#80764	UE, UF, UG	0.57 lbs.	1
#80765	UM, UP	0.91 lbs.	1



Utility Clamps

Item #	Size (Opening x Thickness)	Clamp Pressure	Stop	Wt. lbs.	Qty.
#80754	4-1/2" x 5/8"	500 lbs.	Ring	1.03 lbs.	1
#80755	6-1/2" x 5/8"	500 lbs.	Ring	1.11 lbs.	1
#80756	8-1/2" x 5/8"	500 lbs.	Ring	1.19 lbs.	1
#80757	6-1/2" x 7/8"	1,000 lbs.	Spring	2.48 lbs.	1
#80758	12-1/2" x 1"	1,200 lbs.	Spring	4.14 lbs.	1



Utility Clamp Kit

Item #	Size (Opening x Thickness)	Clamp Pressure	Stop	Wt. lbs.	Qty.
#80759	8-1/2" x 1"	1,200 lbs.	Spring	3.60 lbs.	1



Heavy-Duty Utility Clamps

Item #	Size (Opening)	Wt. lbs.	Qty.
#80760	10-1/2"	6.12 lbs.	1
#80761	12-1/2"	6.75 lbs.	1
#80762	20-1/2"	8.38 lbs.	1



Magtabs

Item #	Style	Size (Height x Width)	Wt. lbs.	Qty.
#80739	Standard	2-1/2" x 3-13/16"	0.46 lbs.	1
#80742	Jumbo	4" x 5-3/16"	1.28 lbs.	1



Magnetic V-Pads Kit

Item #	Wt. lbs.	Qty.
#80746	0.91 lbs.	1

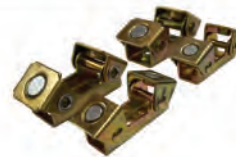

Adjustable Pipe Pliers

Item #	Size	Fits Pipe	Wt. lbs.	Qty.
#80748	9"	1" - 2"	0.93 lbs.	1
#80747	14-1/4"	1-1/2" - 2-1/2"	2.67 lbs.	1



Mig Pliers

Item #	Size	Wt. lbs.	Qty.
#80749	9-1/2"	0.74 lbs.	1



Maintenance File Set

Item #	6" Items	8" Items	10" Items	Wt. lbs.	Qty.
#80036	Slim Taper	Flat Smooth Half Round Bastard 4-In-1 Shoe Rasp	Flat Bastard Flat Smooth Mill Bastard Half Round Bastard Round Bastard	5.3 lbs.	1



Mercer® Ceraflame 2

Item #	Diameter x Arbor	Grit	Wt. lbs.	Qty.
#80039	4-1/2" x 7/8"	60	0.01 lbs.	20



RZR Cermet Steel Blades

Item #	Size	Teeth	Max RPM	Wt. lbs.	Qty.
<i>New</i> #80899	5-3/8" x 20mm	26	6,000	0.35 lbs.	1
<i>New</i> #80900	6-1/2" x 5/8"	32	6,000	0.55 lbs.	1
<i>New</i> #80901	7" x 20mm	36	5,800	0.70 lbs.	1
#80790	7-1/4" x 5/8"	36	5,800	0.79 lbs.	1
<i>New</i> #80902	7-1/4" x 20mm	36	5,800	0.75 lbs.	1
<i>New</i> #80903	8" x 5/8"	40	4,500	1.05 lbs.	1
<i>New</i> #80904	9" x 1"	44	3,500	1.50 lbs.	1
<i>New</i> #80905	12" x 1"	54	1,700	2.70 lbs.	1
#80787	14" x 1"	64	1,500	3.29 lbs.	1



Mercer® Steel Thunder Carbide Blades

Item #	Size	Teeth	Max RPM	Wt. lbs.	Qty.
#80283	7-1/4" x 5/8"	36	5,800	0.86 lbs.	5
#80284	8" x 5/8"	48	5,800	1.06 lbs.	5
#80285	9" x 1"	48	5,800	1.42 lbs.	5
#80286	14" x 1"	72	1,800	2.01 lbs.	5



Mercer® ZSpeed T1 Cut-Off Wheels

Item #	Diameter x Width x Arbor	Max RPM	Wt. lbs.	Qty.
#80017	4-1/2" x .045 x 7/8"	13,300	1.00 lbs.	50
#80018	5" x .045 x 7/8"	12,200	1.00 lbs.	25
#80019	6" x .045 x 7/8"	10,200	1.00 lbs.	25

Mercer® ZSpeed T27 Cut-Off Wheels

Item #	Diameter x Width x Arbor	Max RPM	Wt. lbs.	Qty.
#80020	4-1/2" x .045 x 7/8"	13,300	1.00 lbs.	50
#80021	4-1/2" x .045 x 5/8"-11	13,300	1.00 lbs.	20
#80022	5" x .045 x 7/8"	12,200	1.00 lbs.	25
#80023	5" x .045" x 5/8"-11	12,200	1.00 lbs.	20
#80024	6" x .045 x 7/8"	8,500	1.00 lbs.	25
#80025	6" x .045 x 5/8"-11	8,500	1.00 lbs.	10



Carbo White™ Grind Wheel

Item #	Diameter x Width x Arbor	Type	Wt. lbs.	Qty.
#47779	4-1/2" x 1/4" x 7/8"	No Hub	0.94 lbs.	20



Metal Devil® 7" Metal-Cutting Circular Saw

11 amps, 1080 watts, 3500 RPM

Item #	Wt. lbs.	Qty.
#47948	16.00 lbs.	1

Free Freight Does Not Apply



Metal Devil®

Metal Devil® 9" Metal-Cutting Circular Saw

15 amps, 1800 watts, 2500 RPM

Item #	Wt. lbs.	Qty.
#47949	24.00 lbs.	1

Free Freight Does Not Apply



Metal Devil®

Metal Devil® 14" Metal-Cutting Circular Saw

15 amps, 1800 watts, 1300 RPM

Item #	Wt. lbs.	Qty.
#47950	55.00 lbs.	1

Free Freight Does Not Apply



Metal Devil®

Metal Devil® Cutting Blades

Item #	Size	Tooth	Arbor	Type	Fits	Wt. lbs.	Qty.
#47951	7"	40	20 mm	Steel	#47948	1.00 lbs.	1
#48029	7-1/4"	40	5/8" KO	Steel	#47948	1.00 lbs.	1



Metal Devil®

Metal Devil® Cutting Blades

Item #	Size	Tooth	Arbor	Wt. lbs.	Qty.
#48363	8"	42	5/8"	1.10 lbs.	1
#48362	8"	48	5/8"	1.10 lbs.	1



Metal Devil®

Metal Devil® Cutting Blade

Item #	Size	Tooth	Arbor	Type	Fits	Wt. lbs.	Qty.
#47952	9"	48	1"	Steel	#47949	2.50 lbs.	1



Metal Devil®

Metal Devil® Cutting Blade

Item #	Size	Tooth	Arbor	Type	Fits	Wt. lbs.	Qty.
#47953	14"	66	1"	Steel	#47950	4.50 lbs.	1



Metal Devil®

New **Mechanics Length Drill Bits - Brute XL28**

Single / Clamshell

Bulk

Item #	Size	Wt. lbs.	Qty.	Item #	Size	Wt. lbs.	Qty.
#80938	1/16	0.06 lbs.	1	#80909	1/16	0.04 lbs.	12
#80939	5/64	0.06 lbs.	1	#80910	5/64	0.06 lbs.	12
#80940	3/32	0.06 lbs.	1	#80911	3/32	0.07 lbs.	12
#80941	7/64	0.07 lbs.	1	#80912	7/64	0.09 lbs.	12
#80942	1/8	0.07 lbs.	1	#80913	1/8	0.10 lbs.	12
#80943	9/64	0.08 lbs.	1	#80914	9/64	0.13 lbs.	12
#80944	5/32	0.08 lbs.	1	#80915	5/32	0.17 lbs.	12
#80945	11/64	0.07 lbs.	1	#80916	11/64	0.21 lbs.	12
#80946	3/16	0.07 lbs.	1	#80917	3/16	0.25 lbs.	12
#80947	13/64	0.07 lbs.	1	#80918	13/64	0.29 lbs.	12
#80948	7/32	0.09 lbs.	1	#80919	7/32	0.30 lbs.	12
#80949	15/64	0.09 lbs.	1	#80920	15/64	0.35 lbs.	12
#80950	1/4	0.09 lbs.	1	#80921	1/4	0.40 lbs.	12
#80951	17/64	0.10 lbs.	1	#80922	17/64	0.50 lbs.	12
#80952	9/32	0.10 lbs.	2	#80923	9/32	0.60 lbs.	12
#80953	19/64	0.11 lbs.	1	#80924	19/64	0.40 lbs.	6
#80954	5/16	0.12 lbs.	1	#80925	5/16	0.35 lbs.	6
#80955	21/64	0.13 lbs.	1	#80926	21/64	0.48 lbs.	6
#80956	11/32	0.13 lbs.	1	#80927	11/32	0.54 lbs.	6
#80957	23/64	0.14 lbs.	1	#80928	23/64	0.50 lbs.	6
#80958	3/8	0.12 lbs.	1	#80929	3/8	0.64 lbs.	6
#80959	25/64	0.16 lbs.	1	#80930	25/64	0.12 lbs.	6
#80960	13/32	0.18 lbs.	1	#80931	13/32	0.78 lbs.	6
#80961	27/64	0.18 lbs.	1	#80932	27/64	0.80 lbs.	6
#80962	7/16	0.19 lbs.	1	#80933	7/16	0.85 lbs.	6
#80963	29/64	0.20 lbs.	1	#80934	29/64	0.85 lbs.	6
#80964	15/32	0.26 lbs.	1	#80935	15/32	1.05 lbs.	6
#80965	31/64	0.23 lbs.	1	#80936	31/64	1.10 lbs.	6
#80966	1/2	0.24 lbs.	1	#80937	1/2	1.18 lbs.	6



Twister-XL28 Bits

Item #	Wt. lbs.	Qty.
<i>New</i> #80848	2.31 lbs.	1



Tap And Die Kit

Item #	Kit Includes	Wt. lbs.	Qty.
<i>New</i> #80847	17 Machine Screws 17 Machine Screws 1 Die stock 2 Tap Wrenches 1 Thread Pitch Gauge 1 Screwdriver	3.35 lbs.	1



New

Combination Drill And Tap Bits

Item #	Size	Wt. lbs.	Qty.
#80832	6 - 32	0.06 lbs.	1
#80833	8 - 32	0.07 lbs.	1
#80834	10 - 24	0.07 lbs.	1
#80835	10 - 32	0.07 lbs.	1
#80836	12 - 24	0.07 lbs.	1
#80837	1/4 - 20	0.07 lbs.	1
#80838	1/4 - 28	0.07 lbs.	1
#80839	5/16 - 18	0.08 lbs.	1
#80840	5/16 - 24	0.08 lbs.	1
#80841	3/8 - 16	0.11 lbs.	1
#80842	3/8 - 24	0.12 lbs.	1
#80843	7/16 - 14	0.13 lbs.	1
#80844	7/16 - 20	0.13 lbs.	1
#80845	1/2 - 13	0.14 lbs.	1
#80846	1/2 - 20	0.14 lbs.	1



New

Rotary Hammer Bits - SDS Plus

Item #	Size	Wt. lbs.	Qty.
#80873	3/16" x 4" x 6"	0.10 lbs.	1
#80874	1/4" x 2" x 4"	0.10 lbs.	1
#80875	1/4" x 4" x 6"	0.11 lbs.	1
#80876	1/4" x 6" x 8"	0.10 lbs.	1
#80877	5/16" x 4" x 6"	0.13 lbs.	1
#80878	3/8" x 4" x 6"	0.16 lbs.	1
#80879	3/8" x 10" x 12"	0.25 lbs.	1
#80880	1/2" x 4" x 6"	0.18 lbs.	1
#80881	1/2" x 10" x 12"	0.35 lbs.	1
#80882	5/8" x 6" x 8"	0.30 lbs.	1
#80883	5/8" x 10" x 12"	0.45 lbs.	1
#80884	3/4" x 6" x 8"	0.40 lbs.	1
#80885	3/4" x 10" x 12"	0.75 lbs.	1
#80886	7/8" x 6" x 8"	0.55 lbs.	1
#80887	7/8" x 10" x 12"	0.95 lbs.	1
#80888	1" x 8" x 10"	1.00 lbs.	1



New

Hex Step Drill Bits - 1/4" Shank

Item #	Type	Steps	Wt. lbs.	Qty.
#80865	HEX 1	13 - 1/8" to 1/2"	0.10 lbs.	1
#80866	HEX 13	13 - 1/4" to 1-1/8"	0.25 lbs.	1
#80867	HEX 3	9 - 1/4" to 3/4"	0.15 lbs.	1
#80868	HEX 4	12 - 3/16" to 7/8"	0.15 lbs.	1



Step Reamer Set

Item #	Wt. lbs.	Qty.
<i>New</i> #80849	1.55 lbs.	1



New

Rotary Hammer Bits With Stop

Item #	Size	Wt. lbs.	Qty.
#80895	3/8" x 1-1/16"	0.20 lbs.	1
#80866	1/2" x 13/16"	0.25 lbs.	1
#80897	5/8" x 1-1/16"	0.30 lbs.	1
#80898	5/8" x 2-1/16"	0.35 lbs.	1



New

Rotary Rebar Cutters

Item #	Size	Wt. lbs.	Qty.
#80889	1/2"	0.70 lbs.	1
#80890	5/8"	0.90 lbs.	1
#80891	3/4"	1.25 lbs.	1
#80892	7/8"	1.20 lbs.	1
#80893	1"	1.35 lbs.	1
#80894	1-1/8"	1.55 lbs.	1



New

Annular Cutter Bits

Item #	Size	Wt. lbs.	Qty.
#80851	7/16"	0.20 lbs.	1
#80852	1/2"	0.25 lbs.	1
#80853	9/16"	0.25 lbs.	1
#80854	5/8"	0.30 lbs.	1
#80855	11/16"	0.30 lbs.	1
#80856	3/4"	0.30 lbs.	1
#80857	13/16"	0.40 lbs.	1
#80858	7/8"	0.40 lbs.	1
#80859	15/16"	0.50 lbs.	1
#80860	1"	0.35 lbs.	1
#80861	1-1/16"	0.45 lbs.	1
#80862	1-1/4"	0.50 lbs.	1
#80863	1-1/2"	0.60 lbs.	1
#80864	2"	0.85 lbs.	1



New

Magnetic Drill Presses

Item #	Type	Wt. lbs.	Qty.
#80850	MiniBrute	37.30 lbs.	1
#80967	MightiBrute	42.30 lbs.	1



Black Knives

Item #	Size	Coating	Handle	Wt. lbs.	Qty.
#48636	(A) 4-1/2"	Black	Stainless Steel	0.38 lbs.	10
#48637	(B) 4-1/2"	Black	Stainless Steel	0.35 lbs.	10
#48638	(C) 4-1/2"	Black	Stainless Steel	0.35 lbs.	10
#48640	(D) 4-1/2"	Black	Stainless Steel	0.30 lbs.	10

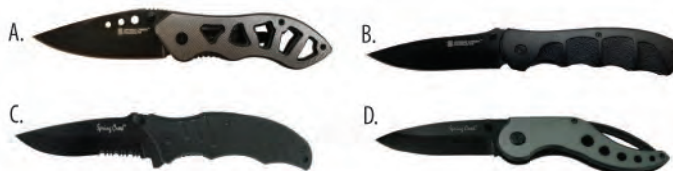

Pakkawood Inlay Knives

Item #	Size	Coating	Handle	Wt. lbs.	Qty.
#48647	(A) 4-1/2"	Satin	Stainless	0.32 lbs.	10
#48648	(B) 4-1/2"	Satin	Stainless	0.32 lbs.	10
#48649	(C) 4-1/2"	Satin	Stainless	0.32 lbs.	10
#48650	(D) 4-1/2"	Satin	Light burl wood	0.32 lbs.	10
#48651	(E) 4-1/2"	Satin	Light burl wood	0.32 lbs.	10



Camo Knives

Item #	Size	Coating	Handle	Wt. lbs.	Qty.
#48641	(A) 4-1/2"	Camo	Stainless Steel	0.32 lbs.	10
#48642	(B) 4"	Black	Stainless Steel	0.28 lbs.	10
#48643	(C) 4-1/2"	Black	Stainless Steel	0.30 lbs.	10
#48644	(D) 4-1/2"	Black	Stainless Steel	0.30 lbs.	10
#48645	(E) 5"	Camo	Stainless Steel	0.30 lbs.	10
#48646	(F) 4-1/2"	Black	Stainless Steel	0.32 lbs.	10



Hunting Knife

Item #	Size	Finish	Wt. lbs.	Qty.
#48652	8.85"	Stainless Steel	0.50 lbs.	1



NEW ARRIVALS

Shop Now

See the newest additions on our website,
www.springcreekproducts.com



Multi-Tools

Item #	Size	Type	Includes	Wt. lbs.	Qty.
#48633	(A) 3.2" - Black	4 in 1	Pliers, knife blade, bottle opener, carabiner	0.23 lbs.	12
#48634	(B) 3.8" - Metallic Gray	9 in 1	Pliers, screwdriver, knife blade, file, saws, bottle opener	0.58 lbs.	6
#48635	(C) 4.1" - Black	9 in 1	Pliers, screwdriver, knife blade, file, saws, bottle opener	0.63 lbs.	6

Turnbuckles - Eye And Eye

Item #	Size (Diameter x Body)	Length (Closed / Open)		Finish	Wt. lbs.	Qty.
#49183	1/2" x 6"	13-3/4"	19-1/4"	HDG	1.35 lbs.	20
#49088	1/2" x 9"	17-1/4"	24-11/16"	HDG	1.73 lbs.	20
#49093	1/2" x 12"	19-7/8"	31-7/16"	HDG	2.06 lbs.	20



Turnbuckles - Eye And Eye

Item #	Size (Diameter x Body)	Length (Closed / Open)		Finish	Wt. lbs.	Qty.
#48873	3/16" x 5-1/2"	8-1/2"	10-5/8"	Zinc	0.09 lbs.	10
#48874	1/4" x 2-1/2"	5-1/2"	7-5/8"	Zinc	0.13 lbs.	50
#48875	5/16" x 2-7/8"	6"	8-1/2"	Zinc	0.22 lbs.	50



Turnbuckles - Hook And Eye

Item #	Size (Diameter x Body)	Length (Closed / Open)		Finish	Wt. lbs.	Qty.
#49798	3/8" x 6"	12-1/8"	17-7/16"	HDG	0.75 lbs.	20
#49182	1/2" x 6"	17-1/4"	19-3/4"	HDG	1.61 lbs.	20
#49090	1/2" x 9"	16-1/2"	24-7/8"	HDG	1.90 lbs.	20
#49095	1/2" x 12-1/4"	20"	31-5/8"	HDG	2.27 lbs.	20
#49797	5/8" x 9"	18-1/2"	26-7/8"	HDG	3.04 lbs.	10



Turnbuckles - Hook And Eye

Item #	Size (Diameter x Body)	Length (Closed / Open)		Finish	Wt. lbs.	Qty.
#48869	3/16" x 1-5/8"	4-1/2"	5-7/8"	Zinc	0.06 lbs.	10
#48870	1/4" x 2-1/2"	5-1/2"	7-5/8"	Zinc	0.13 lbs.	50
#48871	5/16" x 2-7/8"	6-3/4"	9-1/8"	Zinc	0.24 lbs.	10
#48872	3/8" x 3"	7"	9-1/2"	Zinc	0.34 lbs.	20



Turnbuckles - Hook And Hook

Item #	Size (Diameter x Body)	Length (Closed / Open)		Finish	Wt. lbs.	Qty.
#49087	1/2" x 9"	16-1/2"	24-3/4"	HDG	1.93 lbs.	20
#49092	1/2" x 12"	19-3/4"	31-1/2"	HDG	2.36 lbs.	20



Turnbuckles - Jaw And Eye

Item #	Size (Diameter x Body)	Length (Closed / Open)		Finish	Wt. lbs.	Qty.
#49091	1/2" x 9"	16-7/8"	25-1/4"	HDG	1.75 lbs.	20
#49096	1/2" x 12"	19-1/2"	31"	HDG	2.04 lbs.	20



Turnbuckles - Jaw And Jaw

Item #	Size (Diameter x Body)	Length (Closed / Open)		Finish	Wt. lbs.	Qty.
#49089	1/2" x 9"	16-1/2"	24-7/8"	HDG	1.85 lbs.	20
#49094	1/2" x 12"	19-1/4"	32-1/2"	HDG	2.20 lbs.	20



Screw Eye

Item #	Size (Diameter x Shaft)	Overall Length	Thread Length	Eye I.D.	Finish	Wt. lbs.	Qty.
#48868	1/4" x 4"	5"	1-3/4"	1/2"	Zinc	0.08 lbs.	10



Eyebolts

Item #	Size (Diameter x Shaft)	Overall Length	Thread Length	Eye I.D.	Finish	Wt. lbs.	Qty.
#48853	1/4" x 4"	5"	2-3/8"	1/2"	HDG	0.09 lbs.	10
#48854	5/16" x 2-1/4"	3-1/2"	1-1/2"	5/8"	HDG	0.12 lbs.	10
#48855	5/16" x 4-1/8"	5-7/16"	2-1/2"	5/8"	HDG	0.14 lbs.	10
#48856	3/8" x 2-1/2"	4"	1-1/2"	3/4"	HDG	0.20 lbs.	10
#48857	5/16" x 4-1/2"	6"	2-5/8"	3/4"	HDG	0.23 lbs.	10
#48858	3/8" x 6"	7-1/2"	2-1/2"	3/4"	HDG	0.31 lbs.	10
#48859	1/2" x 6-1/4"	8-3/8"	3-1/8"	1"	HDG	0.66 lbs.	20
#48860	1/2" x 8-1/4"	10-1/4"	3"	1"	HDG	0.76 lbs.	10
#48861	1/2" x 10"	12"	3"	1"	HDG	0.78 lbs.	10
#49873	1/2" x 12"	14-1/4"	3-1/8"	1"	HDG	0.76 lbs.	20



Eyebolts

Item #	Size (Diameter x Shaft)	Overall Length	Thread Length	Eye I.D.	Finish	Wt. lbs.	Qty.
#50121	1/2" x 3-7/8"	6"	3"	1-3/16"	Zinc	0.42 lbs.	10
#80089	1/2" x 9-7/8"	12"	3"	1-3/16"	Zinc	0.69 lbs.	10
#48862	1/2" x 12-1/4"	14-1/2"	3-7/8"	1-3/16"	Zinc	0.79 lbs.	10



S-Hooks

Item #	Size (Diameter x Length)	Finish	Wt. lbs.	Qty.
#48877	1/8" x 1-1/4"	Zinc	0.01 lbs.	100
#49918	5/32" x 1-1/4"	Zinc	0.02 lbs.	100
#48880	5/32" x 1-1/2"	Zinc	0.02 lbs.	100
#48881	3/16" x 1-3/4"	Zinc	0.04 lbs.	20
#48882	1/4" x 2-3/8"	Zinc	0.06 lbs.	20
#49919	5/16" x 2-5/8"	Zinc	0.17 lbs.	20
#48884	5/16" x 3-1/8"	Zinc	0.17 lbs.	20
#48885	3/8" x 4"	Zinc	0.29 lbs.	50



Quick Links

Item #	Size	Finish	Wt. lbs.	Qty.
#48896	1/4"	Zinc	0.08 lbs.	10
#48897	5/16"	Zinc	0.17 lbs.	10
#48898	3/8"	Zinc	0.29 lbs.	10
#48899	1/2"	Zinc	0.55 lbs.	10



Spring Hooks

Item #	Size	Finish	Wt. lbs.	Qty.
#48954	3/16"	Zinc	0.06 lbs.	10
#48900	1/4"	Zinc	0.06 lbs.	10
#48901	5/16"	Zinc	0.14 lbs.	10
#48902	3/8"	Zinc	0.28 lbs.	10
#48903	1/2"	Zinc	0.55 lbs.	10



U-Bolts

Item #	Size	Finish	Wt. lbs.	Qty.
#48915	1"	Zinc	0.09 lbs.	10
#48916	1-3/8"	Zinc	0.17 lbs.	20
#48917	1-3/4"	Zinc	0.21 lbs.	20
#48918	2"	Zinc	0.34 lbs.	10
#48919	2-1/2"	Zinc	0.34 lbs.	10
#48920	3"	Zinc	0.44 lbs.	20



Screw Pin Anchor Shackles

Item #	Size	Finish	Wt. lbs.	Qty.
#48891	1/4"	HDG	0.11 lbs.	10
#48892	5/16"	HDG	0.19 lbs.	10
#48893	3/8"	HDG	0.29 lbs.	10
#48894	1/2"	HDG	0.66 lbs.	10
#48895	5/8"	HDG	1.37 lbs.	10
#49126	3/4"	HDG	2.19 lbs.	10
#49127	1"	HDG	5.20 lbs.	10



Wire Rope Clips

Item #	Size	Finish	Wt. lbs.	Qty.
#48904	1/8"	Zinc	0.03 lbs.	20
#48905	3/16"	Zinc	0.06 lbs.	10
#48906	1/4"	Zinc	0.06 lbs.	20
#48907	5/16"	Zinc	0.13 lbs.	20
#48908	3/8"	Zinc	0.21 lbs.	20
#50426	3/8"	HDG	0.46 lbs.	50
#49097	1/2"	Zinc	0.40 lbs.	20
#80072	9/16"	Zinc	0.45 lbs.	20
#49128	5/8"	Zinc	0.59 lbs.	10



Coupling Links

Item #	Size	Grade	W.L.L.	Finish	Wt. lbs.	Qty.
#80045	9/23"	80	3,500 lbs.	Painted	0.26 lbs.	50
#49690	5/16"	100	5,700 lbs.	Painted	0.42 lbs.	50



Wire Rope Thimbles

Item #	Size	Finish	Wt. lbs.	Qty.
#48886	3/16"	Zinc	0.03 lbs.	25
#48887	1/4"	Zinc	0.03 lbs.	25
#48888	5/16"	Zinc	0.04 lbs.	20
#48890	1/2"	Zinc	0.11 lbs.	100



Steel Ring

Item #	Size	Finish	Wt. lbs.	Qty.
#49403	2"	Nickel	0.08 lbs.	20



Swivel Eye Snaps

Item #	Size (Eye x Length)	Finish	Wt. lbs.	Qty.
#49401	3/8" x 3"	Bronze	1.01 lbs.	10
#49901	3/4" x 3-11/16"	Nickel	0.09 lbs.	10



Double Chain Snaps

Item #	Size	Finish	Wt. lbs.	Qty.
#49398	1/4" x 3-1/2"	Bronze	0.10 lbs.	10
#49395	1/4" x 3-1/2"	Nickel	0.10 lbs.	50
#49396	3/8" x 4"	Nickel	0.10 lbs.	10
#49399	3/8" x 4-5/8"	Bronze	0.16 lbs.	10
#49397	3/8" x 4-5/8"	Nickel	0.16 lbs.	20



Snap Hook With Open Eye

Item #	Size (Eye x Length)	Finish	Wt. lbs.	Qty.
#49899	3/8" x 3-1/2"	Zinc	0.13 lbs.	10



Swivel Snaps

Item #	Type	Size	Finish	Wt. lbs.	Qty.
#49402	Trigger	3/8" x 2-1/2"	Bronze	1.01 lbs.	10
#49400	Loop	3/8" x 3-1/8"	Nickel	0.12 lbs.	10



Trigger



Loop

J-Bolt Cane

Item #	Size	Finish	Wt. lbs.	Qty.
#80111	4-1/2"	Zinc	0.31 lbs.	100



Hitch Pin - Bent

Item #	Size (Diameter x Length)	Finish	Wt. lbs.	Qty.
<i>New</i> #80725	5/8" x 3"	Zinc	0.52 lbs.	50



Hitch Pins

Item #	Size (Diameter x Usable Length)	Finish	Wt. lbs.	Qty.
#49942	1/2" x 3-1/2"	Zinc	0.41 lbs.	10
#49944	5/8" x 4-1/2"	Zinc	0.69 lbs.	1
#49945	5/8" x 6"	Zinc	0.81 lbs.	5
#49948	3/4" x 4-1/2"	Zinc	0.91 lbs.	1
#49949	3/4" x 6"	Zinc	1.13 lbs.	50
#49953	1" x 6"	Zinc	1.88 lbs.	12



Hitch Pins With Weld Handle

Item #	Size (Diameter x Usable Length)	Finish	Wt. lbs.	Qty.
#50453	3/4" x 5-1/8"	Zinc	1.10 lbs.	5
#50454	3/4" x 6-7/8"	Zinc	1.20 lbs.	5
#50455	7/8" x 5-1/8"	Zinc	1.40 lbs.	5
#50456	1" x 5-1/8"	Zinc	1.80 lbs.	5
#50457	1" x 6-7/8"	Zinc	2.00 lbs.	5
#50458	1-1/8" x 5-1/8"	Zinc	2.10 lbs.	5
#50459	1-1/8" x 6-7/8"	Zinc	2.50 lbs.	5
#50460	1-1/4" x 6-7/8"	Zinc	3.00 lbs.	5



Assorted Cotter Pin Kit

Item #	Size (Width x Usable Length)	Pieces	Finish	Wt. lbs.	Qty.
#50450	1/8" x 1-1/2"	100	Zinc	5.05 lbs.	10
	5/32" x 1-1/2"	48			
	5/32" x 2-1/2"	56			
	3/16" x 2"	56			
	1/4" x 2-1/2"	15			
	5/16" x 4"	10			
	3/8" x 3-1/8"	5			

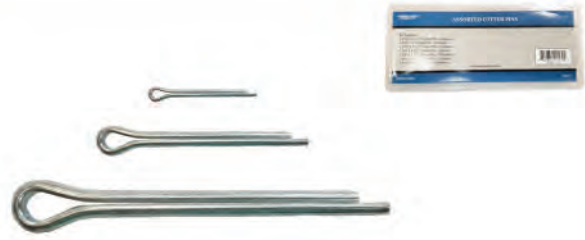

Snapper Pins - Round

Item #	Size (Diameter x Usable Length)	Finish	Wt. lbs.	Qty.
#50102	1/4" x 1-3/4"	Zinc	0.14 lbs.	20
#49854	1/4" x 2-3/4"	Zinc	0.06 lbs.	40
#49857	5/16" x 2"	Zinc	0.09 lbs.	30
#49858	3/8" x 2-3/4"	Zinc	0.14 lbs.	30



Snapper Pins - Square

Item #	Size (Diameter x Usable Length)	Finish	Wt. lbs.	Qty.
#49852	1/4" x 1-3/4"	Zinc	0.06 lbs.	50
#49856	1/4" x 2-1/2"	Zinc	0.06 lbs.	1
#49853	5/16" x 2-1/4"	Zinc	0.13 lbs.	50
#49855	3/8" x 2-1/4"	Zinc	0.09 lbs.	1



Assorted Snapper Pin Kit

Item #	Size (Diameter x Usable Length)	Style	Pieces	Finish	Wt. lbs.	Qty.
#50448	1/4" x 2-1/4"	Round	10	Zinc	2.45 lbs.	10
	3/8" x 2-3/8"	Round	5			
	5/16" x 2-5/16"	Square	7			



Linchpins

Item #	Size (Diameter x Usable Length)	Finish	Wt. lbs.	Qty.
#49956	1/4" x 1-3/4"	Zinc	0.04 lbs.	100
#49957	3/16" x 1-5/8"	Zinc	0.03 lbs.	20
#49958	5/16" x 1-3/4"	Zinc	0.06 lbs.	100
#49959	7/16" x 2-5/8"	Zinc	0.16 lbs.	100
#49960	7/16" x 2-1/2" HD	Zinc	0.13 lbs.	100



Assorted Linchpin Kit

Item #	Size (Diameter x Usable Length)	Pieces	Finish	Wt. lbs.	Qty.
#50449	1/4" x 1-7/16"	18	Zinc	3.20 lbs.	10
	3/16" x 1-1/4"	16			
	5/16" x 1-1/2"	6			
	7/16" x 1-1/2"	10			



R-Pin

Item #	Size (Diameter x Length)	Finish	Wt. lbs.	Qty.
#50524	5/8" x 2-3/8"	Zinc	0.01 lbs.	50



Assorted R-Pin Kit

Item #	Size (Diameter x Length)	Pieces	Finish	Wt. lbs.	Qty.
#50452	3/32" x 2-7/16"	30	Zinc	3.20 lbs.	10
	1/16" x 2-3/8"	20			
	1/8" x 2-13/16"	20			
	5/32" x 3"	20			
	3/16" x 3-3/8"	8			
	5/16" x 5-5/16"	3			



Assorted Double R-Pin Kit

Item #	Size (Diameter x Length)	Pieces	Finish	Wt. lbs.	Qty.
#50451	3/32" x 3"	28	Zinc	2.55 lbs.	10
	5/32" x 3-1/4"	13			
	3/16" x 4"	9			



Tie Loops

Item #	Size (Inside Dia. x Dia.)	Leg Length	Type	Shape	Finish	Wt. lbs.	Qty.
#49886	2" x 1/2"	2-1/4"	Aluminium-Bolt On	Round	Bare	0.15 lbs.	50
#49889	2" x 1/2"	2"	Steel - Weld On	Round	Bare	0.13 lbs.	50
#49888	2-1/4" x 3/8"	1-7/8"	Steel - Weld On	Square	Bare	0.34 lbs.	50
#49963	2-1/4" x 3/8"	3/4"	Steel - Weld On	Square	Bare	0.34 lbs.	50
#50067	5" x 1/2"	2-1/4"	Steel - Weld On	Square	Bare	0.55 lbs.	50



Weld On Safety Chain Clips

Item #	Size (Length x Diameter)	Finish	Wt. lbs.	Qty.
#50012	4" x 3/8"	Bare	0.15 lbs.	50
#50013	4" x 7/16"	Bare	0.19 lbs.	220
#50014	6" x 1/2"	Bare	0.36 lbs.	120



Chain Retainers

Item #	Pin Size	Overall Length	Fits	Finish	Wt. lbs.	Qty.
#80026	3/8"	3-7/8"	5/16"	Bare	0.61 lbs.	40
#80027	1/2"	4-1/2"	3/8"	Bare	0.97 lbs.	30



Aircraft Cable 7 x 19

Item #	Size	Finish	Wt. lbs.	Qty.
#49365	1/8" x 500'	Galvanized	14.50 lbs.	1
#49366	3/16" x 500'	Galvanized	32.50 lbs.	1
#49367	1/4" x 500'	Galvanized	55.00 lbs.	1
#49368	5/16" x 250'	Galvanized	43.30 lbs.	1
#50122	5/16" x 500'	Galvanized	86.00 lbs.	1
#49369	3/8" x 250'	Galvanized	60.80 lbs.	1



Weld On Grab Hooks - Grade 43

Item #	Size	Dimension (Length x Width x Height)	Working L.L.	MBS	Finish	Wt. lbs.	Qty.
#48850	5/16"	2" x 5/8" x 2-1/2"	3,900 lbs.	11,700 lbs.	Bare	0.49 lbs.	20
#48848	3/8"	2-3/8" x 3/4" x 3"	5,400 lbs.	16,200 lbs.	Bare	0.87 lbs.	20
#48847	1/2"	3-1/8" x 1" x 4"	9,200 lbs.	27,886 lbs.	Bare	1.70 lbs.	20



Twisted Link Chain #4

Item #	Size	Length	Finish	Wt. lbs.	Qty.
#80229	1/8"	200'	Zinc	25.00 lbs.	1



Square Pails And Drums Of Chain

Item #	Size	Length	Proof	Finish	Wt. lbs.	Qty.
#50001	1/8"	270'	30	Zinc	54.00 lbs.	Pail
#49016	3/16"	150'	30	Zinc	53.90 lbs.	Pail
#50142		1,500'			515.88 lbs.	Drum
#80768	3/16"	150'	30	Bare	53.90 lbs.	Pail
#49017	1/4"	100'	30	Zinc	56.00 lbs.	Pail
#80633		800'			532.00 lbs.	Drum
#80769	1/4"	100'	30	Bare	56.00 lbs.	Pail
#49018	5/16"	75'	30	Zinc	61.00 lbs.	Pail
#49019	3/8"	45'	30	Zinc	54.00 lbs.	Pail
#50002	1/2"	40'	30	Zinc	97.00 lbs.	Pail
#50143		200'			475.00 lbs.	Drum
#50144	5/8"	150'	30	Zinc	520.00 lbs.	Drum



70 Proof Transport Chains

Item #	Size	Length	Hook	Finish	Wt. lbs.	Qty.
#47896	5/16"	20'	Yes	Chromate	21.50 lbs.	1
#49659	5/16"	275'	No	Chromate	240.00 lbs.	Drum
#47897	3/8"	20'	Yes	Chromate	34.00 lbs.	1
#49205	3/8"	63'	No	Chromate	90.00 lbs.	Pail



5/16" x 20' Shown

Clevis Hooks

Item #	Size	Grade	Max Load Limit	Finish	Wt. lbs.	Qty.
#48046	1/4"	70	3,500 lbs.	Zinc	0.36 lbs.	50
#49895	5/16"	43	3,900 lbs.	Zinc	0.78 lbs.	100
#48047	5/16"	70	4,500 lbs.	Zinc	0.76 lbs.	20
#49896	3/8"	43	5,400 lbs.	Zinc	1.13 lbs.	100
#48048	3/8"	70	7,100 lbs.	Zinc	1.01 lbs.	20
#48049	1/2"	70	12,000 lbs.	Zinc	2.24 lbs.	10



Clevis Slip Hooks And Chain

Item #	Size	Grade	Chain	Latch	Finish	Wt. lbs.	Qty.
#80393	5/16"	30	Yes	Yes	Zinc	3.10 lbs.	10
#49890	5/16"	43	No	No	Zinc	0.88 lbs.	10
#49893	5/16"	43	No	Yes	Zinc	0.88 lbs.	10
#49922	5/16"	43	Yes	Yes	Zinc	3.13 lbs.	10
#49891	3/8"	43	No	No	Zinc	1.31 lbs.	25
#49894	3/8"	43	No	Yes	Zinc	1.38 lbs.	10
#49923	3/8"	43	Yes	Yes	Zinc	4.90 lbs.	10



No Latch



Latch



Latch and 35° Chain

Lashing Rings - Bolt On

Item #	Size	Working L.L.	MBS	Dimension (Length x Height)	Finish	Wt. lbs.	Qty.
#49988	1/4"	700 lbs.	N/A	1-1/2" x 2-1/2"	Bare	0.13 lbs.	1000
#49362	1/2"	4,000 lbs.	12,000 lbs.	3-1/4" x 5"	Bare	1.00 lbs.	20



Horseshoe Stall Tie-Down

Item #	Size	Finish	Wt. lbs.	Qty.
#47690	4-3/8" x 6" x 1-1/4"	Bare	1.53 lbs.	25



Lashing Ring - Weld On

Item #	Size	Working L.L.	Dimension (Length x Height)	Finish	Wt. lbs.	Qty.
#50110	3/8"	2,000	3-5/16" x 2-3/4"	Zinc	0.45 lbs.	20



Bent Lashing Rings - Weld On

Item #	Size	Working L.L.	Inner Diameter (Width x Height)	Inner Diameter (Width x Height)	Finish	Wt. lbs.	Qty.
#50345	1"	15,586 lbs.	3" x 3-1/2"	5" x 5-1/2"	Bare	4.46 lbs.	8 / box
#80398							256 / crate



Rotating Lashing Ring - Weld On

Item #	Size	Working L.L.	Inner Diameter (Width x Height)	Outer Diameter (Width x Height)	Finish	Wt. lbs.	Qty.
#80231	1"	15,586 lbs.	3" x 2"	5" x 6"	Bare	7.37 lbs.	5



Lashing Rings - Weld On

Item #	Size	Working L.L.	MBS	Inner Diameter (Width x Height)	Outer Diameter (Width x Height)	Finish	Wt. lbs.	Qty.
#48195	1/2"	4,000 lbs.	12,000 lbs.	2-1/4" x 2-1/2"	3-1/4" x 3-1/2"	Bare	0.94 lbs.	20/box
#80460								500/crate
#48196	5/8"	6,000 lbs.	18,000 lbs.	3" x 3"	4-1/4" x 4-1/4"	Bare	1.90 lbs.	20/box
#80193								500/crate
#48197	3/4"	8,833 lbs.	26,500 lbs.	3" x 3"	4-1/2" x 4-1/2"	Bare	2.50 lbs.	10
#48198	1"	15,666 lbs.	47,000 lbs.	3" x 3"	5" x 5"	Bare	4.16 lbs.	10
#50341	1"	15,586 lbs.	47,000 lbs.	3" x 4"	5" x 6"	Bare	4.65 lbs.	8/box
#80364								256/crate



Lashing Rings - Bolt On

Item #	Type	Working L.L.	MBS	Dimension (Length x Height)	Finish	Wt. lbs.	Qty.
#49431	(A) 1/4" Square	N/A	N/A	4" x 3-3/4"	Zinc	1.00 lbs.	1
#49989	(B) 1/4" Oval	1,200 lbs.	1,200 lbs.	3-1/2" x 5"	Zinc	0.41 lbs.	100
#49990	(C) 1/4" Round with Plastic Trim	500 lbs.	N/A	4"	Zinc	0.31 lbs.	100
#49991	(D) 5/16" Square	6,000 lbs.	6,000 lbs.	4-1/2" x 4-7/8"	Zinc	1.13 lbs.	25
#49992	(E) Rotating Ring	6,000 lbs.	6,000 lbs.	6-1/16"	Zinc	2.28 lbs.	20

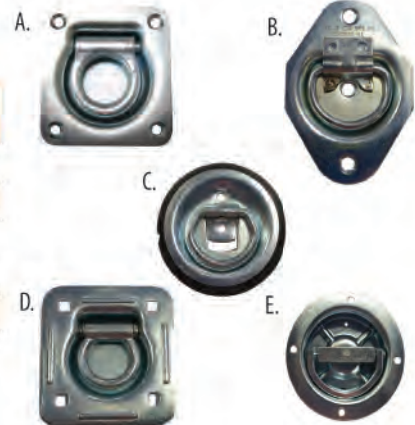

RIGGING WINCHES / BINDERS

Winch Bars

Item #	Type	Finish	Wt. lbs.	Qty.
#47891	Combination	Chrome	6.44 lbs.	10
#47892	Standard	Chrome	5.07 lbs.	10



Combination

Portable Webbing Winches

Item #	Style	Finish	Wt. lbs.	Qty.
#47893	Bolt On	Powder Coat	8.84 lbs.	5
#80088	Weld On	Powder Coat	8.60 lbs.	5



Bolt On



Weld On

Lever Load Binder

Item #	Accommodates	Break Strength	Finish	Wt. lbs.	Qty.
#47894	5/16" - 3/8"	19,000 lbs.	Powder Coat	8.29 lbs.	6



Ratchet Binder

Item #	Accommodates	Break Strength	Finish	Wt. lbs.	Qty.
#47895	5/16" - 3/8"	19,000 lbs.	Powder Coat	10.61 lbs.	4



Yellow Poly Hollow Braid Ropes

Item #	Size	Length	Wt. lbs.	Qty.
#50212	1/4"	100'	0.74 lbs.	6
#50213	3/8"	50'	0.69 lbs.	6

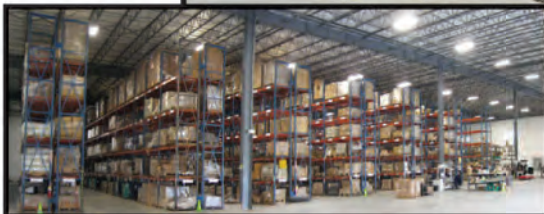

*We ship all over the
U.S.A.*



Ratchet Tie-Down Straps With Extension Chain

Item #	Size	Break Strength	Working L.L.	Wt. lbs.	Qty.
#49497	2" x 27'	10,000 lbs.	3,333 lbs.	7.00 lbs.	8



Winch Strap With Extension Chain

Item #	Size	Break Strength	Working L.L.	Wt. lbs.	Qty.
#49499	4" x 30'	16,200 lbs.	5,400 lbs.	6.00 lbs.	5



Ratchet Tie-Down Straps - Flat Hooks

Item #	Size	Break Strength	Working L.L.	Wt. lbs.	Qty.
#47890	2" x 27'	10,000 lbs.	3,333 lbs.	5.38 lbs.	10



Ratchet Tie-Down Straps - Double J Hooks

Item #	Size	Break Strength	Working L.L.	Wt. lbs.	Qty.
#47889	2" x 27'	10,000 lbs.	3,333 lbs.	4.94 lbs.	10



New & Improved!

Winch Strap with Flat Hooks

- Break strength: 16,200 lbs.
- Working load limit: 5,400 lbs.
- D.O.T. Compliant

We spent years developing this strap with our supplier and are confident that it is as good or better than any other comparable strap on the market!



Item #	Size	Wt. lbs.	Qty.
#47888	4" x 30'	4.80 lbs.	4

Ratchet Tie-Down Straps "S" Hooks 1" x 12'

Item #	Color	Break Strength	Working L.L.	Wt. lbs.	Qty.
#47882	Blue	1,200 lbs.	400 lbs.	2.00 lbs.	12
#48419	Red	1,200 lbs.	400 lbs.	2.00 lbs.	12
#48421	Yellow	1,200 lbs.	400 lbs.	2.00 lbs.	12
#48422	Black	1,200 lbs.	400 lbs.	2.00 lbs.	12
#48423	Camo	1,200 lbs.	400 lbs.	2.00 lbs.	12



Ratchet Tie-Down Straps "S" Hooks 1" x 15'

Item #	Color	Break Strength	Working L.L.	Wt. lbs.	Qty.
#48429	Blue	3,000 lbs.	1,000 lbs.	4.06 lbs.	6
#48430	Red	3,000 lbs.	1,000 lbs.	4.06 lbs.	6
#48432	Yellow	3,000 lbs.	1,000 lbs.	4.06 lbs.	6
#48433	Black	3,000 lbs.	1,000 lbs.	4.06 lbs.	6
#48434	Camo	3,000 lbs.	1,000 lbs.	4.52 lbs.	6



PREMIER STEEL DOORS AND FRAMES



Metal Doors

- 20 gauge insulated
- Galvanized
- Heavy-duty reinforcements
- Non Handed

- #50030 - 3' with dead lock (#3070)
- #50033 - 3' without deadlock (#3070)

- #50035 - 4' without deadlock (#4070)

These items do not qualify for free freight



Door Knob

- Delaney Commercial Grade 2 Cylindrical Knobset
- Stainless Steel
- #50032 - Knob Lock

Metal Frames

- 16 gauge insulated
- Galvanized
- All frames include basic knob set

- #50031 - 4-1/4" without deadlock (#3070)

- #80631 - 6-1/4" with deadlock (#3070)
- #50037 - 6-1/4" without deadlock (#3070)
- #50038 - 6-1/4" without deadlock (#4070)

- #50039 - 8-1/4" with deadlock (#3070)

- #50054 - 8-1/4" without deadlock (#3070)
- #50055 - 8-1/4" without deadlock (#4070)

Free Freight Does Not Apply

Other items available for special order:

- Grade 1, 2, and 3 Locksets
- Deadbolts, Rim Cylinders, Deadlatch Mortise Locks
- Door Closers
- Exit Devices
- Hinges and Door Trim
- Doors and Frames

Tacky Tape

Item #	Size	Wt. lbs.	Qty.
#48525	3/32" x 3/8" x 45'	1.17 lbs.	48



Round Roof Jacks

Item #	Pipe Size	Base	Wt. lbs.	Qty.
#48523	2-1/4" x 4-3/4"	8"	0.52 lbs.	10
#48524	4-1/4" x 7-1/2"	11"	1.08 lbs.	10



#48523



#48524

Self Drill Screws (5/16" Hex Head Size)

#12-14 x 1"

Item #	Color	Wt. lbs.	Qty.
#48485	Plain	0.01 lbs.	250
#48486	Polar White	0.01 lbs.	250
#48487	Mocha Tan	0.01 lbs.	250
#48488	Light Stone	0.01 lbs.	250
#48489	Rustic Red	0.01 lbs.	250
#48490	Slate	0.01 lbs.	250
#48491	Brown	0.01 lbs.	250
#48492	Ash Grey	0.01 lbs.	250
#48493	Charcoal	0.01 lbs.	250
#48494	Hawaiian Blue	0.01 lbs.	250
#49026	Forest Green	0.01 lbs.	250



#14 x 7/8"

Item #	Color	Wt. lbs.	Qty.
#48495	Plain	0.01 lbs.	250
#48496	Polar White	0.01 lbs.	250
#48497	Mocha Tan	0.01 lbs.	250
#48498	Light Stone	0.01 lbs.	250
#48499	Rustic Red	0.01 lbs.	250
#48500	Slate	0.01 lbs.	250
#48501	Brown	0.01 lbs.	250
#48502	Ash Grey	0.01 lbs.	250
#48503	Charcoal	0.01 lbs.	250
#48504	Hawaiian Blue	0.01 lbs.	250
#49027	Forest Green	0.01 lbs.	250



Metal To Wood Screws

#10 x 1-1/2"

Item #	Color	Wt. lbs.	Qty.
#48505	Plain	0.01 lbs.	250
#48506	Polar White	0.01 lbs.	250
#48507	Mocha Tan	0.01 lbs.	250
#48508	Light Stone	0.01 lbs.	250
#48509	Rustic Red	0.01 lbs.	250
#48510	Slate	0.01 lbs.	250
#48511	Brown	0.01 lbs.	250
#48512	Ash Grey	0.01 lbs.	250
#48513	Charcoal	0.01 lbs.	250
#48514	Hawaiian Blue	0.01 lbs.	250



Color Choices



**Tones may vary from image

Hillside Washer 1/2"

Item #	Finish	Wt. lbs.	Qty.
#49794	Bare	0.35 lbs.	50



Nail Anchors

Item #	Size	Finish	Wt. lbs.	Qty.
#49884	1/4" x 1-1/4"	Bare	0.02 lbs.	100
#50015	1/4" x 1-1/2"	Bare	0.02 lbs.	100
#49997	1/4" x 2"	Bare	0.03 lbs.	100



Wedge Anchors

Item #	Size (Diameter x Length)	Minimum Embedment	Finish	Wt. lbs.	Qty.
#49877	3/8" x 2-3/4"	1-1/2"	Zinc	0.09 lbs.	100
#49878	1/2" x 4-1/4"	2-1/4"	Zinc	0.25 lbs.	25
#50228	1/2" x 7"	2-1/4"	Zinc	0.36 lbs.	25
#49880	5/8" x 6"	2-3/4"	Zinc	0.50 lbs.	25
#49881	3/4" x 4-3/4"	3-1/2"	Zinc	0.65 lbs.	20
#49883	3/4" x 7"	3-1/2"	Zinc	0.87 lbs.	10



NOTES: An appropriate factor of safety must be applied to the above ultimate values to determine the allowable loads for design purposes.

METAL BUILDING CLIPS / ANCHOR PLATES

Purlin Clips (Blank, No Holes)

Item #	Size (Length x Width)	Thickness	Finish	Wt. lbs.	Qty.
#80411	5" x 3"	10ga	Bare	0.58 lbs.	50 / box 500 / pallet
#45911	5" x 3"	10ga	Bare	0.58 lbs.	50 / box 500 / pallet
#80141	5" x 3"	3/16"	Bare	0.78 lbs.	40
<i>New</i> #80809	7" x 5"	10ga	Bare	1.36 lbs.	10
#80412	7" x 5"	3/16"	Bare	1.95 lbs.	10 / box 500 / pallet
#45912	7" x 5"	3/16"	Bare	1.95 lbs.	10 / box 500 / pallet
#80248	8-1/2" x 3"	3/16"	Bare	2.00 lbs.	10



Purlin Angle Clip

Item #	Size (Length x Width x Height)	Thickness	Finish	Wt. lbs.	Qty.
#80055	2-3/4" x 2" x 2"	10ga	Bare	0.37 lbs.	12

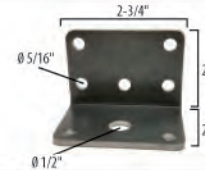

Purlin Chairs

Item #	Fits Size (Purlin)	Size (Length x Width x Height)	Thickness	Finish	Wt. lbs.	Qty.
#80053	1-1/2"	3" x 1-3/4" x 4-1/2"	10ga	Bare	0.65 lbs.	12
#80054	2"	3" x 2-5/16" x 4-1/2"	10ga	Bare	0.76 lbs.	12



Headed Weld Studs

Item #	Size	Pin Diameter	Head Size	Finish	Wt. lbs.	Qty.
#50058	4-1/8"	1/2"	1"	Bare	0.20 lbs.	50
#50059	6-1/8"	1/2"	1"	Bare	0.35 lbs.	50
#50511	8-3/16"	1/2"	1"	Bare	0.45 lbs.	100



Concrete J-Bolt Anchor Plates

Item #	Size (Square Plate)	Plate Thickness	Stud Number	Finish	Wt. lbs.	Qty.
#80082	4" x 4"	3/16"	2	Bare	2.21 lbs.	1
#49717	6" x 6"	3/16"	4	Bare	2.92 lbs.	1
#50585	6" x 6"	3/8"	4	Bare	4.65 lbs.	1
#80083	8" x 8"	3/8"	4	Bare	12.87 lbs.	1
#80084	6" x 12"	3/8"	6	Bare	20.28 lbs.	1



Concrete Weld Stud Anchor Plates

Item #	Size (Square Plate)	Plate Thickness	Studs	Stud Number	Finish	Wt. lbs.	Qty.
#50388	6" x 6"	3/8"	1/2" x 4-1/8"	4	Bare	4.90 lbs.	1
#49718	6" x 6"	3/8"	1/2" x 6"	4	Bare	5.35 lbs.	1
#49720	6" x 10"	3/8"	1/2" x 6"	4	Bare	7.90 lbs.	1
#49724	8" x 8"	3/8"	1/2" x 6"	4	Bare	8.82 lbs.	1
#49725	10" x 10"	3/8"	1/2" x 6"	4	Bare	12.2 lbs.	1

Item #	Size (Square Plate)	Plate Thickness	Studs	Stud Number	Finish	Wt. lbs.	Qty.
#49719	6" x 10"	3/8"	1/2" x 6"	6	Bare	7.90 lbs.	1
#49721	6" x 12"	3/8"	1/2" x 6"	6	Bare	9.90 lbs.	1
#49722	6" x 14"	3/8"	1/2" x 6"	6	Bare	10.90 lbs.	1
#49726	6" x 14"	1/2"	1/2" x 8"	6	Bare	14.90 lbs.	1
#49723	8" x 12"	3/8"	1/2" x 6"	6	Bare	13.50 lbs.	1
#49727	10" x 10"	1/2"	1/2" x 6"	6	Bare	16.60 lbs.	1



Specifications are subject to change without notice.

Base Punch Plates

Item #	Square	Hole (Suits bolt size)	Thickness	Finish	Wt. lbs.	Qty.
#49116	3"	3/8"	3/16"	Bare	0.40 lbs.	20
#49113	4"	3/8"	3/16"	Bare	0.74 lbs.	20
#50250	4"	7/16"	3/16"	Bare	0.73 lbs.	50
#50326	5"	3/8"	3/16"	Bare	1.30 lbs.	10
#50278	5"	3/8"	1/4"	Bare	1.60 lbs.	10
#50318	5"	1/2"	1/4"	Bare	1.57 lbs.	25
#49842	6"	1/2"	1/4"	Bare	2.09 lbs.	10
#49840	8"	9/16"	1/4"	Bare	4.38 lbs.	10
#80066	8"	9/16"	3/8"	Bare	6.70 lbs.	5
#80476	10"	9/16"	5/16"	Bare	9.63 lbs.	8

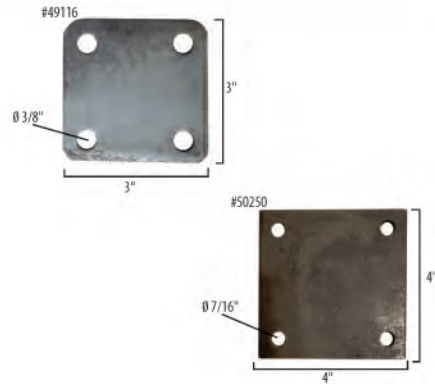

Sign Up To Order Online!



It's simple and easy! Place orders, view product information, prices, and invoices.

Contact your sales representative for more information at 866-651-6702

Check out our website: www.springcreekproducts.com



Anchor Bolts With Washers And Nuts

Item #	Size (Diameter x Length)	Style	Pintle	Finish	Wt. lbs.	Qty.
#48461	1/2" x 8"	2" Thread - 3 nuts/1 washer	2"	HDG	0.63 lbs.	20
#50570	5/8" x 12"	4" Thread - 2 nuts/2 washers	2"	Bare	1.20 lbs.	20
#48462	3/4" x 12"	4" Thread - 2 nuts/2 washers	3"	HDG	1.88 lbs.	20
#48463	3/4" x 12"	4" Thread - 2 nuts/2 washers	3"	Bare	1.82 lbs.	20
#80131	3/4" x 18"	4" Thread - 2 nuts/2 washers	3"	Bare	2.55 lbs.	10
#80132	3/4" x 24"	4" Thread - 2 nuts/2 washers	3"	Bare	3.20 lbs.	10



Square Anchor Sleeves

Item #	Size (Fits Into)	Gauge	Finish	Wt. lbs.	Qty.
#80457	3"	14ga, 11ga	Painted	4.20 lbs.	1
#80235	4"	14ga	Painted	6.30 lbs.	1
#80803	4"	11ga	Painted	6.81 lbs.	1



SHOP GEAR
EYE AND FACE PROTECTION

Lightweight Safety Glasses

Item #	Wt. lbs.	Qty.
#70190	0.07 lbs.	6



Octane™ Safety Glasses

Item #	Lens	Temple/Frame	Wt. lbs.	Qty.
#50024	Clear	Black	0.08 lbs.	12
#50025	Smoked	Black	0.08 lbs.	12
#50227	Smoked	Camo	0.08 lbs.	12



Inhibitor® NXT Safety Glasses

Item #	Lens	Temple/Frame	Wt. lbs.	Qty.
#50229	Clear	Clear	0.04 lbs.	12
#50230	Gray	Gray	0.04 lbs.	12



Commandos® Safety Glasses

Item #	Lens	Temple/Frame	Wt. lbs.	Qty.
#50231	Clear	Black	0.04 lbs.	12
#50232	Gray	Black	0.04 lbs.	12
#50233	Camo	Amber	0.04 lbs.	12



Boas® Safety Glasses

Item #	Lens	Temple/Frame	Wt. lbs.	Qty.
#49435	Clear	Smoke/Clear	0.07 lbs.	12
#49436	Clear	Clear/Clear	0.07 lbs.	12
#49437	Smoked	Smoke/Smoke	0.07 lbs.	12



SG-204-51 Safety Goggles

Item #	Wt. lbs.	Qty.
#47961	0.19 lbs.	20



WG-209-51 Safety Goggles

Item #	Wt. lbs.	Qty.
#70047	0.46 lbs.	10



Disposable Face Mask

Item #	Wt. lbs.	Qty.
#80418	0.42 lbs.	50



Face Shield – 8" x 12" Visor

Item #	Wt. lbs.	Qty.
#47963	0.53 lbs.	1



Ear Plugs

Item #	Type	Wt. lbs.	Qty.
#47995	No Cord	0.004 lbs.	200
#47996	Corded	0.005 lbs.	200



Ear Muff - Lightweight

Item #	Wt. lbs.	Qty.
#47989	0.35 lbs.	12



Premium Welding Glove 16"

Grade A leather, Kevlar® stitching

Item #	Size	Wt. lbs.	Qty. (Pairs)
#49685	Large	1.19 lbs.	10



Premium Welding Glove 14"

Grade A leather, Kevlar® stitching

Item #	Size	Wt. lbs.	Qty. (Pairs)
#49694	Large	0.67 lbs.	10



Econo Welding Glove 14"

Grade B-C leather

Item #	Size	Wt. lbs.	Qty. (Pairs)
#49695	Large	0.67 lbs.	10



Econo Mig Welding Glove 12"

Grade A-B leather

Item #	Size	Wt. lbs.	Qty. (Pairs)
#49688	Large	0.54 lbs.	10



New

Mig Welding Gloves

Kevlar® stitching

Item #	Style	Size	Wt. lbs.	Qty. (Pairs)
#81139	Fleece Lined	Large	0.63 lbs.	12
#81140	Fleece Lined	X-Large	0.70 lbs.	12
#81141	-	Large	0.36 lbs.	12
#81142	-	X-Large	0.39 lbs.	12



New

Stick Welding Gloves

Kevlar® stitching

Item #	Style	Size	Wt. lbs.	Qty. (Pairs)
#81133	Gold Grain	Large	0.64 lbs.	12
#81134	Gold Grain	X-Large	0.78 lbs.	12
#81135	Pearl Grain	Large	0.68 lbs.	12
#81136	Pearl Grain	X-Large	0.79 lbs.	12



New

Tig Welding Gloves

Kevlar® stitching

Item #	Size	Wt. lbs.	Qty. (Pairs)
#81137	Large	0.28 lbs.	12
#81138	X-Large	0.30 lbs.	12



New

Driver Gloves

Item #	Size	Wt. lbs.	Qty. (Pairs)
#81129	Medium	0.27 lbs.	12
#81130	Large	0.29 lbs.	12
#81131	X-Large	0.36 lbs.	12
#81132	XX-Large	0.37 lbs.	12



Spring Creek™ Pigskin Leather Driving Glove

Item #	Size	Wt. lbs.	Qty. (Pairs)
#50539	Medium	0.33 lbs.	12
#47816	Large	0.28 lbs.	12
#50540	X-Large	0.28 lbs.	12



Premium Work Glove Double Palm 11"

Grade A-B leather, Kevlar® stitching

Item #	Size	Wt. lbs.	Qty. (Pairs)
#50541	Medium	0.54 lbs.	12
#49686	Large	0.57 lbs.	12
#50542	X-Large	0.58 lbs.	12



Goat Skin Glove 10-1/2"

Grade A goat skin, Kevlar® stitching

Item #	Style	Size	Wt. lbs.	Qty. (Pairs)
#50104	3M Insulated	X-Large	0.42 lbs.	12
#50115	Non-Insulated	X-Large	0.33 lbs.	12



Econo Work Glove Single Palm 10-1/2"

Grade B-C leather

Item #	Wt. lbs.	Qty. (Pairs)
#49687	0.49 lbs.	12



Oil Field Glove Double Palm 18 oz.

Item #	Wt. lbs.	Qty. (Pairs)
#48663	0.19 lbs.	12



Shop And Towel Rack

Item #	Size (Length x Width x Height)	Finish	Wt. lbs.	Qty.
#80234	20" x 4" x 11"	Painted	2.40 lbs.	1



High-Pressure Spray Gun

Item #	Size	Wt. lbs.	Qty.
#50016	1 Quart	2.30 lbs.	10



Steel Strapping

Item #	Size	Strength	WLL	Wt. lbs.	Pallet
#49219	3/4"	.025" high	2,770 lbs.	100 lbs.	13



Steel Strap Clips

Item #	Size	Wt. lbs.	Qty.
#48089	3/4"	0.01 lbs.	250



2 Mil Tape

Item #	Size	Wt. lbs.	Qty.
#49420	2" x 110 Yards	0.75 lbs.	36



Torque Stretch Film

Item #	Size	Wt. lbs.	Qty.
#49383	18" x 1,500'	5.20 lbs.	4



Spring Creek™ Products

Check out some of our customers' projects!

Share your projects with us at sales@springcreekproducts.com!



Installing pipe fence is easy with our saddle cut pipe guides and cable clips!



Keep those pesky critters out of your garden! We have the hinges, latches, and post caps you need!



Our variety of hinges, latches, and post caps are perfect for building gates or fences for your property!



Get creative with our tank heads, expanded metal, and cut to length section to build your backyard fire pit!

Let **Spring Creek™ Products** customize a display for you!
Minimum order amount required.



Assorted Welding Displays
Mix and match wire, rods, and accessories.



Bale Spear Display
This display holds all the accessories you need for hauling round bales in one convenient location.

Item #	Wt. lbs.	Qty.
#50003	37.50 lbs.	1



Cut-To-Length Materials
Custom designed to your specifications.
• All material is deburred, cleaned, color-coded, barcoded and packaged
• Available in 2 foot or 4 foot sections

Item #	Wt. lbs.	Qty.
#80130	267.00 lbs.	1

Eye-catching | Profit Generator | Organized | Space Saver | Easy Inventory Tracking



Hardware Display
This display houses multiple items in one convenient location. Perfect for one-stop shopping. Call a sales representative for more details.



Letters and Numbers Display



Rigging Display



Gondola Display Unit - Metal Backing

- Freestanding display
- Available in 2ft or 4ft width
- Shelves are adjustable
- Can be combined for longer width

Item #	Color	Size	Wt. lbs.	Qty.
#80243	Beige	2'	38.00 lbs.	1
#80244	Black	2'	38.00 lbs.	1
#49669	Black	4'	75.00 lbs.	1
#50152	Beige	4'	75.00 lbs.	1



Tip Bins And Cabinet

- Bins - 5" x 5-5/8" x 7-1/2" (4 Total)
- Break resistant containers in each cabinet
- Tip open to a 45°
- Removable containers
- Molded handle, Slots for labels

Polystyrene Cabinet:
7-1/2" height x 23-5/8" length x 6-5/8" depth.
Can stack or wall mount

Bin Divider

5" L x 1/8" W x 7-1/2" H

Item #	Type	Wt. lbs.	Qty.
#49207	Tip Bin	7.00 lbs.	1
#49216	Bin Divider	0.20 lbs.	1
#49860	Replacement Bins	0.20 lbs.	1



Peg Hooks

These hooks are great for any display! They have 8" of usable space to hang a variety of product.

Item #	Wt. lbs.	Qty.
#80325	0.10 lbs.	1



Adjustable Replacement Feet For Gondola Display

Item #	Wt. lbs.	Qty.
#80724	0.12 lbs.	1



Self Serve Bags

These bags are labeled with Item #, QTY, and Price for easy check out.

Item #	Type	Wt. lbs.	Qty.
#80987	Roll	8.77 lbs.	1,000 / Roll
#80988	Holder	1.75 lbs.	1

Stackable Bins

Highly durable injection-molded plastic. Front, back, and side grips. Slot for labels, wide stacking ledges. Anti-slide locks - prevent from shifting. Rust and Corrosion resistant



Blue Stackable Bin - Small

Outer dimension: 5" H x 5-1/2" W x 11" D
Bin load: 30 lbs., 1 divider slot



Blue Stackable Bin - Medium

Outer dimension: 7" H x 8" W x 15" D
Bin load: 60 lbs., 3 divider slots



Blue Stackable Bin - Large

Outer dimension: 7" H x 16-1/2" W x 14-1/4" D
Bin load: 75 lbs., 3 divider slots

Item #	Type	Wt. lbs.	Qty.
#50210	Small - Blue	0.75 lbs.	1
#50211	Medium - Blue	1.17 lbs.	1
#50241	Large - Blue	2.65 lbs.	1
#50384	Small - Dividers	0.17 lbs.	1
#50248	Large Dividers	0.44 lbs.	1



Champion Drill Display

Counter top Drill Display, with or without drill bits.

Item #	Size	Wt. lbs.	Qty.
#80906	12-1/2" x 15" x 14"	15.0 lbs.	1
#80907	12-1/2" x 15" x 14"	25.0 lbs.	1

*Display includes all drill bits.

ABRASIVES

Brushes.....	65
Chop Saw.....	64
Cut-Off Wheel.....	63-65,84
Flap Disc.....	62-63
Grindwheel.....	64-65,85
Wire Wheels.....	65

AIRCRAFT CABLE.....95

ANCHOR PLATES

J-Rod.....	102
Studs.....	102

ANGLE IRON.....79

BALE SPEARS.....39

BALL MOUNTS.....33

BALUSTER COLLARS.....52

BBQ ACCESSORIES

BBQ Thermometers.....	69
Grill Pan.....	68
BBQ Wheels.....	22-23,69
Metal Art Cookers.....	68

BINDERS

Lever Load.....	98
Ratchet.....	98

BLADES, SAW

Circular Saws.....	84-85
Cutting Blades.....	84-85

BRUSHES

Wire Brush.....	57
Wire Wheel.....	65

BODY PROTECTION

Ears Muffs/Plugs.....	104
Eyeware.....	55,104
Face Shield.....	54,104
Gloves.....	105-106
Welding Helmets.....	54

BOLTS

Anchor.....	103
Cane.....	42
Carriage.....	19
Eyebolt.....	91
J-Bolt.....	18
Lag.....	18
U-Bolt.....	92

CABLE GRIPS.....43

CAST IRON

Braces.....	27
Bottle Opener.....	27
Collar.....	52
Finial/Spear.....	52-53
Handles.....	25,30
Hinges.....	31
Horseshoe.....	26
Latches.....	30
Post Ball/Caps.....	49

Wheels.....	22-23,69
-------------	----------

CASTERS

Caster.....	24
Cast Iron/BBQ.....	22-23,69
Rubber Guide Roller.....	22
V-Groove.....	22

CHAIN/ACCESSORIES

Clevis Hooks.....	96
Grab Hooks.....	95
Keeper/Chain.....	5,44
Pails/Drum.....	96
Transport.....	96

CHAIN LINK FENCE ACC...20-21

CHIPPING HAMMERS.....57

CHUTE PARTS.....46

CLAMPS

C Clamps.....	55,81-83
L Clamps.....	83
Ground.....	56
Panel.....	20,46
Toggle.....	3,36

CLIPS

Cable.....	45-46
Continuous.....	45-46
Fence.....	45-46
Pipe.....	45
Rail.....	31

COTTER PINS.....94

CUT-TO-LENGTH

Angle Iron.....	79
Flat Bar.....	79
Square Bar.....	79
Square/Rectangular Tube.....	79
Round Bar.....	78
Threaded Rod.....	78

DECORATIVE

Bottle Openers.....	27
Bottle Cap Catchers.....	27
Coat Hooks.....	27
Braces.....	27
Brackets.....	27
Handles.....	25,28,30
Horseshoes.....	26

DISPLAYS.....108-109

DOOR/GATE HARDWARE

Doors/Knobs.....	100
Door Track.....	23
Handle.....	25,28,30
Gate Latch.....	1-6,30,36
Gate Wheel.....	22-24
Guide Rollers.....	22
V-Groove Wheel.....	22

DOUBLE R-PINS.....95

ELBOWS, PIPE.....47

EXPANDED METAL.....78

FARM/RANCH

Fence Clips.....	45-46
Chain Keeper/Chain.....	5,44
Chute/Panel Parts.....	20-21,46
Drop Pin.....	21,46
Lag Bolt.....	46
Panel Clamp/Adapter.....	20,46
Panel Connectors.....	20,45-47
Pipe Panel Pals.....	51
Plastic Plugs.....	50
Post Caps.....	48-50
Striker Plate.....	6

FENCE CLIPS.....45-46

FENCING TOOLS

Fence Pliers.....	80-81
Fence Stretchers.....	43
T-Post Driver.....	42
T-Post Puller.....	42
Wire Gripper.....	43

FINIALS.....52-53

FIRE PITS.....68

FLAT BAR.....79

FLAT CAPS.....48-50

GATE WHEEL.....22-24

GLOVES

Oilfield.....	106
Leather.....	105-106
Welding.....	105

GRAB HOOKS.....95-96

GRINDWHEELS.....64-65,85

HANDRAIL.....31

HAND TOOLS

Brushes.....	57
Chipping Hammers.....	57
Cutters.....	81
Pliers.....	55,80-81,83
Snips.....	81

HANDLES.....25,28,30

HELMETS.....54

HILLSIDE WASHERS.....101

HINGES

Adjustable, Barrel.....	17
Barrel.....	9-11,67
Bat Wing.....	12
Bullet.....	8-9,67
Flag.....	11
Flat.....	7
Gate.....	7-19
Hasp & Staple.....	17
Heavy-duty.....	13-15
J-Bolt.....	18-19
Lag Pin.....	18
Male/Female.....	18-19

Piano Hinge.....	7
------------------	---

Pipe Sleeve.....	14-15
Ring Adapters.....	15
Round.....	10
Spring.....	12
Square.....	11,67
Strap.....	11,16
Tear Drop.....	13
Winged.....	12

HINGE ADAPTERS.....15

HITCHPINS.....32,93

HOOKS

Clevis.....	96
Coat.....	27
Grab.....	95
Rope.....	27
S.....	32,91
Trailer.....	32
Turnbuckle.....	90

HORSE STALL CHANNEL.....38

JACK STANDS.....66

J-BOLTS.....18

KEYPAD MOUNTS.....40

KITS

Bird Bath Kits.....	68
Firepit Weld Kits.....	68
Tractor Seat Bar Stool Kit.....	26
Trailer Bar Kits.....	36

KNIVES.....89

LANDSCAPE.....39

LASHING RINGS.....37,96-97

LATCHES, GATE

Bar Gate.....	1-3
Bolt.....	2-4
Compression.....	6
Cowboy.....	5,42
Gravity.....	5
Horseshoe.....	1
Lockable.....	3-6
Slam Action.....	3
Spring.....	1-3
Stall.....	3,36
Toggle Clamp.....	3,36
Trailer Bar Kits.....	36
Two-Way Lockable.....	5

LATCH KEEPERS.....6

LETTERS/NUMBERS.....77

LIGHTS.....34-35

LINCHPINS.....94

LOCK BOXES.....51

MALCO®.....80

METAL ART

Cooking.....	68
Letter/Number.....	77

Tractor Seats.....26	REBAR.....78	Brushes.....57
METAL DEVIL®.....85	RECTANGULAR TUBE.....79	Cable Connector.....56
METAL DOORS.....100	RIGGING HARDWARE	Clamp.....55-56
MOUNTING BRACKETS	Chain.....96	Cut-To-Length.....78-79
Braces.....27	Eyebolts.....91	Electrode Holder.....56
Panels.....20,46	Lashing Rings.....37,96-97	Glove.....105
Purlin Angle Clip.....71,102	Pins.....32,93-95	Hammers.....57
Purlin Chairs.....71,102	Snaps.....93	Helmet.....54
Rail.....31	Straps.....99	Jack Stands.....66
Weld Plates.....70-76	Turnbuckles.....90	Magnets.....55
ORNAMENTALS.....52-53	RING ADAPTERS.....15	Pipe Guide.....61
PANEL CLAMPS.....20,46	ROOF JACKS.....100	Regulators.....59-60
PINS	ROPE.....98	Rod.....62
Cotter.....94	ROUND BAR.....78	Soapstone.....56
Double R.....95	ROUND TUBE.....78	Striker.....56
Drop/Corral.....21	ROUND TUBE.....78	Tab/Plate.....70-76
Hitch.....31,93	SAFETY GEAR...54-55,104-106	Tools.....55-59
Linch.....94	SCREWS	Torch Tip.....58
R.....95	Fence/Lag Bolts.....46	Wire.....62
Snapper.....31,93	Roofing Screws.....101	WHEELS
PIPE CONNECTORS.....47	Screw Eye Bolt.....91	Caster.....24
PIPE GUIDES.....61	Trailer.....37	Cast Iron/BBQ.....23,69
PLASTIC TUBING PLUGS.....50	SNAPS.....93	Door Track.....23
POST CAPS.....48-50	SNAPPER PINS.....94	Gate Wheels.....22-24
POWER TOOLS	SPEARS/FINIALS.....52-53	Rubber Guide Roller.....22
Circular Saws.....85	SPRAY GUN.....106	V-Groove.....22
TurboShear.....80	SPRINGS	WHEEL BOXES.....22
PROMO GEAR.....110	Assorted Spring.....12,46	WINCHES.....98
PROPANE TORCH.....40,59	Handle.....25,69	WIRE
PUNCH PLATES.....72,103	SQUARE BAR.....79	Wire Brush.....57,65
PURLIN CLIPS.....71,102	SQUARE TUBE.....79	Wire Wheel.....65
R-PINS.....95	STAKE POCKET.....37	
RATCHET TIE-DOWNS.....99	STORE DISPLAYS.....108-109	
	STRAPPING/CLIP.....106	
	STRAPS	
	Butterfly.....99	
	Ratchet.....99	
	Winch.....98	
	STRETCH FILM.....106	
	STRONGHAND TOOLS.....82-83	
	T-POST DRIVER.....42	
	T-POST PULLER.....42	
	TAPE.....106	
	TANK HEADS.....68	
	TAPE MEASURES.....80	
	TIE LOOPS.....95	
	THERMOMETERS.....69	
	THREADED ROD.....78	
	TOOLS	
	Century.....55,81	
	Fencing.....42-43,80-81	
	Welding.....55-59	
	TORCH TIPS.....58	
	TRACK, OVERHEAD.....23	
	TRACK, WHEELS.....23	
	TRACTOR SEAT.....26	
	TRAILER PARTS.....32-37	
	TRAILER LIGHTS.....34-35	
	TUBING, PLUGS.....50	
	TURNBUCKLES.....90	
	URIAH PRODUCTS.....32-35	
	V-GROOVE WHEELS.....22	
	WEDGE ANCHORS.....101	
	WELD STUDS.....102	
	WELD TABS.....70-76	
	WELDING	
	Abrasive.....62-65	

NOTES:

ITEM NUMBER - PAGE NUMBER

Item # - Page #	Item # - Page #	Item # - Page #	Item # - Page #	Item # - Page #	Item # - Page #	Item # - Page #	Item # - Page #	Item # - Page #
45911 - 71, 102	46450 - 48	47595 - 48	47869 - 12	48080 - 23	48303 - 79	48452 - 31	48642 - 89	48895 - 92
45912 - 71, 102	46451 - 48	47596 - 48	47870 - 12	48081 - 23	48304 - 78	48457 - 43	48643 - 89	48896 - 91
45919 - 45	46452 - 48	47597 - 48	47882 - 99	48082 - 23	48306 - 78	48461 - 103	48644 - 89	48897 - 91
45938 - 48	46488 - 43	47598 - 48	47888 - 99	48089 - 106	48307 - 78	48462 - 103	48645 - 89	48898 - 91
45940 - 48	46489 - 43	47599 - 48	47889 - 99	48115 - 7	48309 - 78	48463 - 103	48646 - 89	48899 - 91
45942 - 48	46586 - 45	47605 - 48	47890 - 99	48116 - 7	48310 - 78	48485 - 101	48647 - 89	48900 - 91
45943 - 48	46597 - 45	47606 - 48	47891 - 98	48117 - 7	48312 - 78	48486 - 101	48648 - 89	48901 - 91
45944 - 48	46598 - 45	47607 - 48	47892 - 98	48145 - 6	48313 - 78	48487 - 101	48649 - 89	48902 - 91
45945 - 48	46640 - 43	47608 - 48	47893 - 98	48164 - 80	48315 - 78	48488 - 101	48650 - 89	48903 - 91
45946 - 48	46641 - 43	47609 - 48	47894 - 98	48195 - 37, 97	48316 - 78	48489 - 101	48651 - 89	48904 - 92
45947 - 48	46990 - 2	47619 - 3	47895 - 98	48196 - 37, 97	48318 - 78	48490 - 101	48652 - 89	48905 - 92
45948 - 48	46994 - 45	47623 - 43	47896 - 96	48197 - 37, 97	48319 - 78	48491 - 101	48657 - 21	48906 - 92
45949 - 48	46995 - 45	47638 - 9	47897 - 96	48198 - 37, 97	48321 - 78	48492 - 101	48658 - 21	48907 - 92
45950 - 48	46996 - 45	47639 - 9	47898 - 80	48206 - 5	48322 - 79	48493 - 101	48660 - 18	48908 - 92
45951 - 48	47016 - 1	47640 - 10	47899 - 80	48207 - 16	48324 - 79	48494 - 101	48663 - 106	48915 - 92
45952 - 48	47017 - 3, 36	47641 - 10	47900 - 80	48208 - 5, 16, 25	48325 - 79	48495 - 101	48713 - 8	48916 - 92
46065 - 68	47018 - 3, 36	47642 - 10	47901 - 80	48209 - 25	48327 - 79	48496 - 101	48785 - 3	48917 - 92
46116 - 68	47019 - 9	47643 - 12	47902 - 23	48217 - 8	48328 - 79	48497 - 101	48786 - 3	48918 - 92
46118 - 26, 40	47021 - 39	47644 - 12	47904 - 78	48218 - 8	48330 - 79	48498 - 101	48803 - 19	48919 - 92
46119 - 26, 40	47022 - 61	47645 - 9	47905 - 78	48219 - 8	48331 - 79	48499 - 101	48804 - 19	48920 - 92
46141 - 26	47023 - 61	47646 - 9	47935 - 42	48220 - 9	48333 - 79	48500 - 101	48806 - 19	48954 - 91
46158 - 77	47024 - 61	47647 - 9	47937 - 61	48236 - 9	48334 - 79	48501 - 101	48847 - 95	48988 - 20
46159 - 77	47025 - 61	47667 - 39	47939 - 18	48239 - 25, 69	48336 - 79	48502 - 101	48848 - 95	48989 - 20
46160 - 77	47026 - 61	47671 - 1	47940 - 18	48247 - 79	48337 - 79	48503 - 101	48850 - 95	48990 - 20
46161 - 77	47040 - 47	47675 - 45	47941 - 18	48249 - 79	48339 - 79	48504 - 101	48853 - 91	49016 - 96
46162 - 77	47041 - 47	47676 - 11	47942 - 18	48250 - 79	48340 - 79	48505 - 101	48854 - 91	49017 - 96
46163 - 77	47042 - 47	47677 - 44	47943 - 18	48252 - 79	48342 - 79	48506 - 101	48855 - 91	49018 - 96
46164 - 77	47043 - 47	47685 - 3	47948 - 85	48253 - 79	48343 - 79	48507 - 101	48856 - 91	49019 - 96
46165 - 77	47044 - 47	47686 - 3	47949 - 85	48255 - 79	48345 - 79	48508 - 101	48857 - 91	49020 - 19
46166 - 77	47045 - 47	47687 - 71	47950 - 85	48259 - 79	48346 - 79	48509 - 101	48858 - 91	49021 - 19
46168 - 77	47046 - 47	47688 - 71	47951 - 85	48261 - 79	48348 - 79	48510 - 101	48859 - 91	49022 - 19
46169 - 77	47047 - 47	47689 - 71	47952 - 85	48262 - 79	48352 - 78	48511 - 101	48860 - 91	49023 - 19
46170 - 77	47048 - 47	47690 - 97	47953 - 85	48264 - 79	48354 - 78	48512 - 101	48861 - 91	49026 - 101
46171 - 77	47049 - 47	47691 - 25, 69	47957 - 47	48265 - 79	48355 - 78	48513 - 101	48862 - 91	49027 - 101
46172 - 77	47050 - 10	47695 - 6	47958 - 47	48267 - 79	48357 - 78	48514 - 101	48868 - 91	49028 - 45
46173 - 77	47051 - 10	47696 - 6	47959 - 43	48271 - 79	48358 - 78	48523 - 100	48869 - 90	49087 - 90
46174 - 77	47052 - 7	47711 - 5	47961 - 104	48273 - 79	48360 - 78	48524 - 100	48870 - 90	49088 - 90
46175 - 77	47053 - 7	47716 - 61	47963 - 104	48274 - 79	48361 - 50	48525 - 100	48871 - 90	49089 - 90
46176 - 77	47054 - 7	47717 - 61	47989 - 104	48276 - 79	48362 - 85	48526 - 5	48872 - 90	49090 - 90
46177 - 77	47055 - 7	47718 - 61	47995 - 104	48277 - 79	48363 - 85	48595 - 5	48873 - 90	49091 - 90
46178 - 77	47056 - 7	47722 - 9	47996 - 104	48279 - 79	48371 - 13	48612 - 69	48874 - 90	49092 - 90
46179 - 77	47057 - 7	47750 - 4	48029 - 85	48280 - 79	48372 - 13	48613 - 69	48875 - 90	49093 - 90
46180 - 77	47058 - 7	47751 - 4	48036 - 17	48282 - 79	48373 - 13	48614 - 69	48877 - 91	49094 - 90
46181 - 77	47059 - 7	47768 - 12	48037 - 17	48283 - 79	48374 - 13	48627 - 24	48880 - 91	49095 - 90
46183 - 77	47061 - 22	47769 - 12	48038 - 23	48285 - 79	48405 - 50	48628 - 24	48881 - 91	49096 - 90
46184 - 77	47062 - 22	47779 - 85	48040 - 47	48286 - 79	48411 - 22	48629 - 24	48882 - 91	49097 - 92
46189 - 77	47088 - 11	47811 - 9	48041 - 47	48288 - 79	48419 - 99	48630 - 24	48884 - 91	49103 - 25
46190 - 77	47089 - 11	47816 - 105	48042 - 47	48289 - 79	48420 - 99	48631 - 5	48885 - 91	49104 - 1
46191 - 77	47117 - 2	47820 - 5	48043 - 47	48291 - 79	48421 - 99	48633 - 89	48886 - 92	49105 - 2
46192 - 77	47118 - 9	47821 - 22	48044 - 47	48292 - 79	48422 - 99	48634 - 89	48887 - 92	49106 - 4
46194 - 77	47135 - 7	47822 - 22	48046 - 96	48294 - 79	48423 - 99	48635 - 89	48888 - 92	49113 - 72, 103
46195 - 77	47339 - 2	47823 - 24	48047 - 96	48295 - 79	48429 - 99	48636 - 89	48890 - 92	49114 - 22
46196 - 77	47584 - 18	47853 - 80	48048 - 96	48297 - 79	48430 - 99	48637 - 89	48891 - 92	49116 - 72, 103
46198 - 77	47585 - 18	47854 - 23	48049 - 96	48298 - 79	48432 - 99	48638 - 89	48892 - 92	49120 - 70
46199 - 77	47586 - 18	47856 - 12	48059 - 50	48300 - 79	48433 - 99	48640 - 89	48893 - 92	49121 - 70
46442 - 45	47593 - 3	47857 - 12	48072 - 13	48301 - 79	48434 - 99	48641 - 89	48894 - 92	49122 - 70

ITEM NUMBER - PAGE NUMBER

Item # - Page #	Item # - Page #	Item # - Page #	Item # - Page #	Item # - Page #	Item # - Page #	Item # - Page #	Item # - Page #	Item # - Page #
49124 - 70	49396 - 93	49646 - 3	49805 - 25, 69	49896 - 96	49999 - 14	50081 - 50	50192 - 14	50311 - 16
49126 - 92	49397 - 93	49647 - 3	49806 - 31	49899 - 93	50001 - 96	50082 - 50	50197 - 37	50312 - 16
49127 - 92	49398 - 93	49649 - 3	49807 - 31	49901 - 93	50002 - 96	50083 - 50	50200 - 8	50313 - 16
49128 - 92	49399 - 93	49650 - 3	49809 - 39	49918 - 91	50003 - 108	50084 - 9	50201 - 8	50314 - 17
49130 - 12	49400 - 93	49654 - 14	49810 - 39	49919 - 91	50007 - 21	50085 - 7	50202 - 8	50316 - 17
49135 - 45	49401 - 93	49655 - 14	49811 - 39	49921 - 3	50008 - 44	50086 - 13	50203 - 8	50318 - 72, 103
49148 - 80	49402 - 93	49656 - 14	49812 - 39	49922 - 96	50009 - 44	50087 - 13	50204 - 22	50319 - 110
49154 - 80	49403 - 92	49659 - 96	49813 - 39	49923 - 96	50010 - 20	50091 - 24	50205 - 22	50321 - 14
49155 - 80	49407 - 8	49665 - 70	49821 - 31	49924 - 19	50012 - 95	50092 - 24	50209 - 22	50326 - 72, 103
49167 - 8	49408 - 8	49667 - 70	49822 - 42	49925 - 19	50013 - 95	50102 - 94	50210 - 109	50333 - 27
49173 - 23	49409 - 8	49669 - 109	49823 - 42	49926 - 70	50014 - 95	50104 - 106	50211 - 109	50334 - 110
49174 - 23	49410 - 8	49680 - 37	49824 - 42	49942 - 93	50015 - 101	50105 - 54	50212 - 98	50341 - 37, 97
49175 - 23	49411 - 8	49681 - 19	49829 - 6	49944 - 93	50016 - 106	50106 - 54	50213 - 98	50344 - 19
49182 - 90	49413 - 8	49682 - 19	49830 - 6	49945 - 93	50017 - 2	50107 - 54	50222 - 46	50345 - 97
49183 - 90	49414 - 8	49683 - 4	49831 - 2	49948 - 93	50018 - 7	50108 - 47	50223 - 46	50346 - 1
49196 - 78	49415 - 8	49685 - 105	49832 - 2	49949 - 93	50020 - 44	50109 - 47	50224 - 46	50347 - 1
49198 - 25, 69	49416 - 8	49686 - 106	49835 - 2	49953 - 93	50021 - 44	50110 - 97	50225 - 5	50348 - 1
49205 - 96	49417 - 8	49687 - 106	49836 - 1	49956 - 94	50022 - 37	50111 - 39	50227 - 104	50349 - 1
49207 - 109	49418 - 8	49688 - 105	49837 - 1	49957 - 94	50023 - 75	50112 - 39	50228 - 101	50350 - 46
49216 - 109	49420 - 106	49690 - 92	49838 - 25, 69	49958 - 94	50024 - 104	50115 - 106	50229 - 104	50351 - 46
49218 - 48	49427 - 4	49694 - 105	49840 - 72, 103	49959 - 94	50025 - 104	50118 - 3	50230 - 104	50352 - 46
49219 - 106	49428 - 25	49695 - 105	49841 - 45	49960 - 94	50026 - 27	50119 - 44	50231 - 104	50353 - 46
49328 - 2	49429 - 6	49697 - 37	49842 - 72, 103	49963 - 95	50030 - 100	50121 - 91	50232 - 104	50354 - 46
49333 - 27	49430 - 6	49709 - 22	49843 - 26	49964 - 44	50031 - 100	50122 - 95	50233 - 104	50380 - 1
49334 - 27	49431 - 97	49716 - 71	49844 - 22	49965 - 54	50032 - 100	50128 - 11, 36	50241 - 109	50381 - 1
49335 - 27	49432 - 25	49717 - 102	49847 - 75	49966 - 54	50033 - 100	50131 - 61	50248 - 109	50383 - 1
49336 - 30	49434 - 27	49718 - 102	49848 - 12	49967 - 54	50035 - 100	50134 - 3	50250 - 72, 103	50384 - 109
49337 - 30	49435 - 104	49719 - 102	49852 - 94	49968 - 54	50037 - 100	50135 - 21	50261 - 19	50388 - 102
49338 - 30	49436 - 104	49720 - 102	49853 - 94	49969 - 27	50038 - 100	50136 - 46	50263 - 69	50390 - 50
49339 - 26	49437 - 104	49721 - 102	49854 - 94	49970 - 18	50039 - 100	50137 - 46	50264 - 19	50391 - 37
49340 - 26	49444 - 48	49722 - 102	49855 - 94	49971 - 44	50042 - 14	50140 - 2	50265 - 19	50392 - 6
49341 - 26	49445 - 48	49723 - 102	49856 - 94	49972 - 21	50054 - 100	50141 - 6	50267 - 19	50393 - 6
49342 - 26	49450 - 25, 69	49724 - 102	49857 - 94	49973 - 44	50055 - 100	50142 - 96	50268 - 37	50400 - 23, 69
49345 - 18	49451 - 51	49725 - 102	49858 - 39, 94	49974 - 44	50058 - 102	50143 - 96	50269 - 37	50411 - 110
49346 - 17	49452 - 51	49726 - 102	49860 - 109	49975 - 21	50059 - 102	50144 - 96	50270 - 37	50412 - 68
49347 - 17	49453 - 51	49727 - 102	49862 - 55, 81	49976 - 19	50060 - 9	50145 - 14	50272 - 14	50413 - 68
49348 - 18	49454 - 51	49730 - 24	49869 - 21	49977 - 19	50061 - 12	50146 - 40, 59	50278 - 72, 103	50414 - 68
49351 - 18	49455 - 70	49732 - 31	49870 - 21	49978 - 19	50062 - 9	50149 - 3	50279 - 50	50415 - 68
49352 - 17	49456 - 70	49737 - 5	49873 - 91	49979 - 73	50063 - 24	50152 - 109	50280 - 50	50416 - 25
49353 - 17	49457 - 17	49742 - 46	49874 - 45	49980 - 70	50064 - 24	50153 - 10	50281 - 50	50417 - 4
49354 - 18	49458 - 18	49744 - 46	49875 - 2	49981 - 70	50065 - 16	50154 - 16	50287 - 2	50418 - 4
49357 - 18	49460 - 16	49748 - 46	49876 - 44	49982 - 70	50066 - 16	50155 - 16	50289 - 71	50423 - 17
49358 - 18	49461 - 16	49750 - 21	49877 - 101	49983 - 70	50067 - 95	50156 - 16	50292 - 11, 36	50424 - 16
49360 - 18	49467 - 45	49751 - 8	49878 - 101	49984 - 70	50068 - 10	50157 - 16	50293 - 10	50425 - 30
49362 - 96	49468 - 45	49752 - 8	49880 - 101	49985 - 70	50069 - 70	50158 - 37	50294 - 1	50426 - 92
49364 - 3	49478 - 6	49753 - 9	49881 - 101	49986 - 19	50070 - 3, 36	50162 - 50	50295 - 1	50427 - 45
49365 - 95	49488 - 47	49754 - 9	49883 - 101	49987 - 19	50071 - 3, 36	50163 - 50	50297 - 8	50428 - 26
49366 - 95	49491 - 69	49768 - 12	49884 - 101	49988 - 96	50072 - 9	50164 - 50	50298 - 17	50435 - 27
49367 - 95	49495 - 51	49786 - 46	49886 - 95	49989 - 97	50073 - 9	50165 - 50	50299 - 3	50436 - 27
49368 - 95	49496 - 51	49787 - 46	49888 - 95	49990 - 97	50074 - 9	50168 - 7	50300 - 25	50437 - 27
49369 - 95	49497 - 99	49794 - 101	49889 - 95	49991 - 97	50075 - 9	50179 - 10	50302 - 25	50438 - 27
49370 - 4	49499 - 99	49796 - 20	49890 - 96	49992 - 97	50076 - 9	50180 - 10	50304 - 2	50439 - 27
49383 - 106	49501 - 18	49797 - 90	49891 - 96	49994 - 10	50077 - 50	50181 - 10	50305 - 1	50440 - 50
49384 - 68	49503 - 23, 69	49798 - 90	49893 - 96	49995 - 10	50078 - 50	50182 - 39	50308 - 16	50441 - 50
49385 - 68	49504 - 23, 69	49802 - 7	49894 - 96	49997 - 101	50079 - 50	50188 - 80	50309 - 16	50442 - 50
49395 - 93	49645 - 3	49803 - 7	49895 - 96	49998 - 14	50080 - 50	50191 - 54	50310 - 16	50443 - 27

ITEM NUMBER - PAGE NUMBER

Item # - Page #	Item # - Page #	Item # - Page #	Item # - Page #	Item # - Page #	Item # - Page #	Item # - Page #	Item # - Page #	Item # - Page #
50444 - 71	50500 - 77	50632 - 1	70090 - 64	70146 - 63	70212 - 67	70282 - 54	80090 - 7	80170 - 49
50445 - 81	50501 - 77	50635 - 21	70091 - 64	70147 - 63	70213 - 67	70284 - 54	80091 - 7	80171 - 49
50446 - 81	50502 - 77	50636 - 23	70092 - 65	70148 - 63	70214 - 67	80000 - 68	80092 - 7	80172 - 49
50447 - 81	50503 - 77	50639 - 5, 42	70093 - 65	70149 - 63	70215 - 67	80001 - 51	80093 - 7	80173 - 49
50448 - 94	50504 - 25, 69	50641 - 26	70094 - 65	70150 - 63	70216 - 67	80002 - 51	80094 - 7	80174 - 49
50449 - 94	50511 - 102	50642 - 26	70095 - 65	70151 - 63	70217 - 67	80003 - 51	80095 - 7	80175 - 49
50450 - 94	50512 - 77	50643 - 26	70096 - 65	70152 - 63	70218 - 67	80004 - 51	80096 - 7	80176 - 49
50451 - 95	50513 - 77	50647 - 66	70097 - 64	70153 - 63	70226 - 55	80005 - 51	80097 - 7	80177 - 66
50452 - 95	50514 - 77	50648 - 66	70098 - 64	70154 - 63	70227 - 58	80006 - 51	80098 - 7	80178 - 7
50453 - 93	50524 - 94	50660 - 1	70099 - 64	70155 - 63	70228 - 58	80007 - 51	80099 - 68	80179 - 37
50454 - 93	50527 - 77	50669 - 42	70100 - 64	70156 - 63	70229 - 58	80008 - 51	80100 - 68	80187 - 55
50455 - 93	50528 - 77	50670 - 24	70101 - 64	70157 - 63	70230 - 58	80009 - 51	80101 - 14	80188 - 55
50456 - 93	50529 - 77	50671 - 78	70102 - 64	70158 - 63	70231 - 58	80010 - 51	80102 - 14	80189 - 55
50457 - 93	50530 - 19	50672 - 78	70103 - 64	70159 - 63	70232 - 58	80015 - 14	80103 - 14	80192 - 2
50458 - 93	50531 - 19	50673 - 78	70104 - 65	70160 - 56	70233 - 58	80017 - 84	80104 - 43	80193 - 37, 97
50459 - 93	50532 - 45	50680 - 26	70105 - 65	70161 - 56	70234 - 58	80018 - 84	80111 - 93	80194 - 69
50460 - 93	50535 - 38	50789 - 31	70106 - 65	70162 - 57	70235 - 58	80019 - 84	80119 - 14	80195 - 14
50461 - 39	50536 - 38	70022 - 57	70107 - 65	70163 - 56	70236 - 58	80020 - 84	80121 - 14	80196 - 14
50462 - 4	50537 - 38	70023 - 57	70108 - 65	70164 - 62	70237 - 58	80021 - 84	80124 - 6, 45	80203 - 66
50463 - 4	50538 - 68	70024 - 56	70109 - 65	70165 - 62	70238 - 58	80022 - 84	80125 - 6, 45	80204 - 66
50464 - 4	50539 - 105	70025 - 56	70110 - 65	70166 - 62	70239 - 58	80023 - 84	80126 - 6, 45	80206 - 14
50465 - 17	50540 - 105	70026 - 55	70111 - 65	70167 - 62	70240 - 58	80024 - 84	80127 - 6, 45	80209 - 44
50466 - 4	50541 - 106	70030 - 56	70112 - 65	70168 - 62	70241 - 58	80025 - 84	80130 - 108	80227 - 22
50467 - 7	50542 - 106	70031 - 56	70113 - 64	70169 - 62	70242 - 58	80026 - 36, 95	80131 - 103	80228 - 22
50468 - 7	50548 - 27	70032 - 56	70114 - 64	70170 - 62	70243 - 58	80027 - 36, 95	80132 - 103	80229 - 96
50469 - 80	50549 - 36	70033 - 57	70115 - 64	70171 - 62	70244 - 58	80028 - 45	80133 - 81	80230 - 43
50470 - 77	50553 - 4	70034 - 57	70116 - 64	70172 - 62	70246 - 57	80029 - 10	80134 - 81	80231 - 97
50471 - 77	50554 - 12	70035 - 57	70117 - 64	70173 - 56	70247 - 56	80032 - 17	80136 - 51	80232 - 68
50472 - 77	50559 - 25, 69	70036 - 57	70118 - 64	70174 - 56	70249 - 62	80033 - 17	80137 - 51	80234 - 106
50473 - 77	50570 - 103	70037 - 57	70119 - 64	70175 - 56	70250 - 62	80036 - 84	80138 - 51	80235 - 103
50474 - 77	50571 - 36	70038 - 57	70120 - 63	70176 - 62	70251 - 62	80039 - 84	80139 - 51	80236 - 11
50475 - 77	50572 - 36	70039 - 57	70121 - 63	70177 - 62	70252 - 54	80044 - 110	80140 - 51	80243 - 109
50476 - 77	50573 - 36	70040 - 57	70122 - 63	70178 - 62	70253 - 62	80045 - 92	80141 - 71, 102	80244 - 109
50477 - 77	50574 - 36	70043 - 55	70123 - 63	70179 - 62	70254 - 54	80051 - 18	80142 - 47	80245 - 48
50478 - 77	50575 - 36	70044 - 54	70124 - 63	70180 - 62	70255 - 54	80052 - 66	80144 - 78	80246 - 49
50479 - 77	50576 - 36	70045 - 55	70125 - 63	70181 - 62	70256 - 59	80053 - 71, 102	80145 - 78	80247 - 49
50480 - 77	50577 - 36	70047 - 55, 104	70126 - 63	70182 - 62	70257 - 59	80054 - 71, 102	80146 - 78	80248 - 71, 102
50481 - 77	50578 - 36	70050 - 58	70127 - 63	70183 - 58	70258 - 59	80055 - 71, 102	80147 - 78	80250 - 13
50482 - 77	50585 - 102	70051 - 58	70128 - 63	70184 - 58	70259 - 59	80061 - 8	80148 - 78	80251 - 11, 36
50483 - 77	50586 - 10	70052 - 58	70129 - 62	70185 - 58	70260 - 59	80062 - 8	80149 - 78	80267 - 50
50484 - 77	50587 - 80	70053 - 58	70130 - 62	70186 - 58	70261 - 59	80063 - 8	80151 - 19	80268 - 50
50485 - 77	50597 - 78	70055 - 55, 81	70131 - 62	70187 - 56	70262 - 59	80064 - 8	80153 - 19	80269 - 50
50486 - 77	50598 - 78	70056 - 55	70132 - 62	70188 - 56	70263 - 60	80065 - 8	80154 - 20	80270 - 50
50487 - 77	50599 - 78	70057 - 58	70133 - 62	70190 - 55, 104	70264 - 59	80066 - 72, 103	80155 - 20	80271 - 5, 42
50488 - 77	50600 - 78	70058 - 58	70134 - 62	70193 - 55	70265 - 59	80072 - 92	80156 - 20	80272 - 5, 42
50489 - 77	50601 - 78	70059 - 58	70135 - 62	70194 - 55	70266 - 60	80073 - 18	80158 - 48	80273 - 42
50490 - 77	50602 - 78	70060 - 58	70136 - 62	70195 - 56	70267 - 59	80077 - 44	80159 - 48	80274 - 47
50491 - 77	50603 - 78	70063 - 58	70137 - 62	70196 - 56	70268 - 59	80079 - 80	80160 - 48	80275 - 47
50492 - 77	50604 - 78	70066 - 62	70138 - 62	70199 - 56	70269 - 59	80080 - 80	80161 - 48	80276 - 24
50493 - 77	50605 - 78	70067 - 62	70139 - 63	70200 - 56	70270 - 59	80081 - 80	80162 - 48	80277 - 13
50494 - 77	50606 - 78	70072 - 62	70140 - 63	70202 - 65	70271 - 59	80082 - 102	80163 - 48	80278 - 13
50495 - 77	50607 - 78	70073 - 62	70141 - 63	70203 - 65	70272 - 57	80083 - 102	80165 - 66	80279 - 13
50496 - 77	50608 - 78	70074 - 62	70142 - 63	70204 - 65	70275 - 61	80084 - 102	80166 - 49	80280 - 8
50497 - 77	50619 - 45	70075 - 62	70143 - 63	70205 - 65	70279 - 54	80086 - 24	80167 - 49	80281 - 8
50498 - 77	50622 - 26	70080 - 62	70144 - 63	70206 - 65	70280 - 58	80088 - 98	80168 - 49	80283 - 84
50499 - 77	50631 - 44	70081 - 62	70145 - 63	70211 - 56	70281 - 54	80089 - 91	80169 - 49	80284 - 84

ITEM NUMBER - PAGE NUMBER

Item # - Page #	Item # - Page #	Item # - Page #	Item # - Page #	Item # - Page #	Item # - Page #	Item # - Page #	Item # - Page #	Item # - Page #
80285 - 84	80361 - 34	80443 - 50	80524 - 74	80580 - 73	80636 - 19	80724 - 109	80812 - 31	80875 - 87
80286 - 84	80362 - 35	80444 - 50	80525 - 74	80581 - 73	80638 - 10	80725 - 32, 93	80813 - 30	80876 - 87
80287 - 32	80363 - 51	80445 - 26	80526 - 74	80582 - 73	80639 - 31	80732 - 82	80814 - 31	80877 - 87
80288 - 32	80364 - 37, 97	80454 - 38	80527 - 74	80583 - 73	80640 - 31	80736 - 82	80815 - 30	80878 - 87
80289 - 32	80365 - 32	80455 - 38	80528 - 74	80584 - 73	80641 - 31	80737 - 82	80816 - 30	80879 - 87
80291 - 33	80366 - 32	80456 - 38	80529 - 74	80585 - 73	80642 - 31	80738 - 82	80817 - 31	80880 - 87
80292 - 32	80367 - 32	80457 - 103	80530 - 74	80586 - 73	80643 - 31	80739 - 83	80818 - 31	80881 - 87
80293 - 33	80368 - 32	80458 - 66	80531 - 74	80587 - 73	80654 - 29	80740 - 82	80819 - 31	80882 - 87
80294 - 32	80369 - 34	80459 - 38	80532 - 74	80588 - 73	80655 - 29	80741 - 82	80820 - 30	80883 - 87
80295 - 33	80370 - 34	80460 - 37, 97	80533 - 75	80589 - 73	80656 - 28	80742 - 83	80821 - 30	80884 - 87
80296 - 32	80371 - 34	80474 - 22	80534 - 75	80590 - 73	80657 - 28	80743 - 82	80824 - 78	80885 - 87
80297 - 33	80372 - 33	80475 - 22	80535 - 75	80591 - 73	80659 - 29	80744 - 82	80825 - 78	80886 - 87
80298 - 33	80373 - 58	80476 - 72, 103	80536 - 75	80592 - 73	80660 - 29	80745 - 82	80826 - 78	80887 - 87
80299 - 33	80374 - 58	80477 - 42	80537 - 75	80593 - 73	80662 - 29	80746 - 83	80827 - 78	80888 - 87
80300 - 33	80375 - 58	80478 - 71	80538 - 75	80594 - 73	80663 - 29	80747 - 83	80828 - 78	80889 - 88
80301 - 33	80376 - 58	80479 - 71	80539 - 75	80595 - 73	80664 - 28	80748 - 83	80829 - 78	80890 - 88
80302 - 33	80377 - 58	80480 - 71	80540 - 75	80596 - 73	80666 - 29	80749 - 83	80830 - 78	80891 - 88
80303 - 33	80378 - 58	80481 - 73	80541 - 75	80597 - 73	80667 - 28	80750 - 82	80832 - 87	80892 - 88
80304 - 33	80379 - 70	80482 - 73	80542 - 75	80598 - 73	80672 - 29	80751 - 82	80833 - 87	80893 - 88
80305 - 33	80380 - 70	80483 - 73	80543 - 75	80599 - 73	80673 - 29	80752 - 82	80834 - 87	80894 - 88
80306 - 33	80384 - 21	80484 - 73	80544 - 75	80600 - 73	80675 - 28	80753 - 82	80835 - 87	80895 - 88
80307 - 33	80388 - 25, 69	80486 - 73	80545 - 75	80601 - 72	80676 - 29	80754 - 83	80836 - 87	80896 - 88
80309 - 35	80393 - 96	80487 - 73	80546 - 76	80602 - 72	80677 - 28	80755 - 83	80837 - 87	80897 - 88
80310 - 35	80394 - 23	80488 - 73	80547 - 76	80603 - 72	80679 - 29	80756 - 83	80838 - 87	80898 - 88
80311 - 35	80395 - 45	80489 - 73	80548 - 76	80604 - 72	80680 - 29	80757 - 83	80839 - 87	80899 - 84
80312 - 35	80396 - 45	80490 - 73	80549 - 76	80605 - 72	80681 - 29	80758 - 83	80840 - 87	80900 - 84
80313 - 35	80397 - 34	80492 - 73	80550 - 76	80606 - 72	80686 - 68	80759 - 83	80841 - 87	80901 - 84
80314 - 35	80398 - 97	80493 - 73	80551 - 76	80607 - 72	80689 - 67	80760 - 83	80842 - 87	80902 - 84
80315 - 35	80402 - 20	80494 - 73	80552 - 76	80608 - 72	80690 - 12	80761 - 83	80843 - 87	80903 - 84
80316 - 35	80403 - 40	80495 - 73	80553 - 76	80609 - 72	80691 - 11	80762 - 83	80844 - 87	80904 - 84
80317 - 32	80404 - 40	80497 - 73	80554 - 76	80610 - 72	80692 - 29	80763 - 82	80845 - 87	80905 - 84
80318 - 32	80405 - 40	80499 - 73	80555 - 76	80611 - 72	80693 - 28	80764 - 83	80846 - 87	80906 - 109
80319 - 32	80406 - 40	80500 - 73	80556 - 75	80612 - 72	80695 - 28	80765 - 83	80847 - 86	80907 - 109
80320 - 32	80407 - 40	80501 - 73	80557 - 75	80613 - 72	80698 - 22	80767 - 22	80848 - 86	80908 - 23
80321 - 32	80408 - 40	80502 - 73	80558 - 75	80614 - 72	80699 - 22	80768 - 96	80849 - 87	80909 - 86
80322 - 33	80411 - 71, 102	80503 - 72	80559 - 75	80615 - 74	80700 - 36	80769 - 96	80850 - 88	80910 - 86
80323 - 32	80412 - 71, 102	80504 - 72	80560 - 75	80616 - 74	80704 - 80	80770 - 11, 36	80851 - 88	80911 - 86
80325 - 109	80415 - 11	80505 - 72	80561 - 75	80617 - 74	80705 - 11	80775 - 50	80852 - 88	80912 - 86
80326 - 55, 81	80418 - 104	80506 - 72	80562 - 75	80618 - 74	80706 - 10	80776 - 50	80853 - 88	80913 - 86
80327 - 55, 81	80424 - 15	80507 - 72	80563 - 75	80619 - 74	80707 - 11	80777 - 50	80854 - 88	80914 - 86
80332 - 81	80425 - 15	80508 - 72	80564 - 75	80620 - 74	80708 - 10	80778 - 50	80855 - 88	80915 - 86
80333 - 81	80426 - 15	80509 - 72	80565 - 75	80621 - 74	80709 - 10	80779 - 3, 36	80856 - 88	80916 - 86
80334 - 81	80427 - 15	80510 - 72	80566 - 75	80622 - 74	80710 - 10	80787 - 84	80857 - 88	80917 - 86
80335 - 81	80428 - 15	80511 - 72	80567 - 75	80623 - 74	80711 - 9	80790 - 84	80858 - 88	80918 - 86
80336 - 81	80429 - 15	80512 - 72	80568 - 75	80624 - 74	80712 - 17	80799 - 27	80859 - 88	80919 - 86
80349 - 19	80430 - 15	80513 - 72	80569 - 76	80625 - 50	80713 - 17	80800 - 78	80860 - 88	80920 - 86
80351 - 7	80431 - 15	80514 - 72	80570 - 76	80626 - 33	80714 - 17	80801 - 66	80861 - 88	80921 - 86
80352 - 34	80432 - 15	80515 - 72	80571 - 76	80627 - 43	80715 - 10	80802 - 66	80862 - 88	80922 - 86
80353 - 34	80433 - 15	80516 - 72	80572 - 76	80628 - 43	80716 - 10	80803 - 103	80863 - 88	80923 - 86
80354 - 34	80434 - 15	80517 - 74	80573 - 76	80629 - 43	80717 - 11	80805 - 21	80864 - 88	80924 - 86
80355 - 34	80435 - 15	80518 - 74	80574 - 76	80630 - 43	80718 - 11	80806 - 68	80865 - 87	80925 - 86
80356 - 34	80436 - 15	80519 - 74	80575 - 76	80631 - 100	80719 - 17	80807 - 68	80866 - 87	80926 - 86
80357 - 34	80437 - 15	80520 - 74	80576 - 76	80632 - 34	80720 - 17	80808 - 68	80867 - 87	80927 - 86
80358 - 34	80438 - 15	80521 - 74	80577 - 76	80633 - 96	80721 - 10	80809 - 71, 102	80868 - 87	80928 - 86
80359 - 35	80440 - 5	80522 - 74	80578 - 76	80634 - 40	80722 - 10	80810 - 30	80873 - 87	80929 - 86
80360 - 34	80442 - 50	80523 - 74	80579 - 73	80635 - 40	80723 - 43	80811 - 30	80874 - 87	80930 - 86

ITEM NUMBER - PAGE NUMBER

Item # - Page #	Item # - Page #	Item # - Page #	Item # - Page #
80931 - 86	81006 - 77	81136 - 105	00102 - 53
80932 - 86	81007 - 77	81137 - 105	00104 - 52
80933 - 86	81008 - 77	81138 - 105	00105 - 52
80934 - 86	81009 - 77	81139 - 105	00106 - 49
80935 - 86	81010 - 77	81140 - 105	00107 - 49
80936 - 86	81011 - 77	81141 - 105	00108 - 49
80937 - 86	81012 - 77	81142 - 105	00169 - 51
80938 - 86	81013 - 77	81537 - 38	00170 - 51
80939 - 86	81014 - 77	K0002 - 22	00171 - 51
80940 - 86	81015 - 77	00001 - 53	00172 - 51
80941 - 86	81016 - 77	00002 - 53	00173 - 51
80942 - 86	81017 - 77	00003 - 52	00181 - 52
80943 - 86	81018 - 77	00004 - 52	00182 - 51
80944 - 86	81019 - 77	00005 - 53	00183 - 51
80945 - 86	81020 - 77	00006 - 53	
80946 - 86	81021 - 77	00007 - 52	
80947 - 86	81022 - 77	00008 - 53	
80948 - 86	81023 - 77	00009 - 52	
80949 - 86	81024 - 77	00010 - 52	
80950 - 86	81025 - 77	00011 - 53	
80951 - 86	81026 - 77	00012 - 53	
80952 - 86	81027 - 77	00013 - 53	
80953 - 86	81028 - 77	00014 - 52	
80954 - 86	81029 - 77	00015 - 49	
80955 - 86	81030 - 77	00016 - 49	
80956 - 86	81031 - 77	00017 - 49	
80957 - 86	81032 - 77	00018 - 49	
80958 - 86	81033 - 77	00019 - 49	
80959 - 86	81034 - 77	00020 - 49	
80960 - 86	81035 - 77	00021 - 49	
80961 - 86	81036 - 77	00022 - 49	
80962 - 86	81037 - 77	00023 - 49	
80963 - 86	81038 - 77	00024 - 49	
80964 - 86	81039 - 77	00025 - 49	
80965 - 86	81040 - 77	00026 - 49	
80966 - 86	81041 - 77	00027 - 49	
80967 - 88	81042 - 77	00028 - 52	
80974 - 40	81043 - 77	00029 - 49	
80975 - 25,69	81045 - 39	00030 - 49	
80976 - 38	81046 - 81	00031 - 49	
80977 - 14	81047 - 14	00036 - 52	
80978 - 43	81048 - 14	00039 - 49	
80979 - 23	81052 - 81	00040 - 49	
80980 - 68	81053 - 69	00075 - 53	
80981 - 36,69	81064 - 58	00076 - 53	
80982 - 36,69	81069 - 26	00077 - 52	
80983 - 36,69	81070 - 26	00079 - 53	
80984 - 12	81073 - 47	00080 - 53	
80986 - 14	81097 - 43	00082 - 52	
80987 - 109	81129 - 105	00083 - 52	
80988 - 109	81130 - 105	00086 - 52	
80989 - 40	81131 - 105	00087 - 53	
80998 - 32	81132 - 105	00088 - 52	
81003 - 77	81133 - 105	00093 - 53	
81004 - 77	81134 - 105	00098 - 53	
81005 - 77	81135 - 105	00099 - 53	

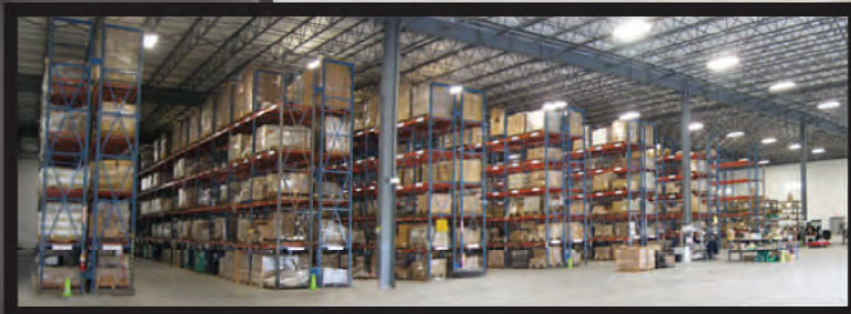
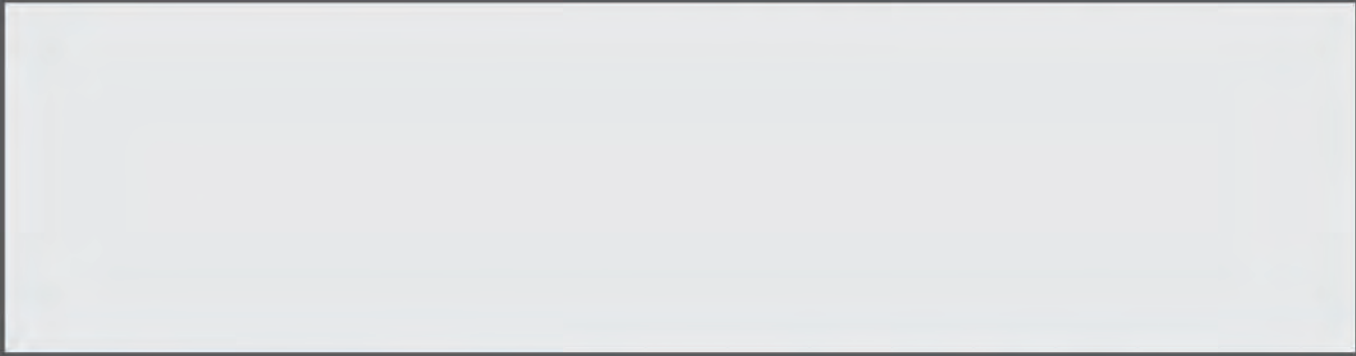

SPRING CREEK™ PRODUCTS

1-866-651-6702 • 325-651-9558
www.springcreekproducts.com